

Antis

sistema giorno / day system



Alf DaFre®

Antis

Alf DaFre®

**ANTIS è un sistema libreria per la zona giorno
caratterizzato dalla libertà di scelta in altezza
e di posizione degli elementi
con la possibilità di creare molteplici configurazioni.
Ogni elemento Antis è posizionabile liberamente,
sia nel numero sia all'altezza desiderata.**

**La vera caratteristica della libreria è
l'esclusivo e semplice sistema di aggancio degli elementi
grazie al montante in alluminio privo di fori
o agganci prefissati, che permette di poter cambiare
nel tempo la posizione degli elementi.**

ANTIS is a bookcase unit for your living space that can be freely built. You choose the height and position of the different elements to create many configurations. Each Antis component can be positioned freely at your preferred height, and you can use as many components as you like. Most importantly, this bookcase offers an exclusive, simple hook mechanism for attaching the elements: an aluminium upright with no prefixed hooks or holes, meaning you can move things around whenever you like.

ANTIS es un sistema de librería para la zona de día caracterizado por la posibilidad de elegir libremente la altura y la posición de los elementos, permitiendo crear diversas configuraciones. Cada elemento Antis se puede colocar con libertad, en la cantidad deseada y a la altura preferida. Lo verdaderamente importante de la librería es el sistema de enganche de los elementos, exclusivo y sencillo, gracias al montante de aluminio sin agujeros ni enganches prefijados, que permite cambiar de posición los elementos más adelante.

ANTIS est un système de bibliothèque pour la zone jour caractérisé par la liberté de choix en hauteur et de position des éléments avec la possibilité de créer de multiples configurations. Chaque élément Antis peut être positionné librement, aussi bien en nombre qu'à la hauteur souhaitée. La vraie chose importante de la bibliothèque est l'exclusif et simple système d'accrochage des éléments grâce au montant en aluminium sans trous ni accrochages préfixés, permettant de changer au fil du temps la position des éléments.

ANTIS ist ein Regalsystem für den Wohnbereich, bei dem die Höhe und Position der Elemente frei wählbar ist und eine Vielzahl von Kombinationen ermöglicht. Die einzelnen Elemente von Antis können frei positioniert werden, so dass beliebig viele Elemente in jeder gewünschten Höhe miteinander kombiniert werden können. Das Besondere dieses Regalsystems ist jedoch das exklusive und einfache Befestigungssystem der Elemente mit Hilfe des Aluminiumpfosten ohne Löcher oder vorgefertigte Haken, mit dem die Position der Elemente nach Belieben geändert werden kann.

ANTIS - система книжных шкафов для гостиной, характеризующаяся свободой выбора высоты и положения элементов с возможностью создания многочисленных конфигураций. Каждый элемент Antis может быть свободно позиционирован, как в отношении количества, так и желаемой высоты. Отличительной особенностью книжного шкафа является эксклюзивная и простая система крепления элементов, благодаря алюминиевой стойке без предварительно заданных отверстий или крепежа, что позволяет со временем изменять положение элементов.

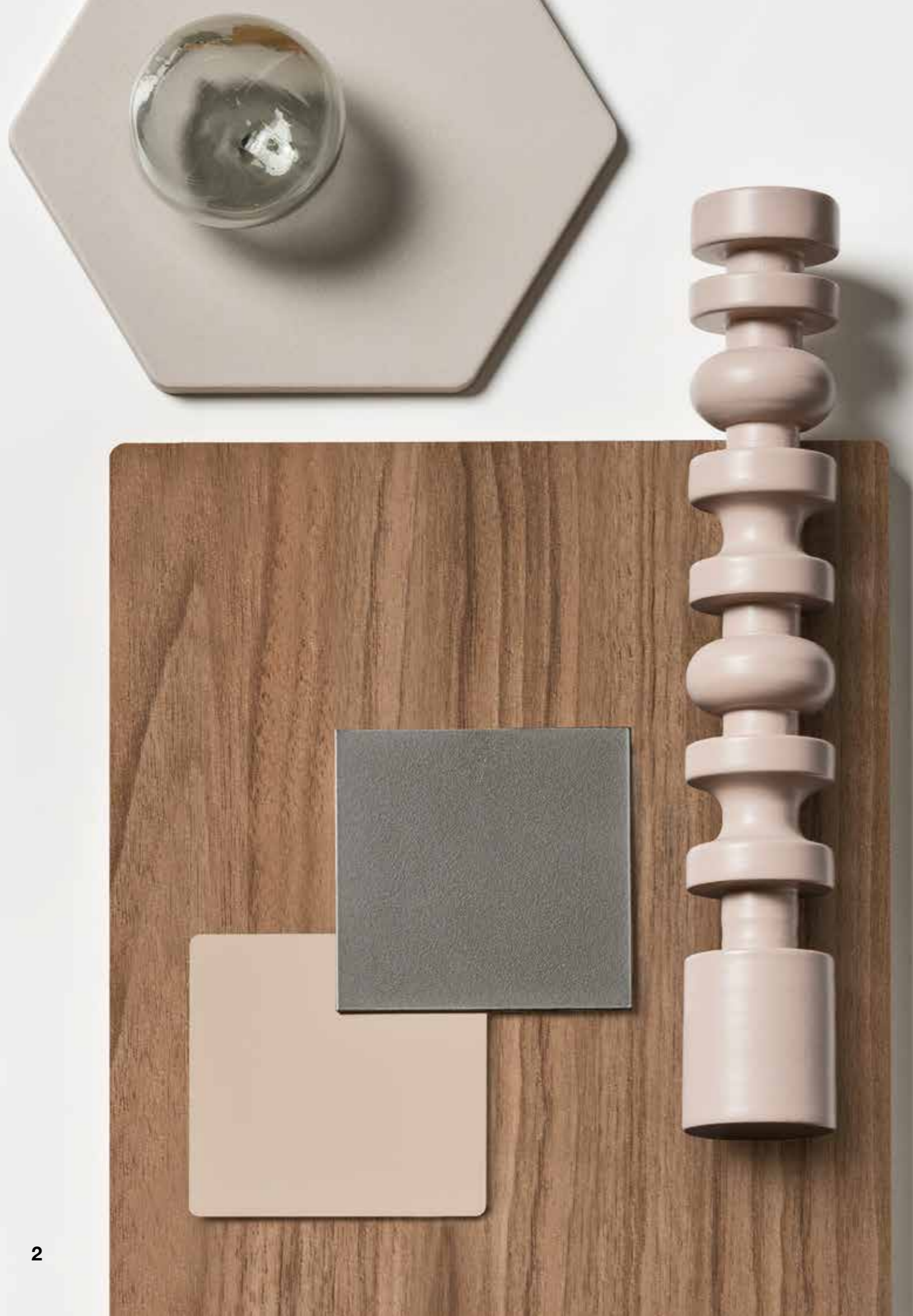

Antis

A modo mio
My way



L394 P46,4 H300

→ IT

Struttura verniciato Moka Shine
Mensole e Contenitori
Nobilitato Noce naturale
Porta TV Moka Shine
Poltroncine **RAKU**
Tavolini **MALMO**
Divano **COPENAGHEN**
(Per questi articoli vedi
COMPLEMENTI)

→ EN

Structure Moka Shine painted
Shelves and storage units
Noce naturale surfaced
TV unit Moka Shine
RAKU armchairs
MALMO occasional tables
COPENAGHEN sofa
(Please see COMPLEMENTS
for these items)



→ **IT**
Porta TV orientabile,
rotazione possibile
fino a 180° (in caso di
 libreria a soffitto/bifacciale).

→ **EN**
Adjustable TV unit, 180°
rotation (for floor-to-ceiling/
 double-sided bookcases).



L463 P44 H272

→ IT

Struttura verniciato Moka Shine

Mensole laccato opaco Tortora

Mensole vetro trasparente
grigio

Contenitori laccato opaco /
lucido Tortora

Contenitori VAS laccato opaco
Tortora e **box interni** rivestiti in
cuoio 1031

→ EN

Structure Moka Shine painted

Shelves Matt Tortora lacquer

Shelves Grigio transparent
glass

Storage units Matt/high-gloss
Tortora lacquer

VAS storage units Matt Tortora
lacquer and **internal storage
units** 1031 leather upholstery



L498 P46,4 H300

→ **IT**

Struttura verniciato Moka Shine
Mensole Fashion wood rovere Ghiro
Contenitori Fashion wood rovere Ghiro
e **maniglia C15** verniciato Moka Shine
FYRA tavolo
CORIUM sedie
(Per questi articoli vedi COMPLEMENTI)

→ **EN**

Structure Moka Shine paint
Shelves Ghiro oak Fashion Wood
Storage units Ghiro oak Fashion Wood
and **C15 handle** Moka Shine painted
FYRA table
CORIUM chairs
(Please see COMPLEMENTS for
these items)









L395,8 P41,6 H300

→ **IT**

Struttura verniciato Moka Shine

Mensole Fashion wood rovere
Fossile

Mensole vetro trasparente
Grigio

ALIANTE tavolo

CORIUM sedie

(Per questi articoli vedi
COMPLEMENTI)

→ **EN**

Structure Moka Shine painted

Shelves Fossile oak Fashion
Wood

Shelves Grigio transparent glass

ALIANTE table

CORIUM chairs

(Please see COMPLEMENTS for
these items)

Antis

Il colore è servito
Your colour is served

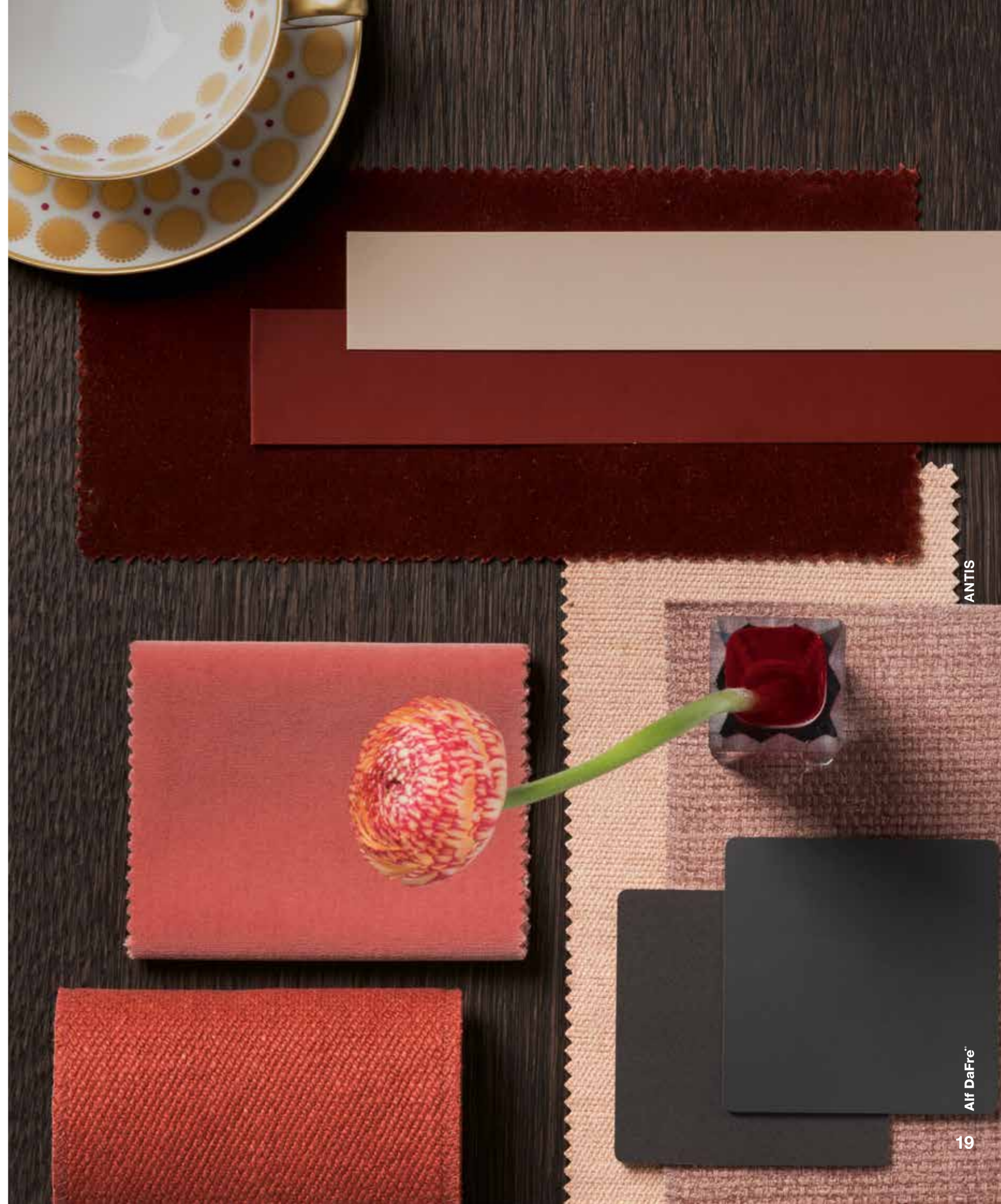



comp. Antis / 05



L463 P47,5 H240

→ **IT**
Struttura verniciato Moka Shine
Mensole laccato opaco
Amaranto
Contenitori VAS laccato opaco
Amaranto e **box interni** rivestiti
in cuoio 1031
Contenitori laccato opaco
Amaranto
RAKU divanetto e panca
(Per questi articoli vedi
COMPLEMENTI)

→ **EN**
Structure Moka Shine painted
Shelves Matt Amaranto
lacquer
VAS storage units Matt
Amaranto lacquer and **internal
boxes** 1031 leather upholstery
Storage units Matt Amaranto
lacquer
RAKU sofa and bench
(Please see COMPLEMENTS
for these items)



comp. **Antis / 06**

L399 P37,9 H256

→ **IT**

Struttura verniciato Moka Shine

Mensole laccato opaco Arena

Mensole vetro trasparente
Grigio

Contenitori VAS laccato opaco

Arena e **box interni** rivestiti in
cuoio 1031

FUSELLO tavolo

SHIFT sedie

(Per questi articoli vedi
COMPLEMENTI)

→ **EN**

Structure Moka Shine

Painted

Shelves Matt Arena lacquer

Shelves Grigio transparent
glass

VAS storage units Matt

Arena lacquer and **internal**

boxes 1031 leather

upholstery

FUSELLO table

SHIFT chairs

(Please see COMPLEMENTS
for these items)



L527 P47,5 H208

→ IT

Struttura verniciato Moka Shine
Mensole Fashion wood rovere
Fossile / laccato opaco Nero
Contenitori Fashion wood
rovere Fossile / laccato opaco
Nero
CEPPO tavolino
(Per questo articolo vedi
COMPLEMENTI)

→ EN

Structure Moka Shine
painted
Shelves Fossile oak Fashion
Wood / matt Nero lacquer
Storage units Fossile oak
Fashion Wood / matt Nero
lacquer
CEPPO occasional table
(Please see COMPLEMENTS
for this item)

comp. **Antis / 07**

comp. 07



ANTIS



L332,5 P63,5 H192

→ **IT**
Struttura verniciato Moka Shine
Mensole laccato opaco Nero
Contenitori laccato opaco Modica
Scrivania laccato opaco Modica
CORIUM sedia
(Per questo articolo vedi COMPLEMENTI)

→ **EN**
Structure Moka Shine painted
Shelves Matt Nero lacquer
Storage units Matt Modica lacquer
Desk Matt Modica lacquer
CORIUM chair
(Please see COMPLEMENTS for this item)

Dati tecnici / Technical data

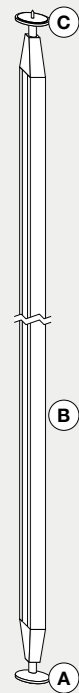

Montante a soffitto / bifacciale
Ceiling upright / double-sided

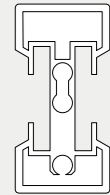

Sezione montante a soffitto / bifacciale
Cross-section of ceiling upright / double-sided

A / Piede a terra Ø 5,7 cm (in appoggio a terra).
N.B. permette la regolazione in altezza di 1 cm.
Foot (floor) Ø 5.7 cm (floor-standing).
N.B. adjust the unit height by 1 cm.

B / Profilo per montante a soffitto in estruso di alluminio verniciato.
Coated extruded aluminium profile for ceiling upright.

C / Piede a soffitto Ø 5,7 cm (fissato con vite al soffitto).
N.B. permette la regolazione in altezza di 1 cm.
Foot (ceiling) Ø 5.7 cm (screwed to the ceiling)
N.B. adjust the unit height by 1 cm.

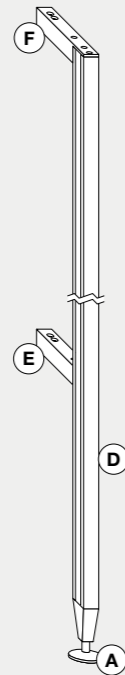

Montante a parete
Wall upright

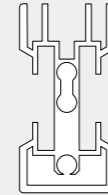

Sezione montante a parete
Cross-section of wall upright

A / Piede a terra Ø 5,7 cm (in appoggio a terra).
N.B. permette la regolazione in altezza di 1 cm.
Foot (floor) Ø 5.7 cm (floor-standing)
N.B. adjust the unit height by 1 cm.

D / Profilo per montante a parete in estruso di alluminio verniciato.
Coated extruded aluminium profile for wall upright.

E / Traverso centrale in estruso di alluminio verniciato (sempre presente a prescindere dall'altezza).
Coated extruded aluminium central crosspiece (always required irrespective of the unit height).

F / Traverso superiore in estruso di alluminio verniciato.
Coated extruded aluminium top crosspiece.

Esempio di composizione / Composition example

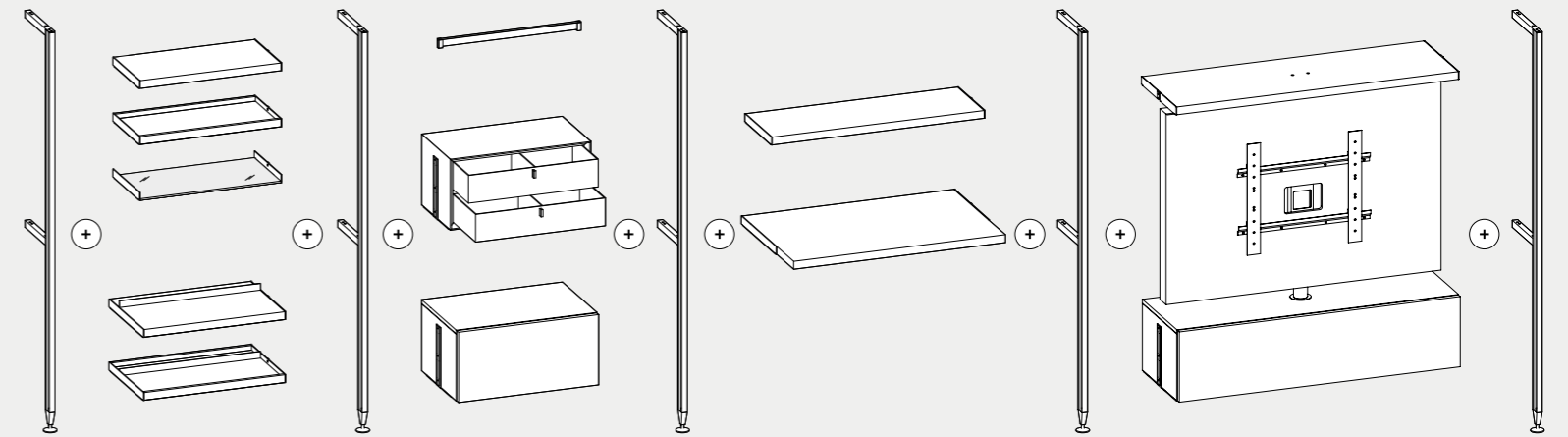

Mensola legno sp. 3,5 cm con staffe in metallo verniciato Moka Shine.
/ Wooden shelf 3.5 thick with Moka Shine painted metal brackets.

Tubo appendiabiti.
/ Clothes rail.

Mensola legno sp. 1,4 cm in folding con staffe in metallo verniciato Moka Shine.
/ Folded wooden shelf 1.4 thick with Moka Shine painted metal brackets.

NOVITÀ: porta TV orientabile
/ New: Adjustable TV unit 180°

Mensola in vetro trasparente grigio con staffe in metallo verniciato Moka Shine.
/ Grigio transparent glass shelf with Moka Shine painted metal brackets.

Scrivania sp. 3,5 cm con staffe in metallo verniciato Moka Shine.
/ Desk 3.5 thick with Moka Shine painted metal brackets.

Mensola legno sp. 3,5 cm e portascarpe con staffe in metallo verniciato Moka Shine.
/ Wooden shelf 3.5 cm thick and shoe rack with Moka Shine painted metal brackets.

Contenitore VAS con staffe in metallo verniciato Moka Shine.
/ VAS storage unit with Moka Shine painted metal brackets.

Mensola legno sp. 1,4 cm in folding e portascarpe con staffe in metallo verniciato Moka Shine.
/ Folded wooden shelf 1.4 cm thick and shoe rack with Moka Shine painted metal brackets.

Box interno per contenitore VAS.
/ Internal box for VAS storage unit.

Contenitore finito con staffe in metallo verniciato Moka Shine.
/ Finished storage unit with Moka Shine painted metal brackets.

Antis

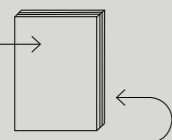

Day collection



Antis sistema giorno / day system

art direction
Bruna Vaccher
Genny Canton

graphic
Genny Canton Studio

photo (Antis)
Paolo Contratti

styling
Rosanna Bignucolo
Claudia Barberi

digital image
Nudesign (Day collection/Antis)
Genny Canton Studio (Antis)

separations
Luce srl

print
Sincromia

stampato
Febbraio 2021



Verifica le finiture disponibili sul nostro sito internet. / Check the finishes available on our website. / Consulte los acabados disponibles en nuestro sitio web. / Vérifiez les finitions disponibles sur notre site internet. / Überprüfen Sie auf unserer Webseite, ob die gewünschte Ausführung erhältlich ist. / Познакомьтесь с вариантами отделки на нашем интернет-сайте www.alfdafre.it

ALF UNO s.p.a. si riserva di apportare in qualsiasi momento modifiche a prodotti, misure e materiali, che ritenesse utili per esigenze di carattere produttivo e commerciale. Per essere sempre aggiornati vi invitiamo a consultare il nostro sito internet www.alfdafre.it.

LE FINITURE

I materiali utilizzati dalla nostra azienda sono selezionati tra i più affidabili per applicazione e resa estetica. Nonostante questo devono considerarsi tollerabili alcune differenze dovute alle caratteristiche stesse di materiali come essenze naturali, vetri, laccature e all'artigianalità di alcune fasi del processo produttivo che da sempre è un nostro valore aggiunto. Inoltre alcune finiture possono subire nel tempo maturazioni dovute all'azione della luce e del tempo. È importante quindi specificare se nell'ordine vi sono sostituzioni o completamenti per valutare insieme il miglior modo di procedere. Le tonalità di colore e le finiture illustrate vanno considerate puramente indicative. Verificare sempre la fattibilità dell'abbinamento finiture consultando l'interno del listino.

ALF UNO s.p.a. reserves the right to make any changes to products, measurements and materials at any time deemed useful for manufacturing and sales purposes. To stay up to date at all times, please visit our website www.alfdafre.it.

FINISHES

The materials we use are selected among the most reliable products in terms of application and aesthetic rendering. Despite this, certain differences due to the very characteristics of materials such as natural wood finishes, glass and lacquers must be considered tolerable, as well as the hand-crafted nature of certain phases of the production process, which has always been one of our added values. In addition, some finishes may change over time, due to the effects of light and time. It is therefore important to specify whether there are replacements or completions in the order to assess the best way to proceed together. The finishes featured in this sample collection are purely indicative and are not available for all products. Please check in the price list if the finish is available for the chosen item. Orders will not be accepted for products with finishes not included in the price list. The colour shades and finishes illustrated herein are to be considered purely indicative. Always check the feasibility of finish combinations by consulting the price list contents.

world wide offices

CANADA & USA NORTH-EAST COAST
TEL. (416) 663-2223 - FAX (416) 663-2594
E-MAIL: alf@rosnerinternational.com

CENTRAL AMERICA - CARIBBEAN ISLANDS
TEL. (787) 786-9705 - FAX (787) 785-9835
E-MAIL: alvin@arodz.net

LOUISIANA-OKLAHOMA-TEXAS
TEL. (405) 204-4737
E-MAIL: parke@furniturestateresources.com

**ARIZONA-OREGON-WASHINGTON-NORTHERN
CALIFORNIA-ALASKA-COLORADO-UTAH-NEW
MEXICO-HAWAII**
TEL. (707) 291 2995
E-MAIL: corneliussen@aol.com

FLORIDA - ALABAMA
TEL. (321) 773-6982 - FAX (321) 773-8324
E-MAIL: lloydavisiii@aol.com

MID-WEST/SOUTH-EAST (EXCLUDING FLORIDA)
TEL. (310) 636-1199 - FAX (310) 636-4433
E-MAIL: bill@weisbergsales.com

U.S.A.: HIGH POINT SHOWROOM
(OPEN ONLY DURING FURNITURE MARKET DATES)
TEL. (336) 889-9027

NEVADA-SOUTHERN CALIFORNIA
E-MAIL: alf@alf.it

AUSTRALIA & NEW ZEALAND
TEL. (08) 9314 3999 - FAX (08) 9314 3777
E-MAIL: ross@merlino.com.au

MEXICO
TEL. (55) 5351-1348
E-MAIL: furniturezenteno@yahoo.com

AUSTRIA
TEL. +43(0)4240 20358 - FAX +43(0)4240 20370
E-MAIL: luca.zoldan@designphilosophy.org

GERMANY
TEL. +49 171 8043908
E-MAIL: roberto.sonego65@gmail.com

SWITZERLAND
TEL. +39 342 776 0752
E-MAIL: d.pagot@agentur2020.com

DENMARK
TEL. +45 20475875
E-MAIL: lehri@mail.dk

BELGIUM - LUXEMBOURG
TEL. +32 471726845
E-MAIL: jan@jmsa.be

NETHERLANDS
TEL. +31-655-191753
E-MAIL: arnold@hakse.com

EAST EUROPE
TEL. +39 3484064921
E-MAIL: caputomauro@libero.it

ICELAND
TEL. +354 5880640
E-MAIL: casa@casa.is

U.K. - IRELAND
TEL. + 44 7980019194
E-MAIL: design@atmosphere1102.com

FRANCE - BRETAGNE - NORMANDIE - CENTRE
TEL. 0033608423974
E-MAIL: contact@jmcsarl.fr

FRANCE - EST
TEL. 0033615436985
E-MAIL: ch.vidrin@wanadoo.fr

FRANCE - SUD-EST
TEL. 06 33 83 87 58
E-MAIL: fd.developpement@orange.fr

FRANCE - ILE DE FRANCE - NORD
TEL. 06 60 65 61 62
E-MAIL: decaix.christophe@wanadoo.fr

FRANCE - SUD-OUEST
TEL. 06 40 55 21 88
E-MAIL: tgjerd.gt@gmail.com

FRANCE - RHONE/ALPES
TEL. 0033689923725 - FAX 003346677294
E-MAIL: frederic.ac@orange.fr

HELLAS-CYPRUS
TEL. +39 0434 77199 - FAX +39 0434 779591
E-MAIL: luca.zoldan@designphilosophy.org

INDIA-SRI LANKA
TEL. +91 8041285290 - 91 9845636644
E-MAIL: keith@kreb.in

ALF GROUP MIDDLE-EAST REP. OFFICE
TEL. +961 4718160 - FAX +961 4718159
E-MAIL: info@alfme.com

POLAND
TEL. +48 618175994 - FAX +48 616429218
E-MAIL: karina@qualitaliana.pl

CSI E PAESI BALTICI
TEL. +7-812-3322934 - FAX +7-812-3322934
E-MAIL: office.spb@alf.it

ALGERIA - TUNISIA
E-MAIL: info@wallitaliandesign.it

SOUTH AFRICA
TEL. +27 0861777123 - FAX +27 0118262186
E-MAIL: les@alfsa.co.za

SPAIN - ANDALUCIA Y EXTREMADURA
TEL. +34 958818744 - FAX +34 958302251
E-MAIL: info@javiercastellon.com

SPAIN - CASTILLA Y LEON
TEL. +34983541003 - FAX +34983541003
E-MAIL: evaristorg@gmail.com

SPAIN - BARCELONA - CATALUNYA Y ANDORRA
TEL. +34 935531590 - FAX +34 935531590
E-MAIL: albert-miro-mauri@hotmail.com

SPAIN - VALENCIA, MURCIA Y CASTILLA LA MANCHA
TEL. +34 607 210 185
E-MAIL: jlhervas.vlc@gmail.com

SPAIN - MADRID
TEL. +34 607 363 016 - FAX +34 91 351 57 27
E-MAIL: e.sesenna@telefonica.net

**SPAIN - SORIA, LA RIOJA, MALLORCA,
MENORCA, IBIZA, FORMENTERA Y ASTURIAS**
E-MAIL: alf@alf.it

SPAIN - ARAGÓN
TEL. +34 650236594 - FAX +34 976598600
E-MAIL: davidmirandamoreno@gmail.com

**SPAIN - PAIS VASCO, LA RIOJA, NAVARRA Y
CANTABRIA**
TEL. +34 656 703 204
E-MAIL: iruoffice@iruoffice.com

PORTUGAL
TEL. +351 919 723 837
E-MAIL: alice.barroso@mail.telepac.pt

TURKEY
E-MAIL: alf@alf.it

INDONESIA - SINGAPORE
TEL. +65 91214415
E-MAIL: alberto.fantin@soluzioni.com.sg

TAIWAN - COREA DEL SUD - GIAPPONE
TEL. 0082 1086862707
E-MAIL: mattiazanini.alfitalia@gmail.com

Alf DaFre®

ALF UNO Spa
Via S. Pio X 17
31018 Francenigo di Gaiarine
Treviso, Italy
Tel. +39 0438 997111
Fax Italia +39 0438 997245
Fax estero +39 0438 997246
www.alfdafre.it alf@alf.it



ALF UNO Spa
è certificata **ISO 9001:2015**
ALF UNO Spa
is certified by the **ISO 9001:2015**