

# Store / Antis

cabine armadio / walk-in wardrobes



**Alf DaFrè®**

**Alf DaFre®**

## STORE

è una cabina armadio componibile  
composta da schienali attrezzabili.  
Offre grandi varietà compositive grazie  
all'ampia gamma di accessori disponibili.



STORE is a modular walk-in wardrobe made up of back panels that can be accessorised. It offers excellent variety for your composition, thanks to a wide range of available accessories.

STORE es un armario vestidor modular formado por paneles de pared equipables. Ofrece una gran variedad compositiva gracias a la amplia gama de accesorios disponibles.

STORE est une cabine armoire modulable composée de panneaux arrière pouvant être équipés. Elle offre de grande possibilité de composition grâce à l'ample gamme d'accessoires disponibles.

STORE ist ein modulares System für begehbare Kleiderschränke, das aus ausstattbaren Rückwänden besteht. Dank der umfassenden Auswahl an Zubehör bietet es große gestalterische Freiheit.

STORE представляет собой компонуюемую гардеробную с оснащаемыми задними стенками. Предлагает большие композиционные возможности благодаря широкой гамме имеющихся аксессуаров.

## ANTIS

è un sistema composto da "montanti"  
attrezzabili caratterizzato dalla libertà di  
scelta in altezza e di posizione degli elementi  
con la possibilità di creare molteplici  
configurazioni.

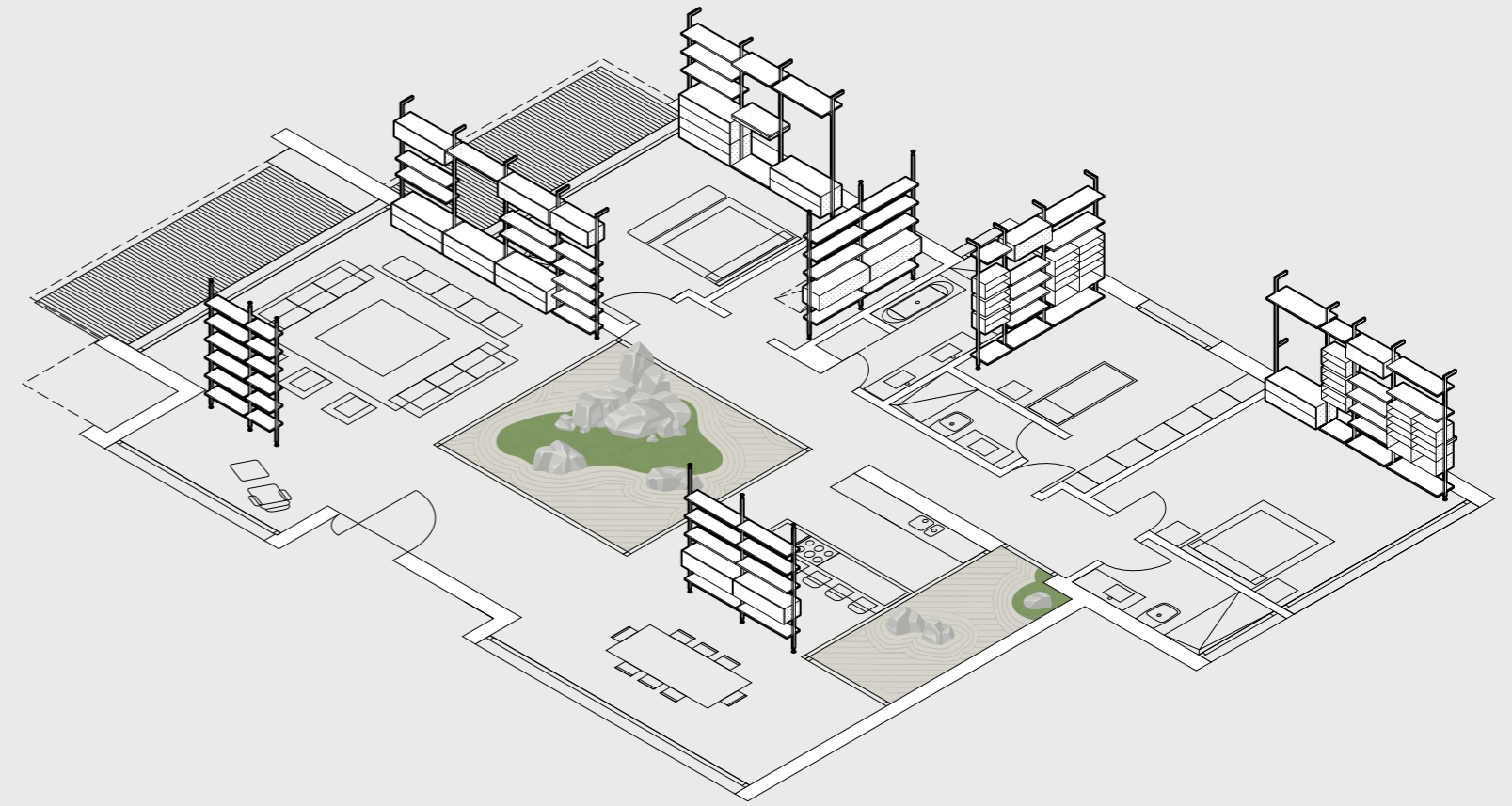

ANTIS is a system of "uprights" you can accessorise and build freely. You choose the height and position of the different elements to create infinite configurations.

ANTIS es un sistema formado por "montantes" equipables caracterizado por la posibilidad de elegir libremente la altura y la posición de los elementos, permitiendo crear diversas configuraciones.

ANTIS est un système composé de « montants » pouvant être équipés, caractérisé par la liberté de choix en hauteur et de position des éléments avec la possibilité de créer de multiples configurations.

ANTIS ist ein System, das aus ausstattbaren Montageleisten besteht. Es zeichnet sich besonders durch seine außergewöhnliche Flexibilität bei der Wahl der Höhe und der Position der Elemente sowie seine zahlreichen Kombinationsmöglichkeiten aus.

ANTIS - система из оснащаемых «стоек», характеризующаяся свободой выбора высоты и положения элементов с возможностью создания многочисленных конфигураций.



**STORE**  
è una cabina armadio componibile  
composta da schienali attrezzabili.  
Offre grandi varietà compositive grazie  
all'ampia gamma di accessori disponibili.

STORE is a modular walk-in wardrobe made up of back panels that can be accessorised. It offers excellent variety for your composition, thanks to a wide range of available accessories.

STORE es un armario vestidor modular formado por paneles de pared equipables. Ofrece una gran variedad compositiva gracias a la amplia gama de accesorios disponibles.

STORE est une cabine armoire modulable composée de panneaux arrière pouvant être équipés. Elle offre de grande possibilité de composition grâce à l'ample gamme d'accessoires disponibles.

STORE ist ein modulares System für begehbare Kleiderschränke, das aus ausstattbaren Rückwänden besteht. Dank der umfassenden Auswahl an Zubehör bietet es große gestalterische Freiheit.

STORE представляет собой компоную гардеробную с оснащаемыми задними стенками. Предлагает большие композиционные возможности благодаря широкой гамме имеющихся аксессуаров.



finiture / finishes  
Nobilitato Rovere bruno / Bruno oak surfaced  
Nobilitato Piasentina / Piasentina surfaced  
Laccato opaco Nude e Pacifico / Matt Nude and Pacifico lacquer



L298,4 X 426 P59,6 H277

→ IT

**Schienali** Nobilitato Piasentina, Nobilitato rovere Bruno  
**Ripiani** Laccato opaco Nude, Nobilitato rovere Bruno, Laccato opaco Pacifico,  
**Cassettiere** Nobilitato rovere Bruno, Vetro trasparente Grigio con **maniglia T16** verniciato Moka Shine  
**Scrittoio** Nobilitato rovere Bruno  
**Pensili a giorno** Nobilitato rovere Bruno  
**Luci a led** su ripiani e **tubi appendiabiti** verniciato Moka Shine  
**FIL** specchiera (per questo articolo vedi LETTI E GRUPPI NOTTE)  
**DENNY** pouf, **RAKU** panca (per questi articoli vedi COMPLEMENTI)

→ EN

**Back panels** Piasentina surfaced, Bruno oak surfaced  
**Shelves** Matt Nude lacquer, Bruno oak surfaced, Matt Pacifico lacquer,  
**Drawer units** Bruno oak surfaced, Grigio transparent glass with **T16 handle** painted in Moka Shine  
**Desk** Bruno oak surfaced  
**Open wall units** Bruno oak surfaced  
**LED lighting** on shelves and **clothes rails** painted in Moka Shine  
**FIL** mirror (Please see BEDS AND STORAGE UNITS for this item)  
**DENNY** footstool, **RAKU** bench (Please see COMPLEMENTS for these items)



finiture / finishes  
Fashion wood rovere Naturale / Naturale oak Fashion Wood  
Fashion wood rovere Ghiro / Ghiro oak Fashion Wood

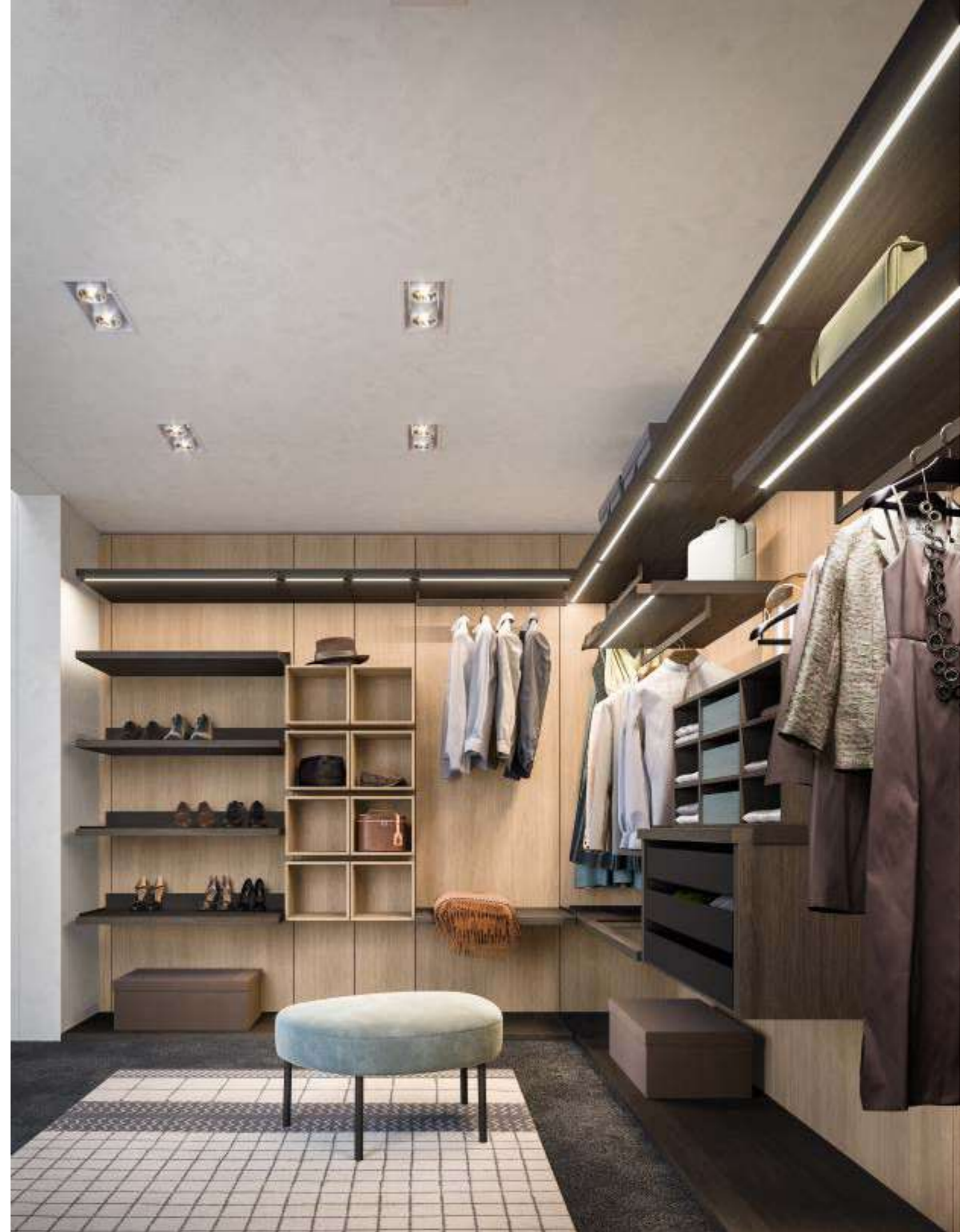

L298,5 X 374 P57,6 H255

→ IT

**Schienali** Fashion wood rovere Naturale

**Ripiani** Fashion wood rovere Ghio

**Cassettiera** Fashion wood rovere Naturale con **vassoio estraibili** telaio alluminio finitura Grigio fumo

**Raster** Fashion wood rovere Ghio con **scatole** rivestite in tessuto

**Pensili a giorno** Fashion wood rovere Naturale

**Luci a led** su ripiani e **tubi appendiabiti** verniciato Moka Shine

**JETTY** letto

(per questo articolo vedi LETTI E GRUPPI NOTTE)

**MALMO** tavolino, **RAKU** pouf (per questi articoli vedi COMPLEMENTI)

→ EN

**Back panels** Naturale oak Fashion Wood

**Shelves** Ghio oak Fashion Wood

**Drawer unit** Naturale oak Fashion Wood with **pull-out trays** aluminium frame in Grigio Fumo finish

**Cubby-hole unit** Ghio oak Fashion Wood with fabric-upholstered **boxes**

**Open wall units** Naturale oak Fashion Wood

**LED lighting** on shelves and **clothes rails** painted in Moka Shine

**JETTY** bed

(Please see BEDS AND STORAGE UNITS for this item)

**MALMO** occasional table, **RAKU** footstool (Please see COMPLEMENTS for these items)







finiture / finishes  
Nobilitato Eukalipto cenere / Eukalipto Cenere surfaced  
Laccato opaco Aghata / Matt Aghata lacquer



L352,8 P59,3 H227

→ **IT**  
**Schienali** Nobilitato Eukalipto cenere  
**Schienale** con specchio Grigio  
**Ripiani** Laccato opaco Aghata  
**Cassettiere** Laccato opaco Aghata e **Maniglia**  
 pomolo pelle verniciato Moka Shine / cuoio Grigio  
**Luci a led** su ripiani  
**DENNY** pouf, **RAKU** panca  
 (per questi articoli vedi COMPLEMENTI)

→ **EN**  
**Back panels** Eukalipto Cenere surfaced  
**Back panel** with Grigio mirror  
**Shelves** Matt Aghata lacquer  
**Drawer units** Matt Aghata lacquer and leather  
 knob **handle** painted in Moka Shine / Grigio  
 leather  
**LED lighting** on shelves  
**DENNY** footstool, **RAKU** bench  
 (Please see COMPLEMENTI for these items)



comp. Store / 04



finiture / finishes  
Nobilitato Gurè / Gurè surfaced  
Laccato opaco Platino / Matt Platino lacquer



L238,4 P59,6 H277

→ IT

**Schienali** Nobilitato Gurè  
**Ripiani** Laccato opaco Platino  
**Cassettiere** Laccato opaco  
 Platino e **Maniglia T16**  
 verniciato Moka Shine  
**Raster** Laccato opaco Platino  
 con **scatole** rivestite in tessuto  
**Luci a led** su ripiani e **tubi**  
**appendiabiti** verniciato Moka  
 Shine

→ EN

**Back panels** Gurè surfaced  
**Shelves** Matt Platino lacquer  
**Drawer units** Matt Platino  
 lacquer and **T16 handle** painted  
 in Moka Shine  
**Cubby-hole unit** Matt Platino  
 lacquer with fabric-upholstered  
**boxes**  
**LED lighting** on shelves and  
**clothes rails** painted in Moka  
 Shine

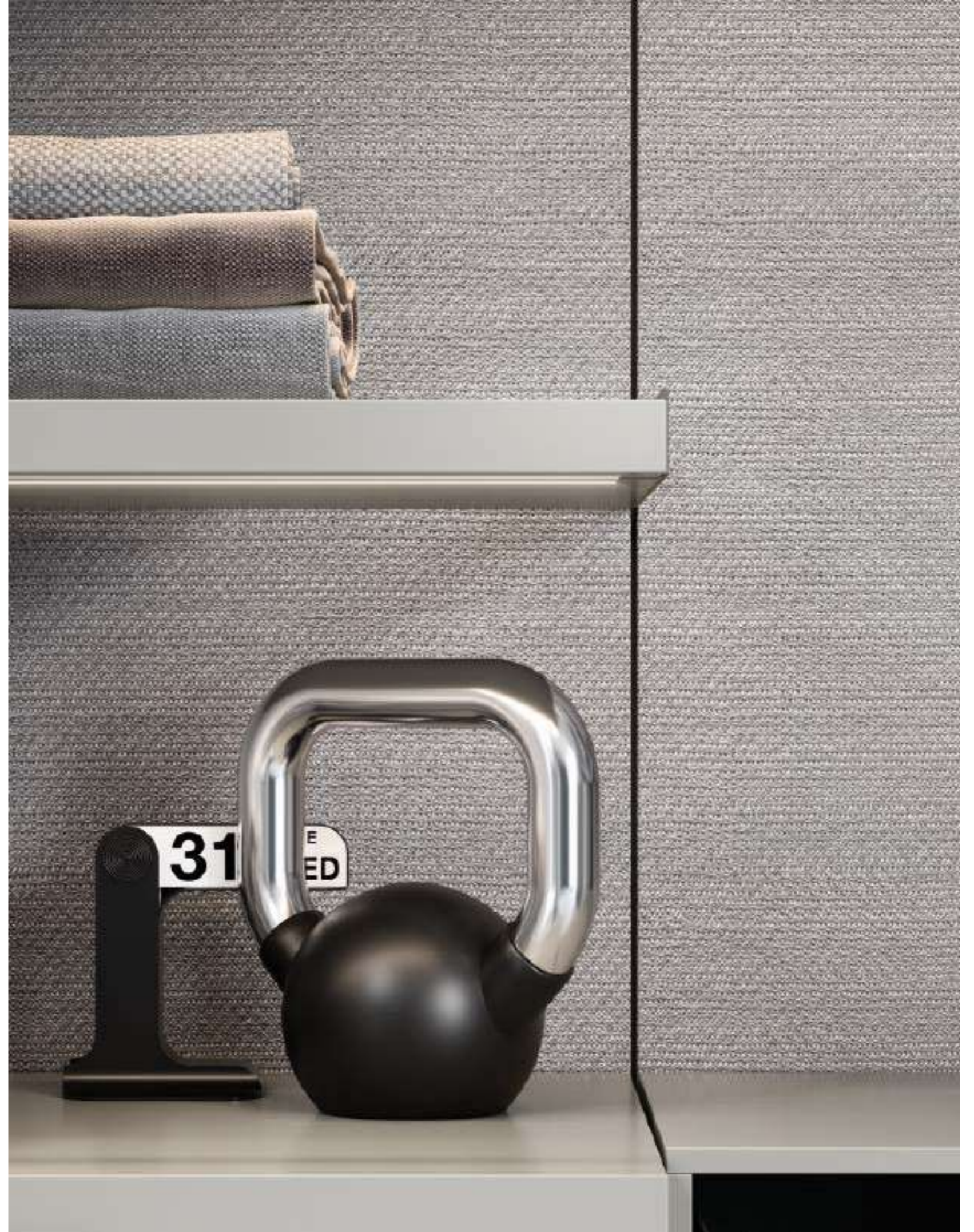

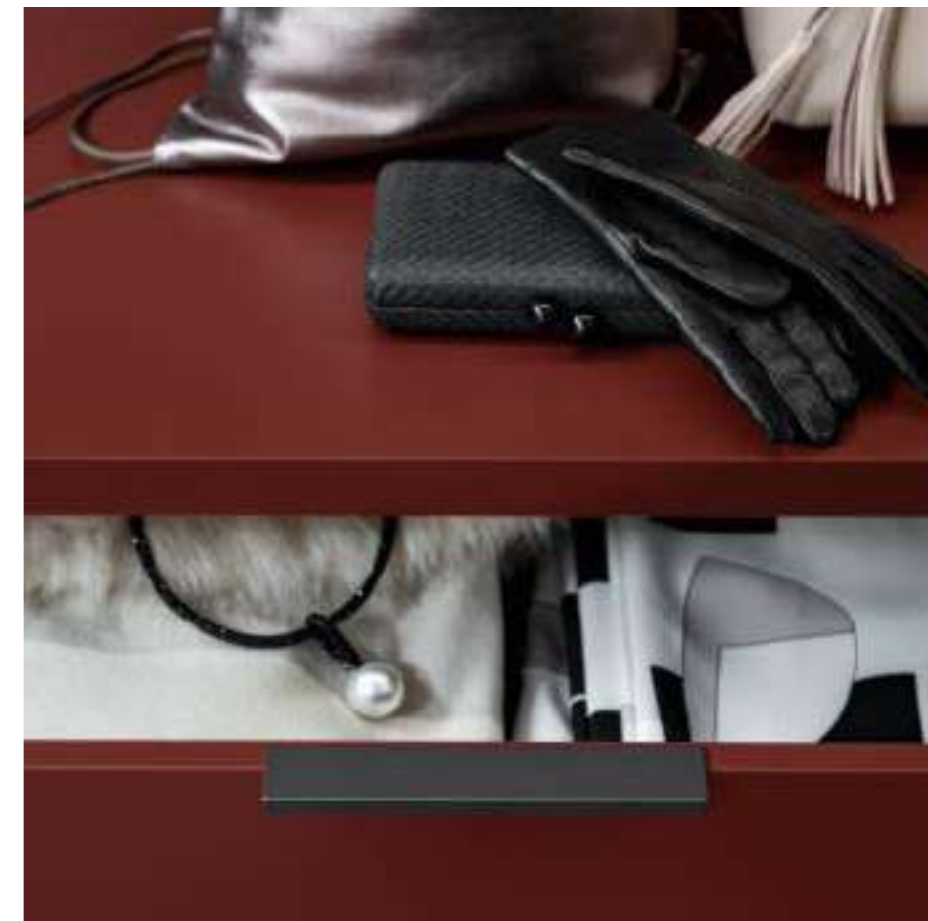

finiture / finishes  
Laccato opaco Modica / Matt Modica lacquer  
Laccato opaco Amaranto / Matt Amaranto lacquer









L278,4 X 509,6 P59,6 H270

→ IT

**Schienali** Laccato opaco Modica

**Ripiani** Laccato opaco Modica Amaranto e **Maniglia T16** verniciato Moka Shine

**Cassettiera portascarpe** Laccato opaco Modica e **Maniglia T16** verniciato Moka Shine

**Scrittoio** Laccato opaco Amaranto

**Pensili a giorno** Laccato opaco Modica

**Asta portasciarpa** verniciato Moka Shine

**Luci a led** su ripiani e **tubi appendiabiti** verniciato Moka Shine

**FIL** specchiera (per questo articolo vedi LETTI E GRUPPI NOTTE)

**DENNY** pouf (per questo articolo vedi COMPLEMENTI)

→ EN

**Back panels** Matt Modica lacquer

**Shelves** Matt Modica lacquer **Drawer units** Matt Amaranto lacquer and **T16 handle** painted in Moka Shine

**Shoe rack drawer unit** Matt Modica lacquer and **T16 handle** painted in Moka Shine

**Desk** Matt Amaranto lacquer **Open wall units** Matt Modica lacquer

**Scarf rail** painted in Moka Shine **LED lighting** on shelves and **clothes rails** painted in Moka Shine

**FIL** mirror (Please see BEDS AND STORAGE UNITS for this item)

**DENNY** footstool (Please see COMPLEMENTS for this item)

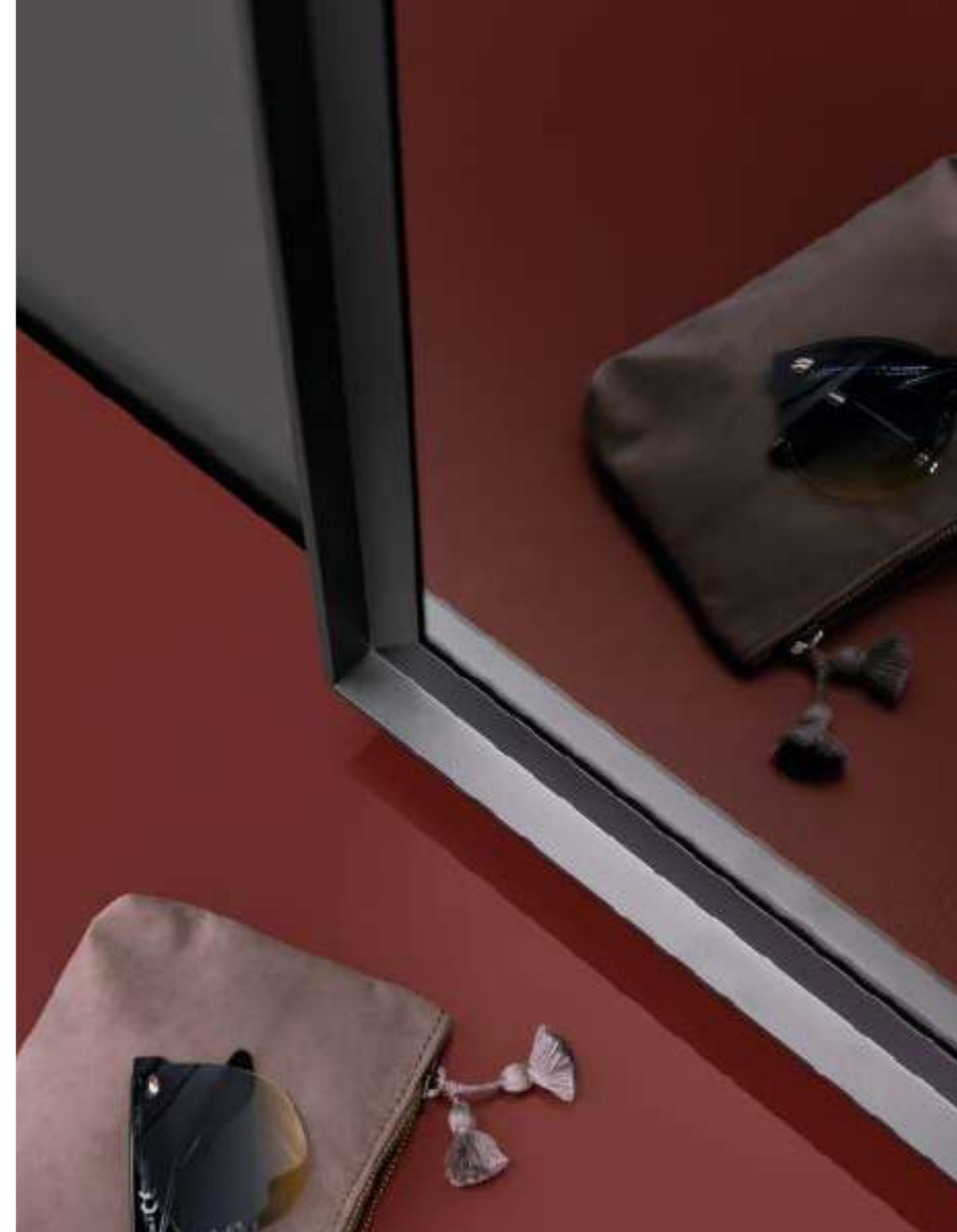



**ANTIS**  
è un sistema composto da "montanti"  
attrezzabili caratterizzato dalla libertà di  
scelta in altezza e di posizione degli elementi  
con la possibilità di creare molteplici  
configurazioni.

ANTIS is a system of "uprights" you can accessorise and build freely. You choose the height and position of the different elements to create infinite configurations.

ANTIS es un sistema formado por "montantes" equipables caracterizado por la posibilidad de elegir libremente la altura y la posición de los elementos, permitiendo crear diversas configuraciones.

ANTIS est un système composé de « montants » pouvant être équipés, caractérisé par la liberté de choix en hauteur et de position des éléments avec la possibilité de créer de multiples configurations.

ANTIS ist ein System, das aus ausstattbaren Montageleisten besteht. Es zeichnet sich besonders durch seine außergewöhnliche Flexibilität bei der Wahl der Höhe und der Position der Elemente sowie seine zahlreichen Kombinationsmöglichkeiten aus.

ANTIS - система из оснащаемых «стоек», характеризующаяся свободой выбора высоты и положения элементов с возможностью создания многочисленных конфигураций.

comp. Antis / 01



finitura / finish  
Fashion wood rovere Naturale / Naturale oak Fashion Wood



pag. 34  
comp. sx L236 P47,5 H247  
comp. dx L140 P38 H247

→ IT  
**Struttura** verniciato Moka Shine  
**Mensola** Fashion wood rovere Naturale  
**Mensola portascarpe** Fashion wood rovere Naturale / verniciato Moka Shine  
**Contenitore** Fashion wood rovere Naturale e Maniglia I verniciato Moka Shine  
**Contenitori Vas** Fashion wood rovere Naturale  
**Tubi appendiabiti** verniciato Moka Shine  
**RAKU** Panca  
(per questo articolo vedi COMPLEMENTI)

→ EN  
**Structure** painted in Moka Shine  
**Shelves** Naturale oak Fashion Wood  
**Shoe shelf** Naturale oak Fashion Wood / painted in Moka Shine  
**Storage unit** Naturale oak Fashion Wood and I handle painted in Moka Shine  
**Vas storage units** Naturale oak Fashion Wood  
**Clothes rails** painted in Moka Shine  
**RAKU** bench  
(Please see COMPLEMENTS for this item)

comp. Antis / 02



finitura / finish  
Fashion wood rovere Carbone / Carbone oak Fashion Wood



pag. 38/39  
 comp. sx L204 P47,5 H300  
 comp. centro L303 P45 H300  
 comp. dx L203,9 P45,1 H300

→ IT

**Struttura** verniciato Moka Shine  
**Mensole** Fashion wood rovere  
 Carbone

**Mensole portascarpe**  
 Fashion wood rovere Carbone /  
 verniciato Moka Shine

**Contenitori** Fashion wood  
 rovere Carbone e **Maniglia**  
**pomolo pelle** verniciato Moka  
 Shine / cuoio Grigio

**Contenitori VAS** Fashion wood  
 rovere Carbone

**Tubi appendiabiti** verniciato  
 Moka Shine

**Isola cassette STORE** Fashion  
 wood rovere Carbone / vetro  
 trasparente grigio e **Maniglia**  
**T16** verniciato Moka Shine

**RAKU** Poltroncina  
 (per questo articolo vedi  
 COMPLEMENTI)

→ EN

**Structure** painted in Moka Shine  
**Shelves** Carbone oak Fashion  
 Wood

**Shoe shelves** Carbone oak  
 Fashion Wood / painted in Moka  
 Shine

**Storage units** Carbone oak  
 Fashion Wood and **leather knob**  
**handle** painted in Moka Shine /  
 Grigio leather

**Vas STORAGE UNITS** Carbone  
 oak Fashion Wood

**Clothes rails** painted in Moka  
 Shine

**STORE island unit with drawers**  
 Carbone oak Fashion Wood /  
 Grigio transparent glass and **T16**  
**handle** painted in Moka Shine

**RAKU** armchair  
 (Please see COMPLEMENTS for  
 this item)





finitura / finish  
Laccato opaco Nude / Matt Nude lacquer

L466 P47,5 H255

→ IT

**Struttura** verniciato Moka Shine  
**Mensole** Laccato opaco Nude  
**Contenitori** Laccato opaco Nude  
**Contenitori VAS** Laccato opaco  
Nude con cassetti Cuoio 1031  
e **Maniglia M** verniciato Moka  
Shine  
**Tubi appendiabiti** verniciato  
Moka Shine  
**MALMO** tavolino, **RAKU**  
poltroncina  
(per questi articoli vedi  
COMPLEMENTI)

→ EN

**Structure** painted in Moka Shine  
**Shelves** Matt Nude lacquer  
**Storage units** Matt Nude lacquer  
**VAS storage units** Matt Nude  
lacquer with 1031 leather drawers  
and **M handle** painted in Moka  
Shine  
**Clothes rails** painted in Moka  
Shine  
**MALMO** occasional table,  
**RAKU** armchair  
(Please see COMPLEMENTS  
for these items)



44



comp. 03

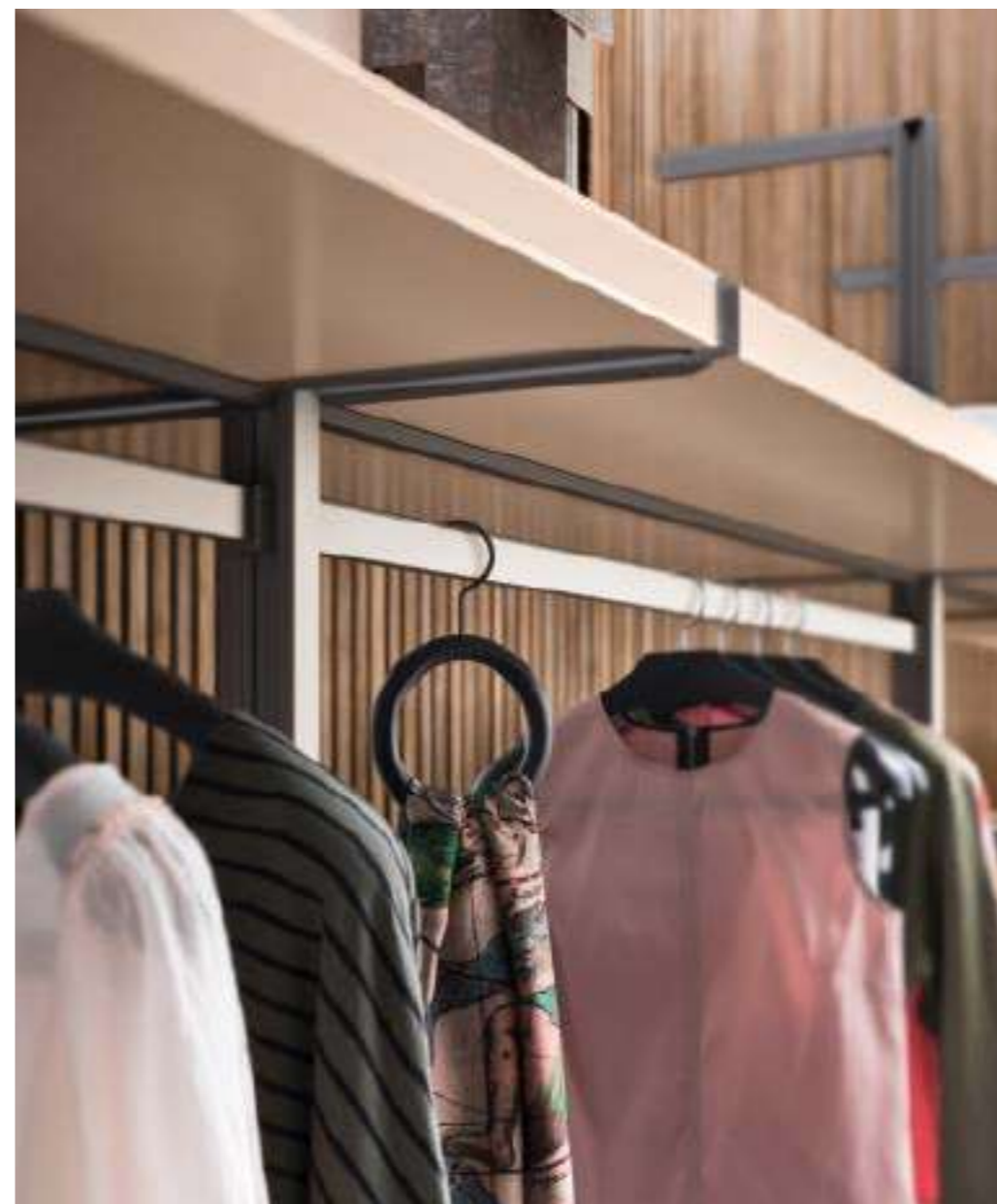

ANTIS

Alf DaFrè

45





L136,8 P45 H200

→ IT  
**Struttura** verniciato Moka Shine  
**Mensole** Laccato opaco Tè verde  
**Tubi appendiabiti** verniciato Moka Shine  
**RAKU** panca (per questo articolo vedi COMPLEMENTI)

→ EN  
**Structure** painted in Moka Shine  
**Shelves** Matt Tè Verde lacquer  
**Clothes rails** painted in Moka Shine  
**RAKU** bench (please see COMPLEMENTS for this item)





L204 P63,5 H232

→ **IT**  
**Struttura** verniciato Moka Shine  
**Mensole** Laccato opaco Tortora  
**Scrittoio** Laccato opaco Tortora  
**Contentore** Laccato opaco Tortora e **Maniglia T16** verniciato Moka Shine  
**Tubi appendiabiti** verniciato Moka Shine  
**ESAGONA** specchiera (per questo articolo vedi NEWS 2019)  
**RAKU** poltroncina (per questo articolo vedi COMPLEMENTI)

→ **EN**  
**Structure** painted in Moka Shine  
**Shelves** Matt Tortora lacquer  
**Desk** Matt Tortora lacquer  
**Storage units** Matt Tortora lacquer and **T16 handle** painted in Moka Shine  
**Clothes rails** painted in Moka Shine  
**ESAGONA** mirror (Please see NEWS 2019 for this item)  
**RAKU** armchair (Please see COMPLEMENTS for this item)



## Caratteristiche tecniche STORE / STORE technical characteristics



## Profilo cremagliera STORE / STORE rack profile

→ **IT**  
La cabina STORE è dotata di un pratico sistema di fissaggio a cremagliera che permette di riposizionare i vari elementi.

→ **EN**  
The STORE walk-in wardrobe has a practical rack fixing mechanism, so the different elements can be repositioned.



## Caratteristiche tecniche cabina STORE / STORE walk-in wardrobe technical characteristics

→ IT

La cabina può essere completata con: schienali, ripiani, panca, scrittoio, tubo appendiabiti, cassettiere, raster, pensili a giorno, accessori e barra led.

→ EN

The walk-in wardrobe can be finished with: back panels, shelves, a bench, a desk, clothes rails, drawer units, cubby-hole units, open wall units, accessories and LED lighting.

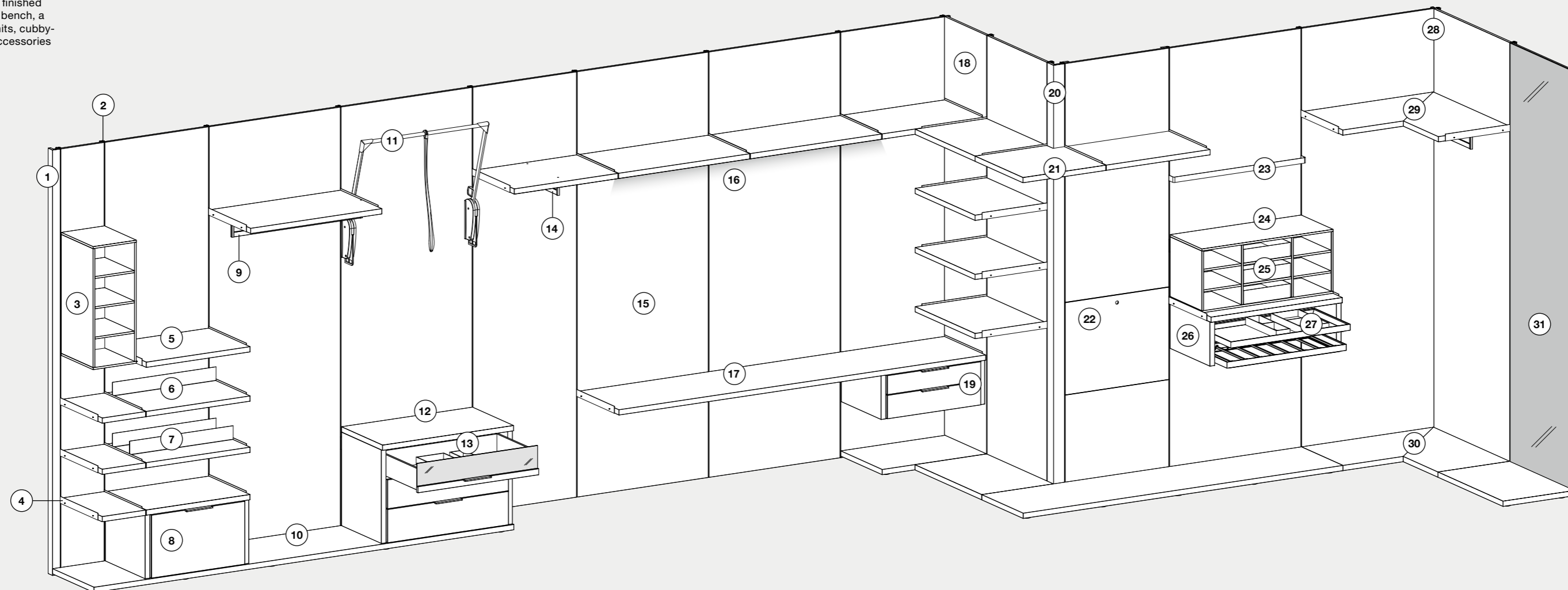

**1 / Fascia di tamponamento terminale Sp. 1,8 cm**  
End filler strip 1.8 cm thick

**2 / Profilo cremagliera in alluminio**  
Aluminium rack profile

**3 / Pensili a giorno**  
Open wall units

**4 / Staffa Sp. 0,3 cm in metallo**  
Metal bracket 0.3 cm thick

**5 / Ripiano Sp. 3,5 cm**  
Shelf 3.5 cm thick

**6 / Ripiano Sp. 3,5 cm con 1 portascarpe**  
Shelf 3.5 cm thick with 1 shoe rack

**7 / Ripiano Sp. 3,5 cm con 2 portascarpe**  
Shelf 3.5 cm thick with 2 shoe racks

**8 / Cassetiera con cesto portascarpe con frontale legno e staffe in metallo**  
Drawer unit with large shoe storage drawer with wooden front and metal brackets

**9 / Tubo appendiabiti con sviluppo in larghezza**  
Widthways clothes rail

**10 / Panca Sp. 3,5 cm**  
Bench 3.5 cm thick

**11 / Servetto oleodinamico**  
Hydraulic pull-down rack

**12 / Cassetiera con frontale vetro trasparente grigio/legno e staffe in metallo**  
Drawer unit with Grigio transparent glass/wooden front and metal brackets

**13 / Scatole portaoggetti rivestite in tessuto per cassetto**  
Fabric-upholstered storage boxes for drawers

**14 / Tubo appendiabiti con sviluppo in profondità**  
Depthways clothes rail

**15 / Schienale Sp. 1,8 cm**  
Back panel 1.8 cm thick

**16 / Barra led per ripiani**  
LED strip light for shelves

**17 / Scrittoio Sp. 3,5 cm**  
Desk 3.5 cm thick

**18 / Schienale angolo L Sp. 1,8 cm**  
L-shaped corner back panel 1.8 cm thick

**19 / Cassetiera con frontale legno e staffe in metallo**  
Drawer unit with wooden front and metal brackets

**20 / Schienale angolo aperto Sp. 1,8 cm**  
Open corner back panel 1.8 cm thick

**21 / Ripiano Sp. 3,5 cm per angolo aperto**  
Shelf 3.5 cm thick for open corner

**22 / Schienale ispezionabile Sp. 1,8 cm**  
Peep back panel 1.8 cm thick

**23 / Asta portascarpe**  
Scarf rail

**24 / Raster**  
Cubby-hole unit

**25 / Scatole rivestite in tessuto per raster**  
Fabric-upholstered boxes for cubby-hole units

**26 / Cassetiera con 1 vassoio estraibile e 1 portapantaloni con telaio alluminio**  
Drawer unit with 1 pull-out tray and 1 pull-out trouser rack with aluminium frame

**27 / Scatole portaoggetti rivestite in tessuto per vassoio estraibile**  
Fabric-upholstered storage boxes for pull-out tray

**28 / Angolo fuorisquadra**  
Out-of-square corner

**29 / Ripiano fuorisquadra Sp. 3,5 cm**  
Out-of-square shelf 3.5 cm thick

**30 / Panca fuorisquadra Sp. 3,5 cm**  
Out-of-square bench 3.5 cm thick

**31 / Schienale con specchio Sp. 1,8 cm**  
Back panel with mirror 1.8 cm thick



1 / Pensile a giorno  
Open wall unit

2 / Panca  
Bench

3 / Tubo appendiabiti con  
sviluppo in profondità  
Depthways clothes rail

4 / Cassettera con cesto  
portascarpe  
Shoe rack drawer unit

5 / Raster con scatole  
rivestite in tessuto  
Cubby-hole unit with fabric-  
upholstered boxes

6 / Vassoio portapantaloni  
Trousers tray

7 / Cassettera  
Drawer unit

8 / Ripiano  
Shelf

9 / Servetto oleodinamico  
Hydraulic pull-down rack

10 / FIL specchiera (per questo  
articolo vedi Letti e gruppi notte)  
FIL mirror (please see BEDS AND  
STORAGE UNITS for this item)

11 / Asta portascarpe  
Scarf rail

12 / Scrivania  
Desk

13 / Tubo appendiabiti con  
sviluppo in larghezza  
Widthways clothes rail

14 / Schienale con specchio  
Back panel with mirror

## Cassettiere e vassoi estraibili / Pull-out drawer units and trays

→ **IT**

Il programma STORE dispone di cassettiere con frontali legno vetro o a giorno e di vassoi estraibili in alluminio.

→ **EN**

The STORE collection features drawer units with wooden, glass or open fronts and pull-out aluminium trays.

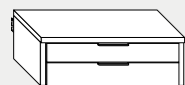

**Cassettiera con cassetti con frontale legno**  
Drawer unit with wooden-fronted drawers



**Cassettiera con cassetti con frontale vetro trasparente grigio/legno**  
Drawer unit with Grigio transparent glass/wooden-fronted drawers

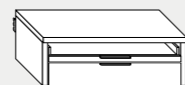

**Cassettiera con cassetti con frontale a giorno/legno**  
Drawer unit with open/wooden-fronted drawers

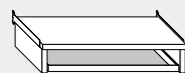

**Cassettiera con vassoi estraibili con telaio alluminio finitura grigio fumo H. 5 cm**  
Drawer unit with pull-out trays with aluminium frame in Grigio Fumo finish H. 5 cm



**Cassettiera con vassoi estraibili con telaio alluminio finitura grigio fumo H. 11 cm**  
Drawer unit with pull-out trays with aluminium frame in Grigio Fumo finish H. 11 cm



## Accessori per cassetti e vassoi / Accessories for drawers and trays

Scatole portaoggetti H. 5 cm rivestite in tessuto  
Fabric-upholstered storage boxes H. 5 cm



Scatole portaoggetti P. 44,7 cm rivestite in tessuto per cassetto  
Storage boxes D. 44.7 cm upholstered in fabric for drawers



Scatole portaoggetti P. 38,5 cm rivestite in tessuto per vassoio estraibile  
Storage boxes D. 38.5 cm upholstered in fabric for pull-out tray



## Proposte accessori per cassetti e vassoi / Examples of accessories for drawers and trays

Esempi di posizionamento scatola portaoggetti per CASSETTO  
Examples of how to position the storage compartments in a drawer

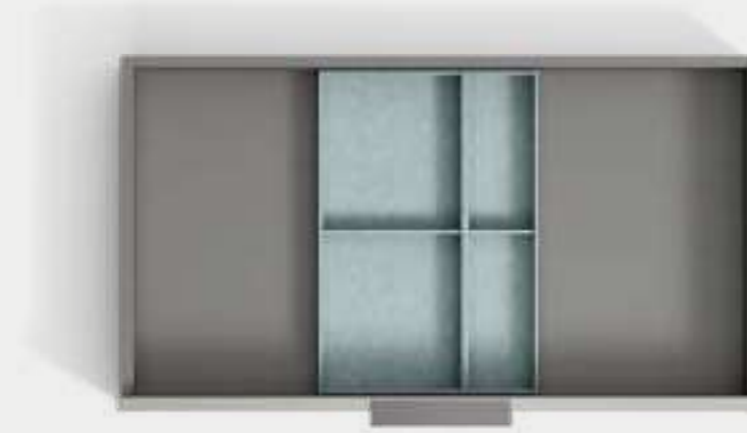

Esempi di posizionamento scatola portaoggetti per VASSOIO ESTRAIBILE  
Examples of how to position the storage compartments on a pull-out tray

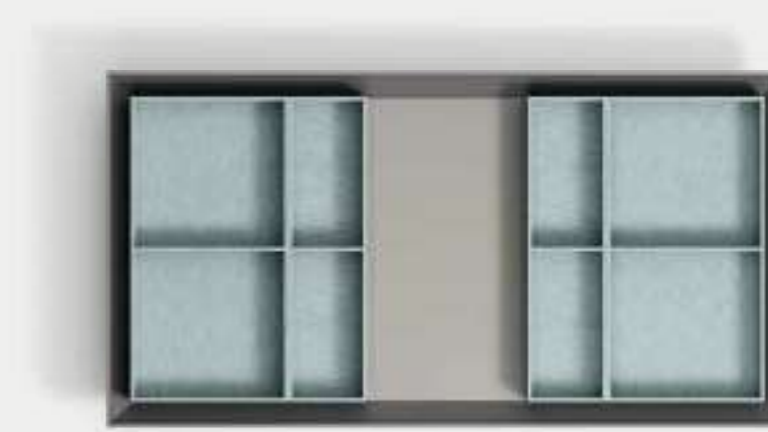

## Portapantaloni e portagonne estraibili / Pull-out trouser and skirt racks

→ **IT**  
Disponibili pratici portapantaloni e portagonne estraibili in alluminio.

→ **EN**  
Practical, pull-out aluminium trouser and skirt racks are also available.



**Portapantaloni estraibile con telaio alluminio finitura grigio fumo H. 5 cm**  
Pull-out trouser rack with aluminium frame in Grigio Fumo finish H. 5 cm



**Portagonne estraibile con telaio alluminio finitura grigio fumo H. 5 cm**  
Pull-out skirt rack with aluminium frame in Grigio Fumo finish H. 5 cm



## Soluzioni portascarpe / Shoe-rack solutions

→ **IT**  
STORE offre diverse soluzioni portascarpe come il cestone o i ripiani attrezzati con divisori in metallo.

→ **EN**  
STORE offers various shoe storage solutions such as the XL drawer or shelves with metal dividers.

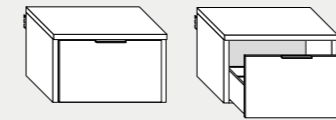

**Cassettiera con cesto portascarpe**  
Drawer unit with large shoe storage drawer

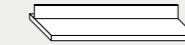

**Ripiano con portascarpe**  
Shelf with shoe rack



## Raster e pensili a giorno / Cubby-hole unit and open wall units

→ **IT**  
Ogni oggetto trova la sua perfetta collocazione tramite raster attrezzabili anche con scatole in tessuto e pensili a giorno.

→ **EN**  
There's room for all your possessions in the cubby-hole units that can also be equipped with fabric boxes, and open wall units.

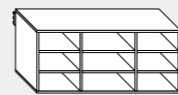

**Raster**  
Cubby-hole unit



**Scatole rivestite in tessuto per raster**  
Fabric-upholstered boxes for cubby-hole units



**Pensile a giorno**  
Open wall units

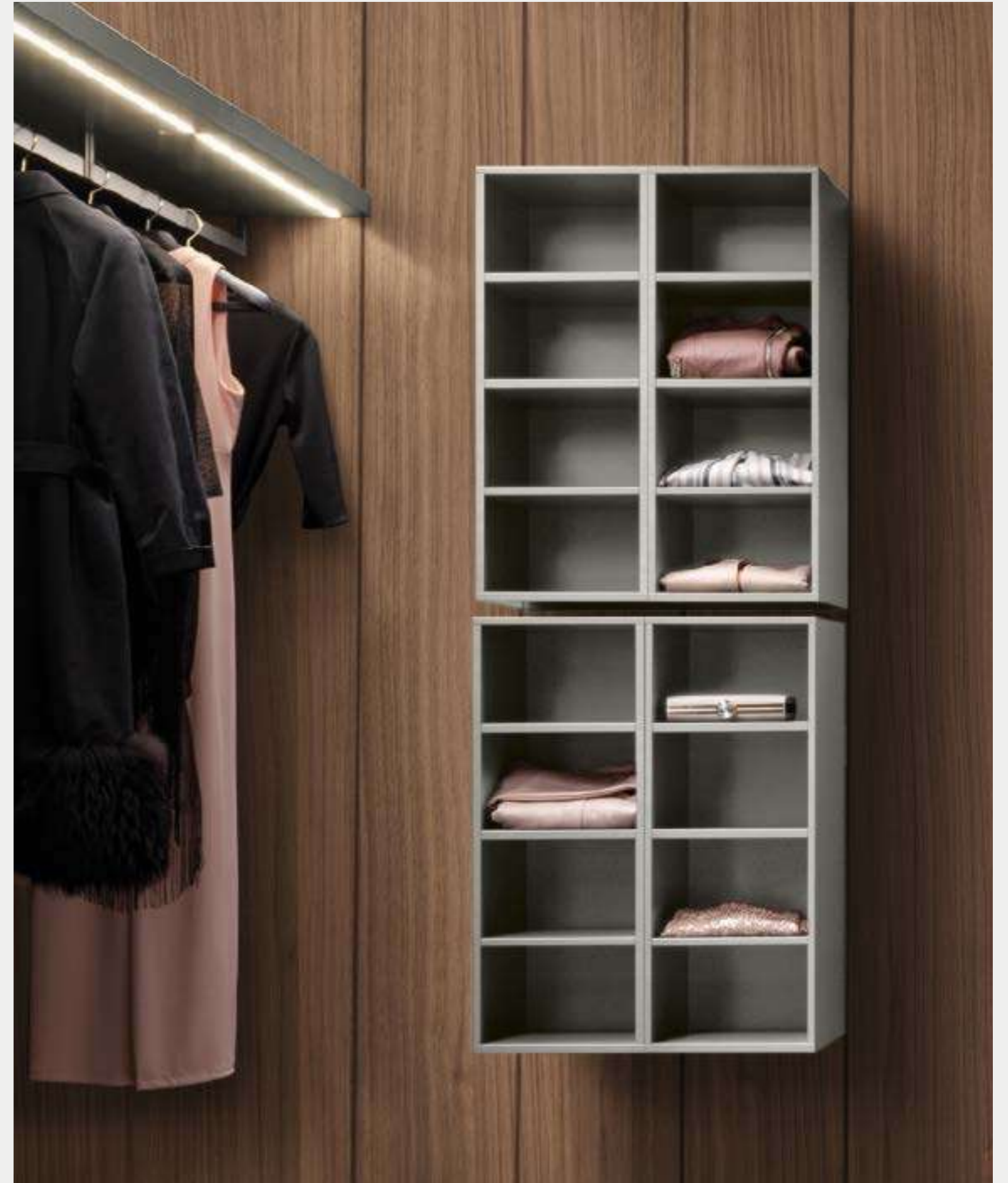



## Scrivania / Desk

→ **IT**  
 La cabina diventa vanity o home office con il pratico scrivania, anche con cassettiere.

→ **EN**  
 The walk-in wardrobe area can also serve as a dressing table or home office space with a practical desk, and additional drawer unit.

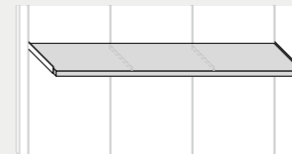

**Scrivania**  
 Desk

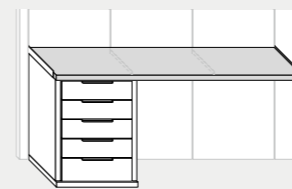

**Scrivania con cassettiere**  
 Desk with drawer unit

## Illuminazione / Lighting

→ **IT**  
L'illuminazione della cabina è affidata a barre a led perfettamente integrate nel design dei ripiani.

→ **EN**  
LED lighting is perfectly integrated into the shelf design to brighten the space.

**Barra led per ripiani**  
LED strip light for shelves



## Appenderia / Hanging rails

→ **IT**  
I tubi appendiabiti in metallo possono essere posizionati in senso longitudinale o trasversale.

→ **EN**  
The metal clothes rails can be installed lengthways or depthways.

**Tubo appendiabiti con sviluppo in larghezza**  
Widthways clothes rail



**Tubo appendiabiti con sviluppo in profondità**  
Depthways clothes rail

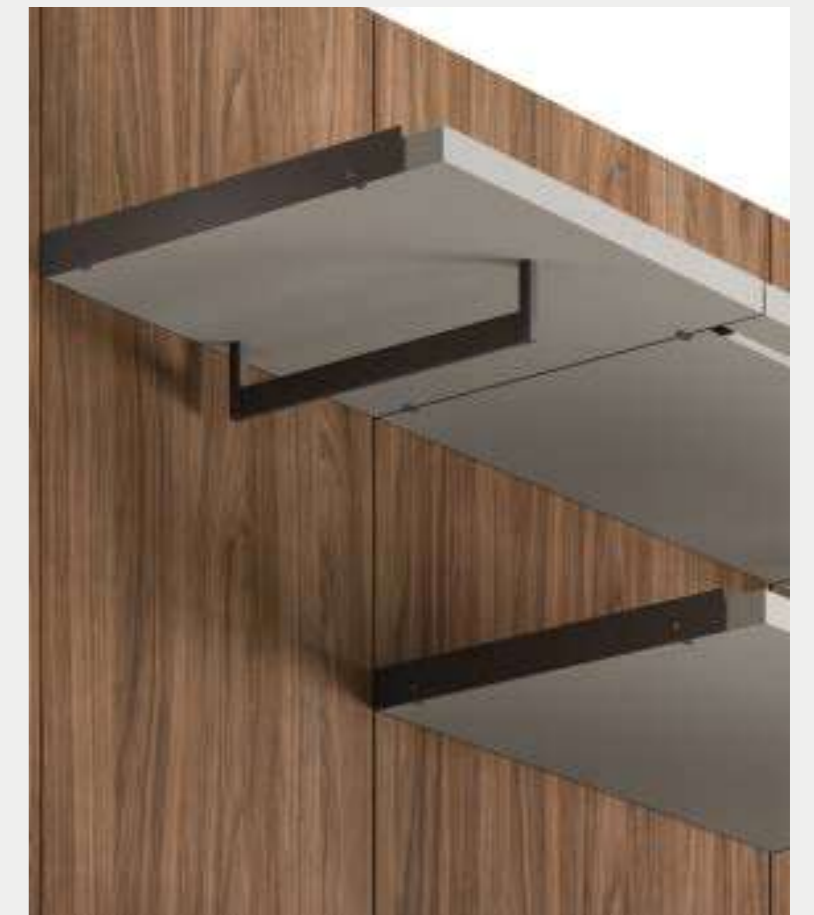

## Appenderia / Hanging rails

→ **IT**  
Gruccie con portapantaloni, portasciarpe e porta abiti, molteplici soluzioni per ogni esigenza.

→ **EN**  
Hangers with a trouser bar, scarf rings and clothes racks: storage solutions for your every need.

**Anello portasciarpa**  
Scarf ring



**Gruccia con portapantaloni**  
Hanger with trouser bar



**Asta portasciarpe**  
Scarf rail



**Forcella appendiabiti**  
High-reach clothes hook



**Servetto oleodinamico**  
Hydraulic pull-down rack



## Schienali specchio / Mirrored back panels

→ **IT**  
Lo schienale cabina diventa specchio disponibile in anche in una elegante versione in finitura grigia.

→ **EN**  
The walk-in wardrobe back panels can be used as a mirror, also available in an elegant Grigio finish.

**Schienale con specchio**  
Back panel with mirror



**Schienale con specchio grigio**  
Back panel with Grigio mirror



## Isola cassetti esterna / External drawer-unit island

→ **IT**

Una vera e propria "isola" che completa la zona cabina  
Dotata di cassetti con frontale legno o vetro e pratiche zone a giorno.

→ **EN**

An "island" unit to complete the walk-in wardrobe area  
Fitted with drawers with a wooden or glass front and practical open-fronted compartments.



**Isola cassetti esterna con frontale legno e maniglia T16**  
Island unit with external drawers, wooden fronts and T16 handle



**Isola cassetti esterna con frontale legno e pomolo pelle**  
Island unit with external drawers, wooden fronts and leather knob



**Isola cassetti esterna con frontale vetro trasparente grigio/legno e maniglia T16**  
Island unit with external drawers, Grigio transparent glass/wooden fronts and T16 handle



**Retro a giorno**  
Open back

## Montante ANTIS / ANTIS upright

→ **IT**

Antis è dotato di montanti posizionabili a soffitto o a parete attrezzabili con contenitori, mensole e accessori. Nella configurazione con montanti a soffitto la composizione può essere bifacciale.

→ **EN**

Antis is equipped with uprights that can be positioned on the ceiling or mounted on the wall, with storage units, shelves and accessories. In the version with ceiling uprights, the composition can be double-sided.



**Montante a soffitto/bifacciale**  
Ceiling/double-sided upright



**Montante a parete**  
Wall upright



## Caratteristiche tecniche cabina ANTIS / ANTIS walk-in wardrobe technical characteristics

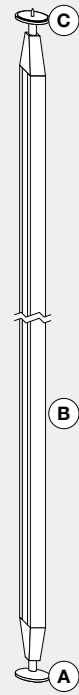

**Montante a soffitto / bifacciale**  
Ceiling/double-sided upright

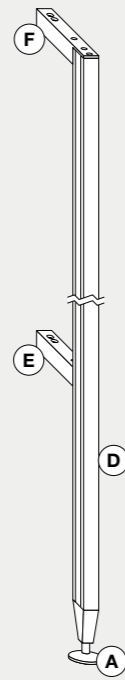

**Montante a parete**  
Wall upright

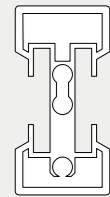

**Sezione montante a soffitto / bifacciale**  
Cross-section of ceiling/double-sided upright



**Sezione montante a parete**  
Wall upright cross-section

**A / Piede a terra Ø 5,7 cm (in appoggio a terra).**  
**N.B. permette la regolazione in altezza di 1 cm.**  
Foot Ø 5.7 cm (floor-standing).  
N.B. Adjust the unit height by 1 cm.

**B / Profilo per montante a soffitto in estruso di alluminio verniciato.**  
Coated extruded aluminium profile for ceiling upright.

**C / Piede a soffitto Ø 5,7 cm (fissato con vite al soffitto).**  
**N.B. permette la regolazione in altezza di 1 cm.**  
Ceiling support Ø 5.7 cm (screwed to the ceiling).  
N.B. Adjust the unit height by 1 cm.

**A / Piede a terra Ø 5,7 cm (in appoggio a terra).**  
**N.B. permette la regolazione in altezza di 1 cm.**  
Foot Ø 5.7 cm (floor-standing).  
N.B. Adjust the unit height by 1 cm.

**D / Profilo per montante a parete in estruso di alluminio verniciato.**  
Coated extruded aluminium profile for wall upright.

**E / Traverso centrale in estruso di alluminio verniciato (sempre presente a prescindere dall'altezza).**  
Coated extruded aluminium central crosspiece (always required, regardless of height).

**F / Traverso superiore in estruso di alluminio verniciato.**  
Coated extruded aluminium top crosspiece.

## Esempio di composizione / Composition examples

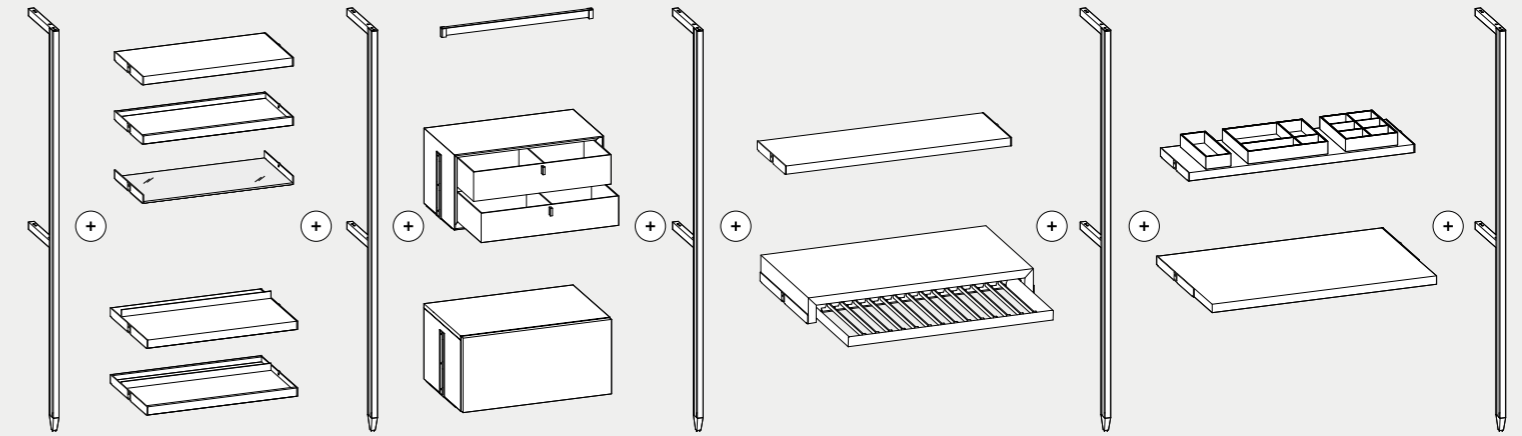

**Mensola legno sp. 3,5 cm con staffe in metallo**  
Wooden shelf 3.5 cm thick with metal brackets

**Mensola legno sp. 1,4 cm in folding con staffe in metallo**  
Folded wooden shelf 1.4 cm thick with metal brackets

**Mensola vetro trasparente grigio Sp. 0,8 cm con staffe in metallo**  
Grigio transparent glass shelf 0.8 cm thick with metal brackets

**Mensola legno Sp. 3,5 cm con portascarpe e staffe in metallo**  
Wooden shelf 3.5 cm thick with shoe rack and metal brackets

**Mensola legno Sp. 1,4 cm in folding con portascarpe e staffe in metallo**  
Folded wooden shelf 1.4 cm thick with shoe rack and metal brackets

**Tubo appendiabiti**  
Clothes rail

**Scatole rivestite in tessuto per mensole**  
Fabric-upholstered boxes for shelves

**Scrivania Sp. 3,5 cm con staffe in metallo**  
Desk 3.5 cm thick with metal brackets

**Portapantaloni estraibile con vassoio e staffe in metallo**  
Pull-out trouser racks with tray and metal brackets

**Contenitore VAS con staffe in metallo**  
VAS storage unit with metal brackets

**Box interno per contenitore VAS**  
Internal box for VAS storage unit

**Contenitore finito con staffe in metallo**  
Finished storage unit with metal brackets



**1 / Mensola vetro**  
Glass shelf

**2 / Contenitore con cassetti**  
Storage unit with drawers

**3 / Tubo appendiabiti**  
Clothes rail

**4 / Portapantaloni estraibile**  
Pull-out trouser rack

**5 / Mensola legno con portascarpe**  
Wooden shelf with shoe rack

**6 / Mensola legno**  
Wooden shelf

**7 / Contenitori VAS**  
VAS storage units

**8 / Contenitore con anta**  
Storage unit with door

**9 / Mensola legno in folding**  
Folded wooden shelf

**10 / Scatole in tessuto per mensole**  
Fabric boxes for shelves

**11 / Mensola legno in folding con portascarpe**  
Folded wooden shelf with shoe rack

## Mensole / Shelves

→ **IT**  
Il sistema Antis è attrezzabile con diverse tipologie di mensole in legno o vetro, vassoi o portascarpe.

→ **EN**  
The Antis range can be fitted with different types of wooden or glass shelves, trays and shoe racks.



**Mensola legno sp. 3,5 cm con staffe in metallo**  
Wooden shelf 3.5 cm thick with metal brackets



**Mensola legno sp. 1,4 cm in folding con staffe in metallo**  
Folded wooden shelf 1.4 cm thick with metal brackets



**Mensola vetro trasparente grigio Sp. 0,8 cm con staffe in metallo**  
Grigio transparent glass shelf 0.8 cm thick with metal brackets



**Mensola legno Sp. 3,5 cm con portascarpe e staffe in metallo**  
Wooden shelf 3.5 cm thick with shoe rack and metal brackets



**Mensola legno Sp. 1,4 cm in folding con portascarpe e staffe in metallo**  
Folded wooden shelf 1.4 cm thick with shoe rack and metal brackets



## Portapantaloni / Trouser rack

→ **IT**  
Disponibile anche un portapantaloni estraibile in alluminio.

→ **EN**  
A pull-out aluminium trouser rack is also available.



## Contenitori / Storage units

→ **IT**  
Con ante a ribalta o vasistas,  
a giorno o con pratici cassetti,  
tante le soluzioni disponibili.

→ **EN**  
With flap or tilt doors, with open  
fronts or practical drawers:  
there are many solutions to  
choose from.



## Accessori per mensole / Accessories for shelves

Scatole portaoggetti H. 5 cm rivestite in tessuto  
Fabric-upholstered storage boxes H. 5 cm

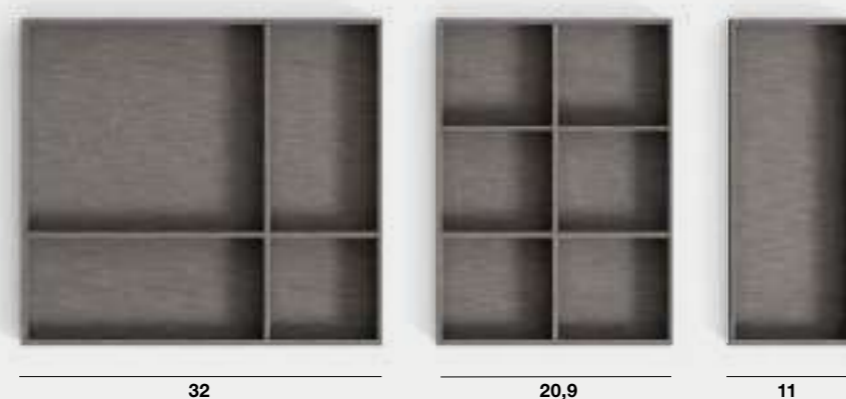

32

20,9

11

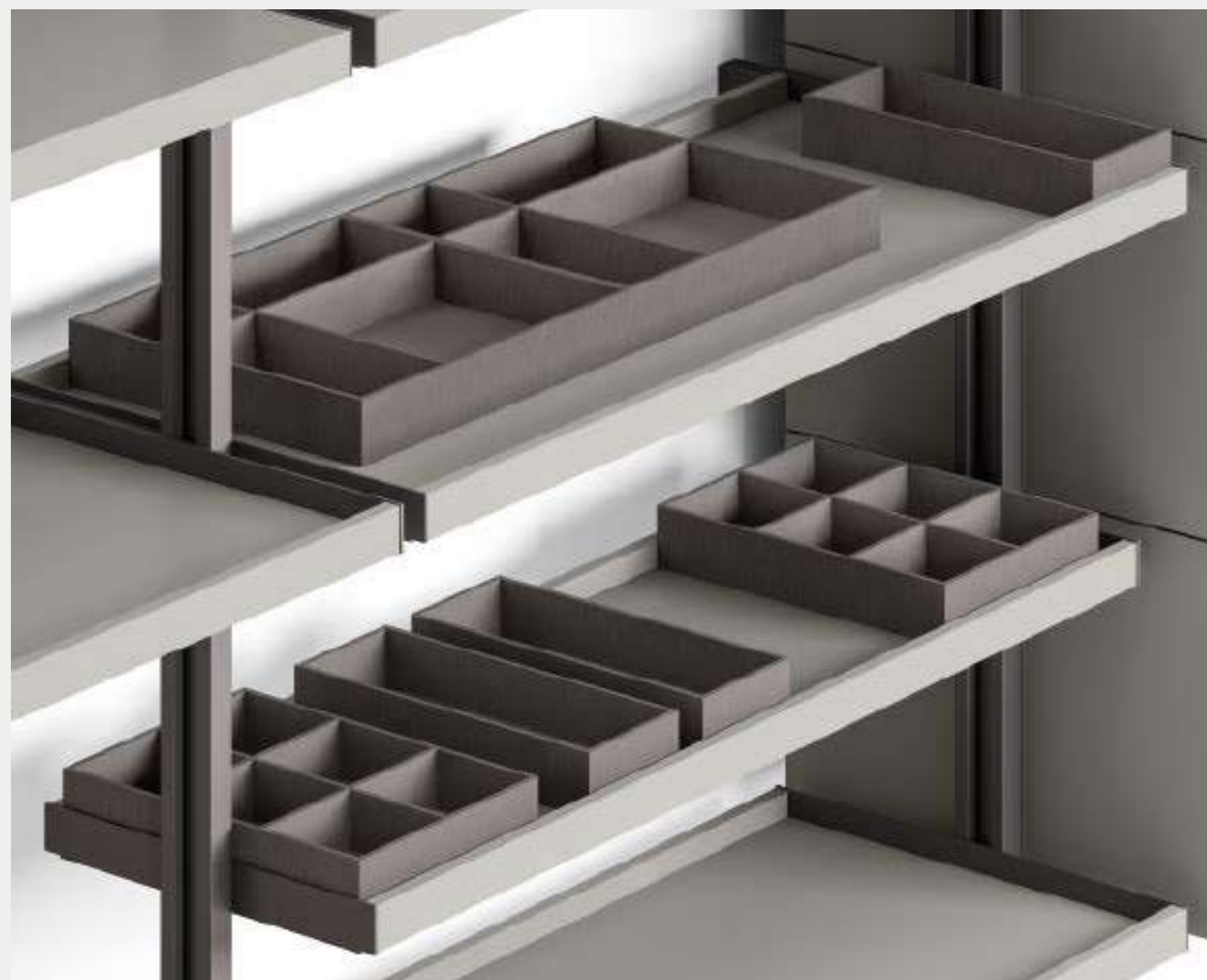

## Proposte accessori per mensole / Accessories for shelves

Esempi di posizionamento su mensole P. 32 cm  
Examples of how to position on shelves D. 32 cm



Esempi di posizionamento su mensole P. 41,6 cm  
Examples of how to position on shelves D. 41.6 cm



Esempi di posizionamento su mensole P. 50 cm  
Examples of how to position on shelves D. 50 cm



## Appenderia / Hanging rails

→ **IT**  
Gruccie con portapantaloni e portasciarpe completano la dotazione.

→ **EN**  
Hangers with a trouser bar and scarf rings complete the look.

**Gruccia con portapantaloni**  
Hanger with trouser bar



**Anello portasciarpa**  
Scarf ring

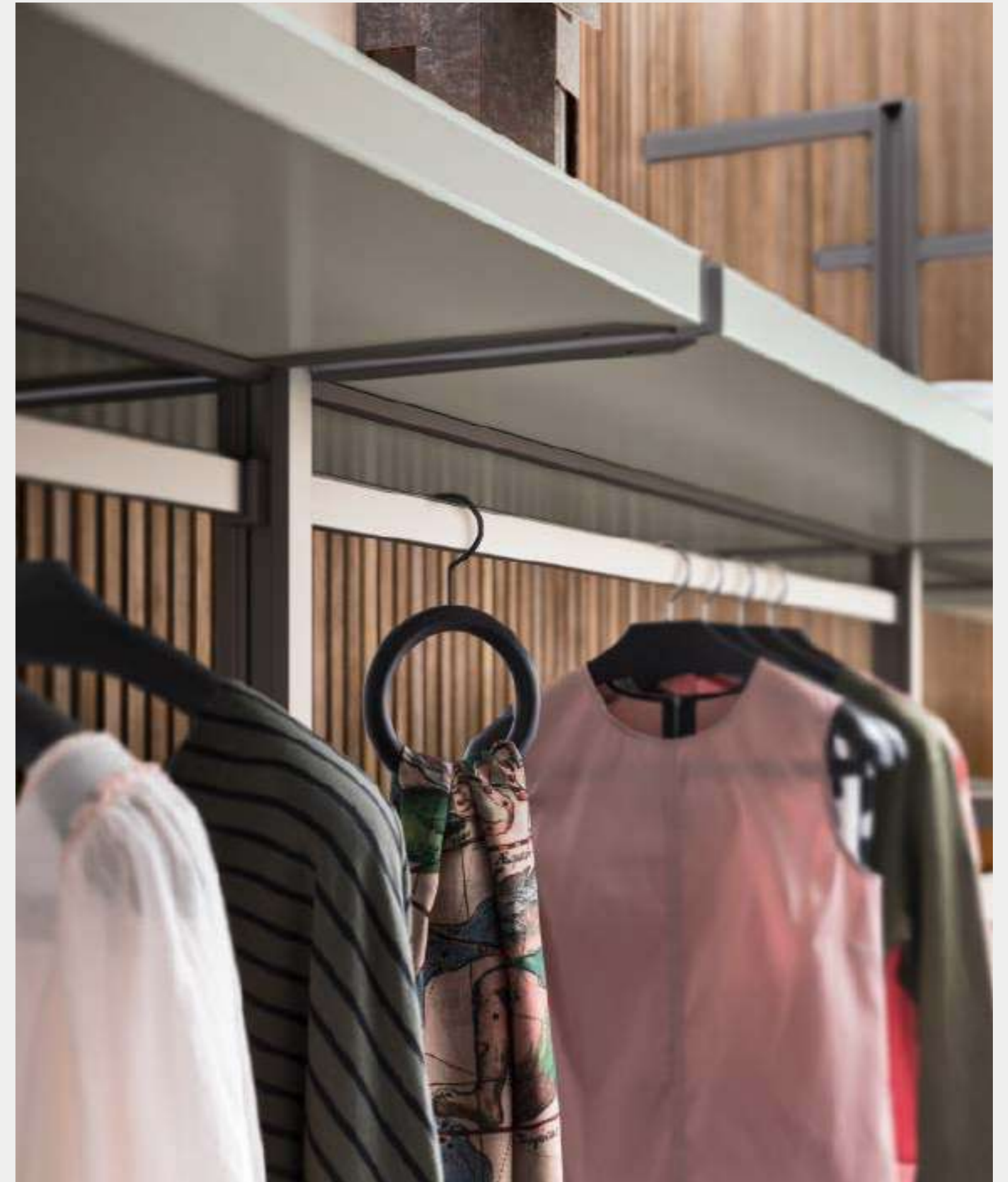

art direction  
**Bruna Vaccher**  
**Genny Canton**

graphic  
**Genny Canton Studio**

photo (p. 24 - 33)  
**Paolo Contratti**

styling (p. 24 - 33)  
**Rosanna Bignucolo**

digital image  
**Nudesign**

separations  
**Luce srl**

print  
**Sincromia**

stampato  
**Agosto 2021**



Verifica le finiture disponibili sul nostro sito internet. / Check the finishes available on our website. / Consulte los acabados disponibles en nuestro sitio web. / Vérifiez les finitions disponibles sur notre site internet. / Überprüfen Sie auf unserer Webseite, ob die gewünschte Ausführung erhältlich ist. / Познакомьтесь с вариантами отделки на нашем интернет-сайте **www.alfdafre.it**

**ALF UNO s.p.a.** si riserva di apportare in qualsiasi momento modifiche a prodotti, misure e materiali, che ritenesse utili per esigenze di carattere produttivo e commerciale. Per essere sempre aggiornati vi invitiamo a consultare il nostro sito internet **www.alfdafre.it**.

#### **LE FINITURE**

I materiali utilizzati dalla nostra azienda sono selezionati tra i più affidabili per applicazione e resa estetica. Nonostante questo devono considerarsi tollerabili alcune differenze dovute alle caratteristiche stesse di materiali come essenze naturali, vetri, laccature e all'artigianalità di alcune fasi del processo produttivo che da sempre è un nostro valore aggiunto. Inoltre alcune finiture possono subire nel tempo maturazioni dovute all'azione della luce e del tempo. È importante quindi specificare se nell'ordine vi sono sostituzioni o completamenti per valutare insieme il miglior modo di procedere. Le tonalità di colore e le finiture illustrate vanno considerate puramente indicative. Verificare sempre la fattibilità dell'abbinamento finiture consultando l'interno del listino.

**ALF UNO s.p.a.** reserves the right to make any changes to products, measurements and materials at any time deemed useful for manufacturing and sales purposes. To stay up to date at all times, please visit our website **www.alfdafre.it**

#### **FINISHES**

The materials we use are selected among the most reliable products in terms of application and aesthetic rendering. Despite this, certain differences due to the very characteristics of materials such as natural wood finishes, glass and lacquers must be considered tolerable, as well as the hand-crafted nature of certain phases of the production process, which has always been one of our added values. In addition, some finishes may change over time, due to the effects of light and time. It is therefore important to specify whether there are replacements or completions in the order to assess the best way to proceed together. The finishes featured in this sample collection are purely indicative and are not available for all products. Please check in the price list if the finish is available for the chosen item. Orders will not be accepted for products with finishes not included in the price list. The colour shades and finishes illustrated herein are to be considered purely indicative. Always check the feasibility of finish combinations by consulting the price list contents.

# world wide offices

**CANADA & USA NORTH-EAST COAST**  
TEL. (416) 663-2223 - FAX (416) 663-2594  
E-MAIL: alf@rosnerinternational.com

**CENTRAL AMERICA - CARIBBEAN ISLANDS**  
TEL. (787) 786-9705 - FAX (787) 785-9835  
E-MAIL: alvin@arodz.net

**LOUISIANA-OKLAHOMA-TEXAS**  
TEL. (405) 204-4737  
E-MAIL: parke@furnituresourcetexas.com

**ARIZONA-OREGON-WASHINGTON-NORTHERN CALIFORNIA-ALASKA-COLORADO-UTAH-NEW MEXICO-HAWAII**  
TEL. (707) 291 2995  
E-MAIL: corneliusssen@aol.com

**FLORIDA - ALABAMA**  
TEL. (321) 773-6982 - FAX (321) 773-8324  
E-MAIL: lloydavisiii@aol.com

**MID-WEST/SOUTH-EAST (EXCLUDING FLORIDA)**  
TEL. (310) 636-1199 - FAX (310) 636-4433  
E-MAIL: bill@weisbergsales.com

**U.S.A.: HIGH POINT SHOWROOM**  
(OPEN ONLY DURING FURNITURE MARKET DATES)  
TEL. (336) 889-9027

**NEVADA-SOUTHERN CALIFORNIA**  
E-MAIL: alf@alf.it

**AUSTRALIA & NEW ZEALAND**  
TEL. (08) 9314 3999 - FAX (08) 9314 3777  
E-MAIL: ross@merlino.com.au

**MEXICO**  
TEL. (55) 5351-1348  
E-MAIL: furnituzenteno@yahoo.com

**AUSTRIA**  
TEL. +43(0)4240 20358 - FAX +43(0)4240 20370  
E-MAIL: luca.zoldan@designphilosophy.org

**GERMANY**  
TEL. +49 171 8043908  
E-MAIL: roberto.sonego65@gmail.com

**SWITZERLAND**  
TEL. +39 342 776 0752  
E-MAIL: d.pagot@agentur2020.com

**DENMARK**  
TEL. +45 20475875  
E-MAIL: lehri@mail.dk

**BELGIUM - LUXEMBOURG**  
TEL. +32 471726845  
E-MAIL: jan@jmsa.be

**NETHERLANDS**  
TEL. +31-655-191753  
E-MAIL: arnold@hakse.com

**EAST EUROPE**  
TEL. +39 3484064921  
E-MAIL: caputomauro@libero.it

**ICELAND**  
TEL. +354 5880640  
E-MAIL: casa@casa.is

**U.K. - IRELAND**  
TEL. + 44 7980019194  
E-MAIL: design@atmosphere1102.com

**FRANCE - BRETAGNE - NORMANDIE - CENTRE**  
TEL. 0033608423974  
E-MAIL: contact@jmcsarl.fr

**FRANCE - EST**  
TEL. 0033615436985  
E-MAIL: ch.vidrin@wanadoo.fr

**FRANCE - SUD-EST**  
TEL. 06 33 83 87 58  
E-MAIL: fd.developpement@orange.fr

**FRANCE - ILE DE FRANCE - NORD**  
TEL. 06 60 65 61 62  
E-MAIL: decaix.christophe@wanadoo.fr

**FRANCE - SUD-OUEST**  
TEL. 06 40 55 21 88  
E-MAIL: tgirerd.gtb@gmail.com

**FRANCE - RHONE/ALPES**  
TEL. 0033689923725 - FAX 0033466777294  
E-MAIL: frederic.ac@orange.fr

**HELLAS-CYPRUS**  
TEL. +39 0434 77199 - FAX +39 0434 779591  
E-MAIL: luca.zoldan@designphilosophy.org

**INDIA-SRI LANKA**  
TEL. +91 8041285290 - 91 9845636644  
E-MAIL: keith@kreb.in

**ALF GROUP MIDDLE-EAST REP. OFFICE**  
TEL. +961 4718160 - FAX +961 4718159  
E-MAIL: info@alfme.com

**POLAND**  
TEL. +48 618175994 - FAX +48 616429218  
E-MAIL: karina@qualitaitaliana.pl

**CSI E PAESI BALTICI**  
TEL. +7-812-3322934 - FAX +7-812-3322934  
E-MAIL: office.spb@alf.it

**ALGERIA - TUNISIA**  
E-MAIL: info@wallitaliandesign.it

**SOUTH AFRICA**  
TEL. +27 0861777123 - FAX +27 0118262186  
E-MAIL: les@alfsa.co.za

**SPAIN - ANDALUCIA Y EXTREMADURA**  
TEL. +34 958818744 - FAX +34 935531590  
E-MAIL: info@javiercastellon.com

**SPAIN - CASTILLA Y LEON**  
TEL. +34983541003 - FAX +34983541003  
E-MAIL: evaristorg@gmail.com

**SPAIN - BARCELONA - CATALUNYA Y ANDORRA**  
TEL. +34 935531590 - FAX +34 935531590  
E-MAIL: albert-miro-mauri@hotmail.com

**SPAIN - VALENCIA, MURCIA Y CASTILLA LA MANCHA**  
TEL. +34 607 210 185  
E-MAIL: jlhervas.vlc@gmail.com

**SPAIN - MADRID**  
TEL. +34 607 363 016 - FAX +34 91 351 57 27  
E-MAIL: e.sesenna@telefonica.net

**SPAIN - SORIA, LA RIOJA, MALLORCA, MENORCA, IBIZA, FORMENTERA Y ASTURIAS**  
E-MAIL: alf@alf.it

**SPAIN - ARAGÒN**  
TEL. +34 650236594 - FAX +34 976598600  
E-MAIL: davidmirandamoreno@gmail.com

**SPAIN - PAIS VASCO, LA RIOJA, NAVARRA Y CANTABRIA**  
TEL. +34 656 703 204  
E-MAIL: iruoffice@iruoffice.com

**PORTUGAL**  
TEL. +351 919 723 837  
E-MAIL: alice.barroso@mail.telepac.pt

**TURKEY**  
E-MAIL: alf@alf.it

**INDONESIA - SINGAPORE**  
TEL. +65 91214415  
E-MAIL: alberto.fantin@soluzioni.com.sg

**TAIWAN - COREA DEL SUD - GIAPPONE**  
TEL. 0082 1086862707  
E-MAIL: mattiazanini.alfitalia@gmail.com

## Alf DaFre®

ALF UNO Spa  
Via S. Pio X 17  
31018 Francenigo di Gaiarine  
Treviso, Italy  
Tel. +39 0438 997111  
Fax Italia +39 0438 997245  
Fax estero +39 0438 997246  
www.alfdafre.it alf@alf.it



ALF UNO Spa  
è certificata **ISO 9001:2015**  
ALF UNO Spa  
is certified by the **ISO 9001:2015**

