

**CONTENITORI NOTTE
/ STORAGE UNITS**



Alf DaFre®

**CONTENITORI NOTTE
/ STORAGE UNITS**

Alf DaFre®

The Italian Home

Una casa dove sistemi, complementi e persone vivono in armonia. Questo è il pensiero chiave di ricerca e sviluppo del nuovo catalogo contenitori notte, in cui Alf DaFrè definisce un'estetica funzionale pensata per arredare con eleganza la zona notte. Comodini, comò e settimanali si distinguono per versatilità progettuale, equilibrio tra forme e materiali, e capacità di integrarsi in ambienti diversi con coerenza stilistica. L'integrazione tra finiture garantisce accostamenti cromatici coordinati con letti, armadi e sistemi, rafforzando l'identità compositiva di ogni spazio abitativo.

A home where systems, complements and people live in harmony. This is the key concept behind the research and development of the new night storage units catalogue, where Alf DaFrè defines a functional aesthetic designed to furnish the bedroom space with elegance. Bedside tables, dressers and tallboys stand out for their design versatility, balance of forms and materials, and ability to integrate seamlessly into different interiors with stylistic coherence. The integration of finishes ensures coordinated colour combinations with beds, wardrobes and systems, reinforcing the compositional identity of every living space.



Alf DaFrè: due nomi che narrano le vite di due giovani italiani cresciuti nel secondo dopoguerra. Alf è Oliviero, carismatico e solare, non ancora maggiorenne quando nel 1957 diventa socio della cooperativa Artigiana Legno Francenigo (Alf). Viaggiando prima per l'Italia e poi nel mondo, in 50 anni renderà Alf uno dei principali produttori di mobili in Italia. Da Frè è Rovilio, severo e ambizioso, appena ventunenne quando nel 1955 fonda il mobilificio DaFrè. Maniacco del dettaglio e amante del design, porterà DaFrè ad essere un marchio riconosciuto per qualità e design. Nel 2008 nasce Alf DaFrè: il talento imprenditoriale di Oliviero si unisce alla ricerca senza compromessi di Rovilio, il sapere industriale Alf si unisce all'anima sartoriale DaFrè per creare sistemi e complementi in armonia con gli ambienti e le persone che li vivono.



Due nomi, due volti



TWO NAMES, TWO FACES

Alf DaFrè: two names telling the stories of two young Italians growing up in the wake of the Second World War. Alf is Oliviero, cheerful and charismatic, and still just a teenager in 1957 when he became a member of the Artigiana Legno Francenigo (Alf) cooperative. Travelling first in Italy and then around the world, over 50 years he made Alf one of Italy's leading furniture producers. Da Frè is Rovilio, a serious and ambitious character, who founded the DaFrè furniture business in 1955, aged just 21. Obsessed with detail and passionate about design, he transformed DaFrè from unknown brand to symbol of quality and design.

In 2008 Alf DaFrè was born, as the entrepreneurial talent of Oliviero met the uncompromising innovation of Rovilio, and the industrial expertise of Alf met the sartorial spirit of DaFrè, creating interiors and furniture truly in harmony with their surroundings and the people who live in them.

Le persone

Maria Cristina Piovesana, Piero Piovesana e Flavio Da Frè guidano oggi Alf DaFrè, un'azienda nella quale la tradizione familiare ed i valori umani sono i veri patrimoni. In Alf DaFrè ogni mattina inizia con un buongiorno, a prescindere dagli attriti della sera precedente o dalle discussioni a venire. Una tradizione iniziata da Oliviero Piovesana e che prosegue tuttora, simbolo di un approccio affabile e gentile, per ricreare un senso di comunità che trascenda i rapporti professionali.

PEOPLE

Maria Cristina Piovesana, Piero Piovesana and Flavio Da Frè are now at the helm of Alf DaFrè, a company where family tradition and human values are considered the true assets. Every morning at Alf DaFrè must start with a "Good Morning", whatever quibbles there may have been the evening before or disagreements may be to come. This is a tradition introduced by Oliviero Piovesana that continues today; symbolic of a kind and pleasant approach, nurturing a sense of community that transcends professional relationships.

Il territorio

Alf DaFrè ha da oltre 70 anni sede nella provincia di Treviso, al confine tra Friuli e Veneto. Un territorio dove l'abbondante legno, trasportato via acqua e lavorato grazie alla forza motrice delle rogge, ha creato i presupposti per la nascita di una tradizione ebanista che prosegue oggi in Alf DaFrè. Un legame indissolubile con un territorio fatto da persone, scandito dall'alternarsi di Ville Venete, casali di campagna e centri abitati dai tratti veneziani. Un microcosmo di bellezza ed eleganza da cui Alf DaFrè trae continuamente ispirazione e che traspare in ogni suo prodotto e dettaglio.



THE LOCAL AREA

Alf DaFrè has been based in the province of Treviso (Italy), on the border between the Friuli and Veneto regions, for more than 70 years. Wood supplies are plentiful in this area, with the material being transported by water and worked thanks to the driving force of the man-made waterways, which has created the prerequisites for a cabinetmaking tradition that continues today at Alf DaFrè. There's an unbreakable bond between the company and the local area, made up of people, Palladian Veneto villas, country farmhouses, and residential areas with a Venetian flavour. It's a microcosm of beauty and elegance, from which Alf DaFrè draws continuous inspiration, and which permeates every product design and detail.



PRODUCTION

Over 150,000 square metres of production space, where artisan expertise and the combined efforts of a close-knit and highly motivated team come together to create unique interiors and furniture, made by people for people. Investment in people and innovative manufacturing technology. For over a decade, Alf DaFrè has implemented a policy of investment in 4.0 manufacturing systems, combining the productivity and flexibility of a modern company with the care and skilful touch of artisan expertise.

La produzione

Oltre 150.000 mq di spazi produttivi dove, dall'esperienza artigianale e dal lavoro di gruppo delle persone unite e motivate, nascono sistemi e complementi unici, fatti da persone per le persone. Investimenti nelle persone e nell'innovazione tecnologica produttiva. Da oltre un decennio Alf DaFrè promuove una politica d'investimento in impianti produttivi 4.0, coniugando produttività e flessibilità di un'azienda moderna con la cura e la mano invisibile del saper fare artigianale.

Sustainability

Impresa come valorizzazione del territorio



Alf DaFrè ha ampliato i suoi stabilimenti e continua il suo piano di sviluppo nel rispetto dell'ambiente, valutando i suoi impatti ambientali, realizzando un progetto sostenibile con la consapevolezza di essere attore in un sistema in cui capitale naturale e capitale umano devono essere preservati e valorizzati per le generazioni future e per l'intera comunità. Nei piani di sviluppo viene sempre messo in sicurezza idrogeologica il territorio in cui Alf DaFrè opera, proteggendolo dagli allagamenti e tutelando l'ecosistema locale.

A COMPANY WORKING WITH ITS SURROUNDINGS
Alf DaFrè has expanded its production sites and is moving forward with its development plan with respect for the environment, establishing a sustainable project, aware of its role in a system where natural capital and human capital must be safeguarded and promoted for future generations and the community as a whole. Development plans all include attention to the hydrogeological stability of the area in which Alf DaFrè operates, protecting it from flooding and preserving the local ecosystem.

La sostenibilità come un insieme di azioni che Alf DaFrè realizza attraverso una costante razionalizzazione dei processi e delle utenze, incrementando l'efficienza degli impianti che si traduce in un aumento della produttività a parità di consumo energetico. Oltre a controllare le emissioni in atmosfera, Alf DaFrè limita e riduce costantemente le esternalità attraverso azioni chiare e mirate. Vengono internalizzate le lavorazioni per ridurre il traffico su strada e si ottimizza la viabilità per l'accesso ai propri stabilimenti.

Sostenibilità come razionalizzazione



SUSTAINABILITY AS RATIONALISATION
Sustainability is managed as a set of actions implemented by Alf DaFrè through continuous rationalisation of processes and utilities, increasing the efficiency of systems, which translates into increased productivity with equal energy consumption. In addition to controlling atmospheric emissions, Alf DaFrè constantly limits and reduces outsourcing through clear and targeted measures. Processing is performed inhouse to reduce road transport and the road network leading to its sites has been optimised.

Alf DaFrè opera una costante ricerca per fornire materiali di altissima qualità, prediligendo l'uso di finiture all'acqua e materiali ecologici. I pannelli impiegati sono a bassa emissione di VOC e formaldeide secondo le normative EPA e CARB. Una qualità che mira a fornire prodotti che rispettino un principio cardine della sostenibilità, ovvero la durabilità nel tempo. L'attenzione verso i materiali è anche posta alla fase di raccolta differenziata, recupero e riutilizzo di questi, riciclandoli e ottimizzando gli imballaggi.



Costante ricerca nei materiali

CONSTANT RESEARCH INTO MATERIALS

Alf DaFrè carries out constant research in order to offer extremely high-quality materials, prioritising the use of water-based finishes and eco-friendly materials. The panels used have low VOC and formaldehyde emissions as per EPA and CARB regulations. The company strives for quality, enabling products aligned with a core principle of sustainability: durability. Focus is also placed on materials with a view to their separate processing on disposal, enabling their recovery and reuse, and the recycling and optimisation of packaging.

Benessere e valorizzazione delle persone



Per Alf DaFrè il benessere e la valorizzazione delle persone sono principi fondamentali verso il capitale umano. Per questo è stato stilato un Codice Etico che stabilisce i valori e i comportamenti sui quali si fondano le attività e i rapporti con dipendenti e collaboratori: per lavorare bene, in un mondo migliore.

WELLBEING AND PROMOTION OF HUMAN RESOURCES

At Alf DaFrè, ensuring the wellbeing of employees and promoting professional development are key principles in our approach to human capital. This is why a Code of Ethics has been established, setting out the values and conduct which forms the basis of the business and relationships with employees and partners: working well together, for a better world.

Index

Contenitori notte / Storage units



ADJ
pag. 120



BY SIDE
pag. 088



DA-DO SYSTEM
pag. 130



NOBU
pag. 114



OLIS
pag. 180



RAY
pag. 072



DEFILÉ
PAG. 046



FIL
pag. 148



GORGE
pag. 054



RIM
pag. 188



TIMELESS
pag. 194



TWICE
pag. 206



HOBBY
pag. 168



MEI
pag. 030



NADIR
pag. 014

Complementi / Complements

pag. 220

Nadir

Nadir è un gruppo notte composto da comò e comodino, disponibile anche con vano a giorno. La morbida curvatura dei fianchi e la fresata continuativa lo rendono ideale anche come elemento centrale nella zona notte, unendo versatilità ed eleganza.

Nadir is a bedroom set consisting of a dresser and a nightstand, also available with an open compartment. The soft curvature of the sides and continuous grooving make it ideal as a central element in the bedroom, combining versatility and elegance.

design R&D Alf DaFrè





Nadir gruppo notte / storage units
Laccato lucido Verde Foresta / High
gloss Verde Foresta lacquer
L/W45 P/D45 H46,8
L/W160 P/D55,4 H79,6

Rovi letto / bed
Fashion wood Rovere Naturale e Cuoio
Cognac / Natural oak Fashion wood and
Cognac leather
L/W174 P/D225,7 H97,5
→ Cat. Beds: Rovi p. 014

Disco specchiera / mirror
Moka shine
Ø96 P/D5,5



Nadir gruppo notte / storage units
Laccato lucido Verde Foresta e top in
Neolith Amazonico Decor Polished /
High gloss Verde Foresta lacquer and
Neolith Amazonico Decor Polished top
L/W45 P/D45 H46,8





022



Alf DaFrè



Nadir

Contenitori notte / Storage units

023



Nadir gruppo notte / storage units
Laccato opaco Mocha Mousse /
Matt Mocha Mousse lacquer
L/W45 P/D45 H46,8
L/W160 P/D55,4 H79,6

Levante letto / bed
Laccato opaco Mocha Mousse e
tessuto Made F21 / Matt Mocha
Mousse lacquer and Made F21 Fabric
L/W173,5 P/D214,5 H101
→ Cat. Beds: Levante p. 056

Disco specchiera / mirror
Moka shine
Ø96 P/D5,5



Nadir gruppo notte / storage units
 Laccato opaco Mocha Mousse e top
 laccato opaco Anfora / Matt Mocha
 Mousse lacquer and matt Anfora
 lacquer top
 L/W45 P/D45 H46,8





Nadir gruppo notte / storage units
Laccato opaco Platino / Matt Platino
lacquer
L/W45 P/D45 H46,8
L/W160 P/D55,4 H79,6

Rovi letto / bed
Fashion wood Rovere Terra e Tessuto
Taiga 01 90/3 / Terra oak Fashion wood
and Taiga 01 90/3 Fabric
L/W174 P/D225,7 H97,5
→ Cat. Beds: Rovi p. 014



NADIR

design R&D Alf DaFrè

Nadir è una collezione di contenitori notte dal design curvato, che comprende comodini e comò. Nella versione comodino, Nadir è proposto anche con vano a giorno. Come per il comò, può essere realizzato con il top in un colore a contrasto rispetto alla struttura. Sia nei comò che nei comodini è possibile inserire il top in ceramica, disponibile nelle finiture Alf DaFrè per la zona notte, per un effetto sofisticato e ricercato.

Materiali e finiture
 Struttura: laccato nella versione lucido, opaco o micalizzato.
 Interni: Skin effect Arena
 Piedi: Nickel, Moka Shine o in laccato in tinta con la struttura.

Nadir is a collection of bedroom storage units with a curved design, including nightstands and dressers. In the nightstand version, Nadir is also available with an open compartment. As with the dresser, it can be made with a top in a contrasting color to the structure. Both dressers and nightstands can be topped with ceramic surfaces, available in Alf DaFrè finishes for the bedroom, creating a sophisticated and refined effect.

Materials and finishes
 Structure: lacquered in high-gloss, matte, or mica-lacquered version.
 Interiors: Skin effect Arena.
 Feet: Nickel, Moka Shine, or lacquered in the same color as the structure.



Nadir gruppo notte / storage units
 Laccato opaco Bordeaux / Matt
 Bordeaux lacquer
 L/W160 P/D55,4 H79,6

Nadir gruppo notte / storage units
 Laccato opaco Bordeaux e top in Neolith Amazonico Decor Polished / Matt
 Bordeaux lacquer and Neolith Amazonico Decor Polished top
 L/W160 P/D55,4 H79,6

Gruppo letto / Bedroom suite

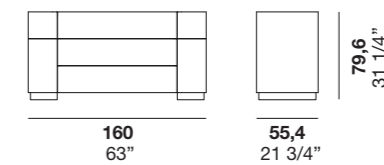
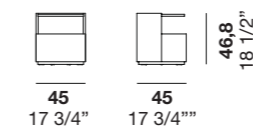
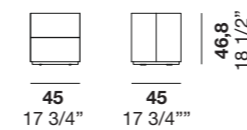

Mei

Mei è un gruppo notte composto da comodini e comò che si distingue per l'assenza dell'angolo tradizionale. Un design essenziale che valorizza la morbidezza delle forme e la raffinatezza dei materiali.

Mei is a bedroom set consisting of nightstands and dressers, distinguished by the absence of traditional corners. An essential design that highlights the softness of shapes and the refinement of materials.

design R&D Alf DaFrè





Mei gruppo notte / storage units
Laccato lucido Nude / High gloss
Nude lacquer
L/W60 P/D46 H46
L/W130 P/D54 H75

Paal letto / bed
Fashion wood Rovere terra e laccato
opaco Nude / Terra oak Fashion wood
and Matt Nude lacquer
L/W172,6 P/D221,8 H100,5
→ Cat. Beds: Paal p. 026





Mei gruppo notte / storage units
Laccato lucido-opaco Mocha
Mousse / High gloss-matt Mocha
Mousse lacquer
L/W130 P/D54 H75

Disco specchiera / mirror
Moka shine
Ø96 P/D5,5
Ø50 P/D5,5

Rim gruppo notte / storage units
Fashion wood Rovere Biscotto e laccato
opaco Anfora / Biscotto oak Fashion
wood and Anfora matt lacquer
L/W40 P/D40 H52

Sobi poltroncina / armchair
Tessuto Made F 19 / Made F 19 fabric
L/W87 P/D85 H71
→ **Cat. Sofas / Occasional Tables /
Armchairs**

Mei gruppo notte / storage units
Laccato micalizzato Nickel / Micalized
Nickel lacquer
L/W60 P/D46 H46

Milano 2 letto / bed
Tessuto Taiga 02/1 /
Taiga 02/1 fabric
L/W184 P/D234,8 H94,3
→ **Cat. Beds: Milano 2 p. 072**

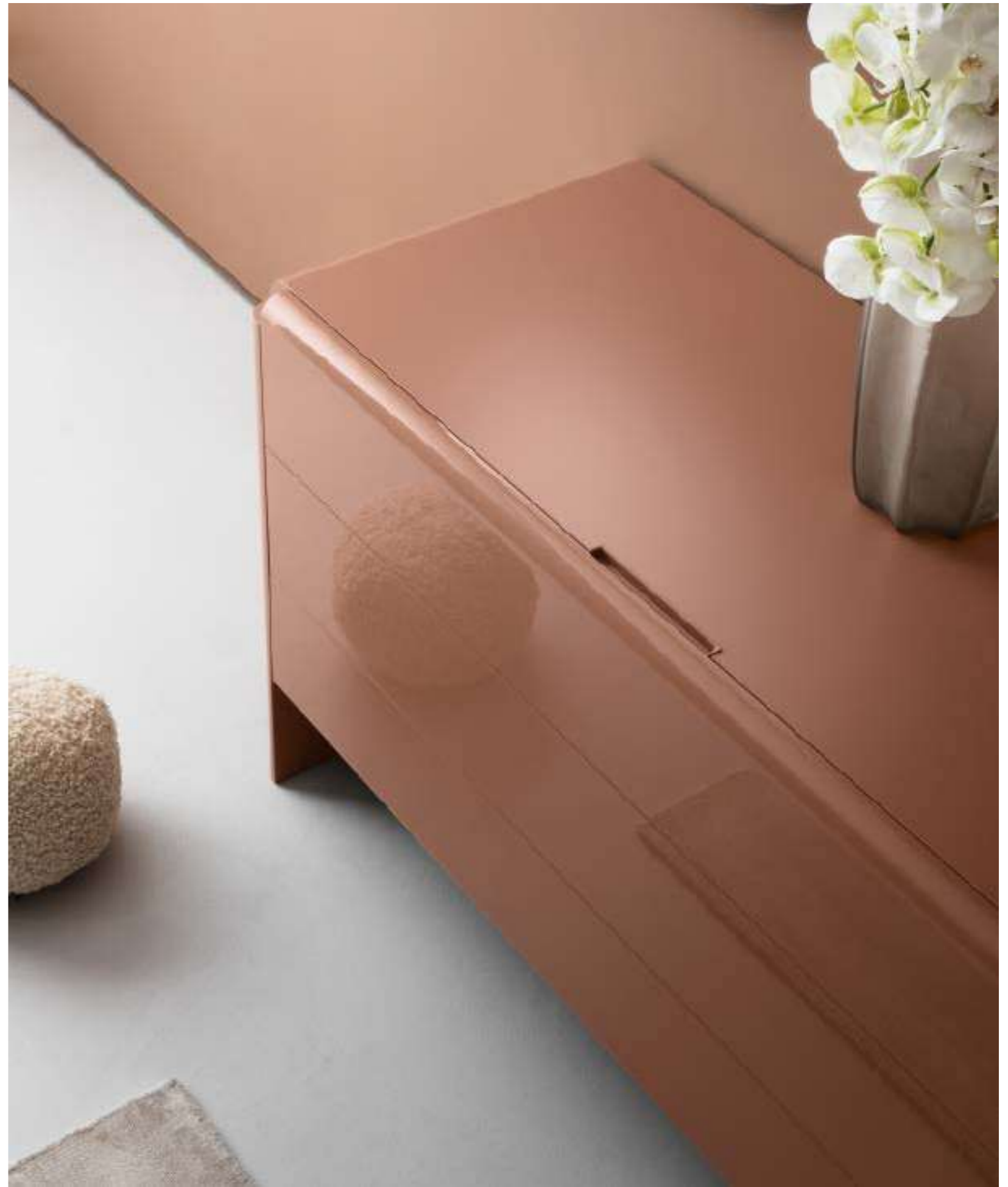



Mei gruppo notte / storage units
 Laccato lucido-opaco Mocha
 Mousse / High gloss-matt Mocha
 Mousse lacquer
 L/W130 P/D54 H75

Disco specchiera / mirror
 Moka shine
 Ø96 P/D5,5
 Ø50 P/D5,5

Rim gruppo notte / storage units
 Fashion wood Rovere Biscotto e laccato
 opaco Anfora / Biscotto oak Fashion
 wood and Anfora matt lacquer
 L/W40 P/D40 H52

Sobi poltroncina / armchair
 Tessuto Made F 19 / Made F 19 fabric
 L/W87 P/D85 H71
 → Cat. Sofas / Occasional Tables /
 Armchairs

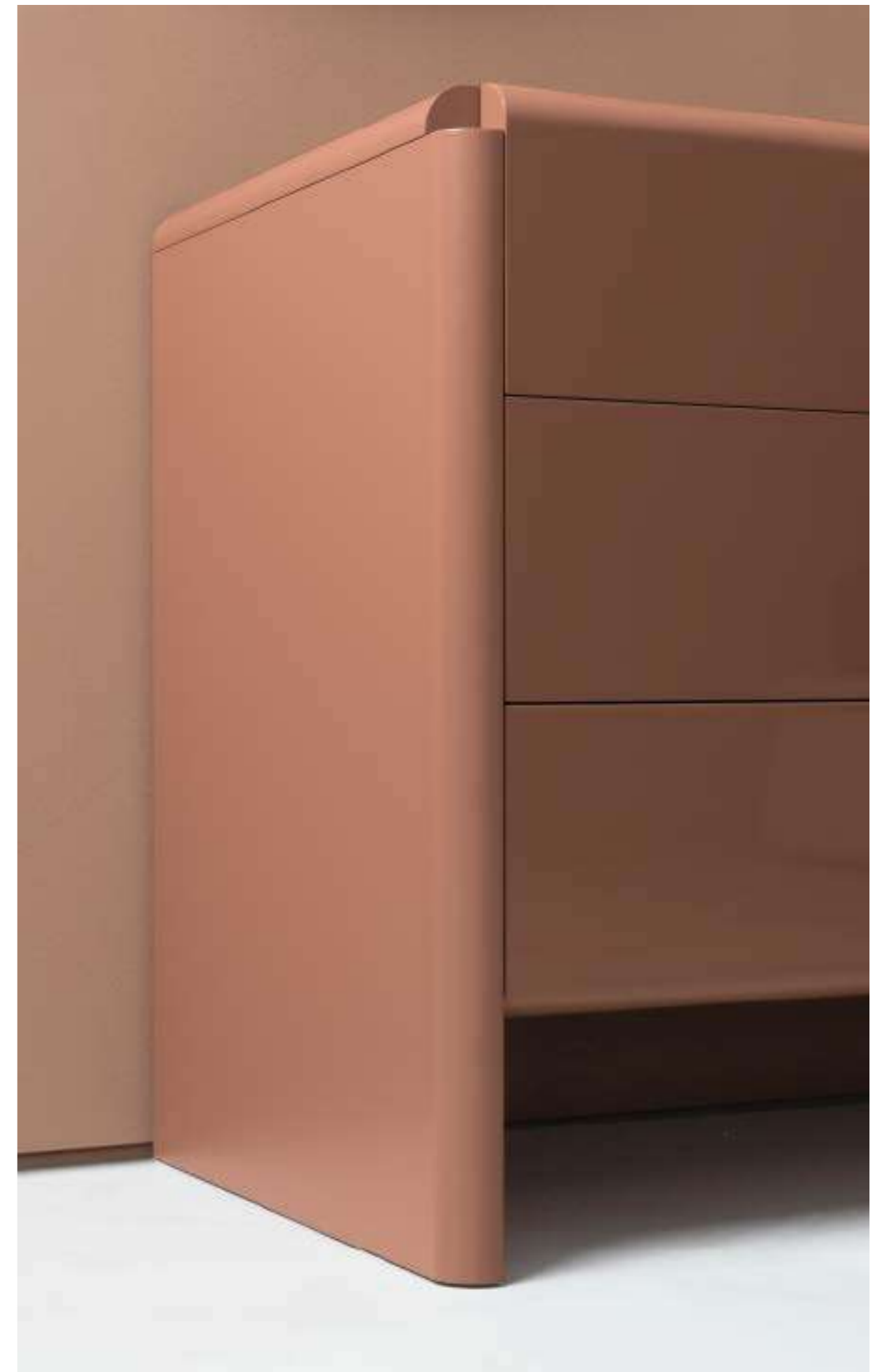



Mei gruppo notte / storage units
Laccato opaco Origano / Matt
Origano lacquer
L/W60 P/D46 H46

MEI

design R&D Alf DaFrè

Mei è un gruppo notte composto da comodino e comò, caratterizzato dai fianchi arrotondati e dall'assenza dell'angolo, elemento distintivo del design. È disponibile con possibilità di personalizzazione dei frontali lucidi e dei fianchi e top laccati opachi, per aggiungere un tocco di charme alla zona notte.

Materiali e finiture
Struttura: laccato nella versione lucido, opaco o micalizzato.
Interni: Skin effect Arena

Mei is a bedroom set consisting of a nightstand and dresser, characterized by rounded sides and the absence of corners, a distinctive design feature. It is available with customizable glossy fronts and matte lacquered sides and tops, adding a touch of charm to the bedroom.

Materials and finishes
Structure: lacquered in the high gloss, matte, or mica-lacquered version.
Interiors: Skin effect Arena.

Gruppo letto / Bedroom suite



Mei

Contenitori notte / Storage units

Defilè

Un sistema che integra boiserie, mensole e contenitori in un'unica composizione elegante. Defilè abbina il calore del legno Groove alla raffinatezza delle laccature opache e micalizzate, creando un fondale architettonico ricco di personalità. L'insieme diventa arredo e decorazione al tempo stesso, trasformando la parete in elemento protagonista della zona notte.

A system that integrates boiserie, shelves, and storage units into a single elegant composition. Defilè combines the warmth of Groove wood with the sophistication of matte and metallic lacquers, creating an architectural backdrop full of character. The ensemble becomes both furniture and decoration, transforming the wall into a focal point of the bedroom area.

design R&D Alf DaFrè





Defilè gruppo notte / Bedroom suite
Groove Noce naturale e laccato opaco
Moka Shine / Groove Naturale walnut and
matt Moka Shine lacquer
L/W377 P/D52,4 H91,2

Milano 2 letto / bed
Tessuto Nina 39 / Nina 39 fabric
L/W184 P/D234,8 H94,3
→ Cat. Beds: Milano 2 p. 072



Defilè gruppo notte / Bedroom suite
Groove Noce naturale e laccato opaco
Moka Shine / Groove Naturale walnut and
matt Moka Shine lacquer
L/W377 P/D52,4 H91,2

Milano 2 letto / bed
Tessuto Nina 39 / Nina 39 fabric
L/W184 P/D234,8 H94,3
→ Cat. Beds: Milano 2 p. 072



DEFILÈ

design R&D Alf DaFrè

Defilè è un gruppo letto caratterizzato da testierine in legno abbinata a mensole portaoggetti.

Materiali e finiture
 Pannello boiserie: Groove
 Contenitore: Nobilitati, Laccati opachi e lucidi, Laccati micalizzati.

Defilè is a bedroom suite with wooden headboards paired with storage shelves.

Materials and finishes
 Boiserie panels: Groove
 Storage unit: Surfaced, matt and high-gloss lacquers, micalised lacquer.

Gruppo letto / Bedroom suite

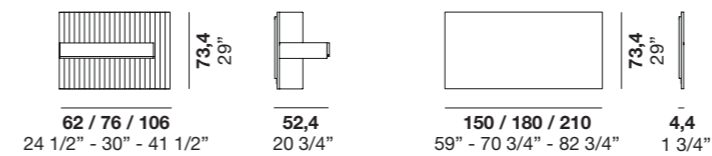

Gorge

Volumi puri, dettagli sofisticati e finiture a contrasto definiscono Gorge. I top in ceramica valorizzano la matericità delle superfici, mentre le gole luminose aggiungono un tocco raffinato. La collezione si articola in molteplici moduli, con o senza piedini, per un'eleganza estetica pulita e funzionale.

Pure volumes, sophisticated details, and contrasting finishes define Gorge. Ceramic tops enhance the materiality of the surfaces, while illuminated grooves add a refined touch. The collection is composed of multiple modules, with or without feet, offering a clean and functional aesthetic elegance.

design R&D Alf DaFrè





Gorge gruppo notte / storage unit
 Noce Naturale e Top Neolith Himalaya
 crystal ultra soft / Naturale walnut and
 Neolith Himalaya crystal ultra soft top
 L/W60 P/D45 H47,2



Gorge gruppo notte / storage unit
 Fashion wood rovere Terra e Top Laminam Sahara
 Noir extra lucidato / Terra oak Fashion Wood and
 Extra-glossy Laminam Sahara Noir top
 L/W60 P/D45 H47,2



Gorge gruppo notte / storage unit
 Noce Naturale e Top laccato opaco Fango
 / Naturale walnut and matt Fango lacquer
 top L/W145,8 P/D50 H74,4

Disco specchiera / mirror
 Verniciato Moka Shine / Moka Shine painted
 Ø96 P/D5,5



Gorge gruppo notte / storage units
Noce Naturale e Top laccato opaco Fango /
Naturale walnut and matt Fango lacquer top
L/W60 P/D45 H47,2
L/W145,8 P/D50 H74,4

Haiku servomuto / clothes stand
Struttura verniciato Moka Shine e ripiani
Fashion wood Rovere Fossile / Moka Shine
painted structure and Fossile oak Fashion
Wood shelves L/W45 P/D45 H47,2



Gorge gruppo notte / storage units
 Fashion wood rovere Terra e Top Laminam
 Sahara Noir extra lucidato / Terra oak
 Fashion Wood and Extra-glossy Laminam
 Sahara Noir top
 L/W120 P/D50 H74,4
 L/W60 P/D45,2 H47,2

Gorge

Raku panca / bench
 Tessuto Nina 18 e a destra tessuto Nina 39
 / Nina 18 fabric and on the right Nina 39
 fabric
 L/W150 P/D68 H53
 → Cat. Sofas / Occasional Tables /
 Armchairs

Contentori notte / Storage units

Disco specchio / mirror
 Verniciato Moka Shine / Moka Shine
 painted
 Ø76,5 P/D5,5



Gorge gruppo notte / storage units
Laccato opaco Tè verde / matt Tè Verde
lacquer
L/W45 P/D45 H47,2
L/W60 P/D50 H120





Gorge gruppo notte / storage units
Laccato opaco Tè verde / matt Tè Verde
lacquer
L/W60 P/D50 H120
L/W45 P/D45 H47,2

Moca tavolino / occasional table
Laccato opaco Tortora / matt Tortora
lacquer
Ø60 H45,4
→ Cat. Sofas / Occasional Tables /
Armchairs



Gorge gruppo notte / storage units
 Fashion wood rovere Terra e Top Laminam
 Sahara Noir extra lucidato / Terra oak
 Fashion Wood and Extra-glossy Laminam
 Sahara Noir top L/W120 P/D50 H82,7

Disco specchiera / mirror
 Verniciato Moka Shine / Moka Shine painted
 Ø76,5 P/D5,5

Neyō letto / bed
 Pelle Lord 9190 / Lord 9190 leather
 L/W315,5 P/D220,3 H98,5
 → Cat. Beds: Neyō p. 094



Gorge gruppo notte / storage units
Fashion wood rovere Terra e Top Laminam
Sahara Noir extra lucidato / Terra oak
Fashion Wood and Extra-glossy Laminam
Sahara Noir top
L/W60 P/D45 H55,5
L/W120 P/D50 H82,7

Disco specchiera / mirror
Verniciato Moka Shine / Moka Shine
painted
Ø76,5 P/D5,5

GORGE

design R&D Alf DaFrè

Gorge è un gruppo letto composto da comodini in tre larghezze, comò a 3 e 6 cassetti e settimanale in due larghezze. L'apertura avviene tramite gola sul top che può essere illuminata. Disponibile top Laminam Sahara Noir Extra Lucidato, Neolith Amazonico Decor Polished o Neolith Himalaya crystal ultrasoft. Disponibile anche con piedini in metallo.

Materiali e finiture
Struttura: Nobilitati, Fashion wood, Roveri laccati opachi, Laccati opachi, Laccati micalizzati.
Disponibile Top in ceramica, vedi scheda finiture.

Gorge is a bedroom suite made up of bedside tables in three widths, dresser with 3 and 6 drawers, and tall chest of drawers in two widths. They open using a groove in the top that can also feature lighting. Extra-glossy Laminam Sahara Noir / Neolith Amazonico Decor Polished or Neolith Himalaya Crystal Ultrasoft tops available. Also available with metal feet.

Materials and finishes
Frame: Surfaced, Fashion Wood, matt lacquered oak, matt lacquer, micalised lacquer.
Ceramic Top available, see the finishes sheet.

Gruppo letto / Bedroom suite

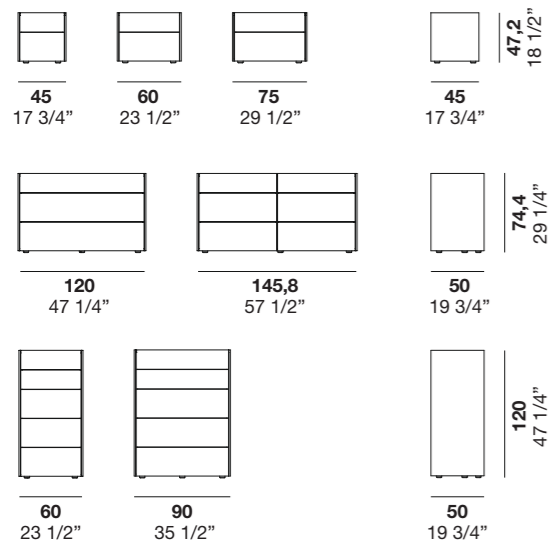

072



Alf DaFrè

Gruppo letto con piedi in metallo / Bedroom suite with metal feet

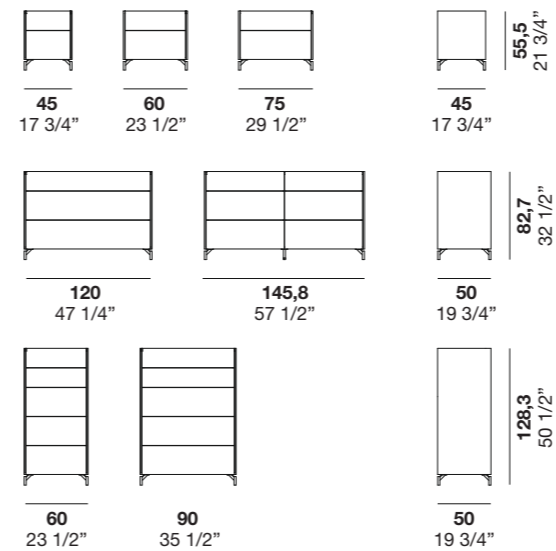

Gorge



Contenitori notte / Storage units

073

Ray

Linee morbide e arrotondate sui fianchi e frontali rendono Ray un sistema notte dall'anima accogliente. La possibilità di inserire vani a giorno e combinare finiture diverse, incluse ceramiche pregiate, offre grande libertà compositiva. Ray arreda con leggerezza, adattandosi perfettamente a spazi contemporanei dal gusto ricercato.

Soft, rounded lines on the sides and fronts give Ray a warm, inviting character. The option to include open compartments and combine different finishes, including fine ceramics, offers great compositional freedom. Ray furnishes with lightness, perfectly adapting to contemporary spaces with a refined taste.

design Enrico Cesana





Disco specchiera / mirror
 Verniciato Moka Shine / Moka Shine
 painted
 Ø76,5 P/D5,5

Ray gruppo notte / storage units
 Laccato opaco Juta e Top Laminam Sahara
 Noir extra lucidato / matt Juta lacquer and
 Extra-glossy Sahara Noir top

L/W60 P/D51,5 H74,3
 L/W45/60 P/D46,5 H46,2
 L/W133 P/D51,5 H74,3

Hug letto / bed
 Cuoio 1031 e Tessuto Antibes 802 / 1031
 Leather and Antibes 802 fabric
 L/W177 P/D226 H94
 → Cat. Beds: Hug p. 122



Ray gruppo notte / storage units
Laccato opaco Juta e Laminam Sahara
Noir extra lucidato / matt Juta lacquer and
Extra-glossy Sahara Noir top

L/W133 P/D51,5 H74,3
L/W60 P/D51,5 H119,1
L/W45 P/D46,5 H46,2

Disco specchiera / mirror
Verniciato Moka Shine / Moka Shine
painted
Ø96 P/D5,5



Ray gruppo notte / storage units
Laccato opaco Piombo / matt Piombo
lacquer

L/W133 P/D51,5 H74,3
L/W90 P/D51,5 H119,1
L/W60 P/D46,5 H46,2

Nobilitato Noce Naturale / Surfaced
Naturale walnut
L/W45 P/D46,5 H46,2

Ray gruppo notte / storage units
Laccato opaco Arena / matt Arena lacquer
L/W60 P/D46,5 H46,2
L/W90 P/D51,5 H119,1

Nobilitato Noce Naturale / Surfaced
Naturale walnut
L/W133 P/D51,5 H74,3

Laccato opaco Aghata / matt Aghata
lacquer
L/W45 P/D46,5 H46,2
L/W60 P/D51,5 H119,1

Laccato opaco Modica / matt Modica
lacquer
L/W60 P/D51,5 H119,1



Ray gruppo notte / storage units
Nobilitato Noce Naturale / Surfaced
Naturale walnut
L/W133 P/D51,5 H74,3



Ray gruppo notte / storage units
Nobilitato Noce Naturale / Surfaced
Naturale walnut
L/W60 P/D46,5 H46,2
L/W133 P/D51,5 H74,3

Denny pouf
Pelle Lord 9100 / Lord 9100 leather
Ø85 H37
→ Cat. Sofas / Occasional Tables /
Armchairs



Ray gruppo notte / storage units
Nobilitato Noce Naturale / Surfaced
Naturale walnut
L/W60 P/D46,5 H46,2

Laccato opaco Platino e Fashion wood
Rovere Carbone / Matt Platino lacquer and
Carbone oak Fashion Wood
L/W60 P/D46,5 H46,2

Laccato opaco Juta e Top Neolith
Amazonico decor polished / matt Juta
lacquer and Neolith Amazonico decor
polished top
L/W45 P/D46,5 H46,2



Ray gruppo notte / storage units
Laccato opaco Platino e Top Fashion wood
Rovere Carbone / matt Platino lacquer and
Carbone oak Fashion Wood top
L/W60 P/D46,5 H46,2
L/W90 P/D51,5 H119,1

Wok tavolino / occasional table
Laccato opaco Platino / matt Platino
lacquer
Ø27,5 H50
→ Cat. Sofas / Occasional Tables /
Armchairs

RAY

design Enrico Cesana

Ray è un gruppo letto composto da comodini in due larghezze, comò e settimanale in due larghezze. Caratterizzato dal design by stonato di fianchi e frontali è disponibile anche in versione con vano a giorno. Disponibile top Laminam Sahara Noir Extra Lucidato, Neolith Amazonico Decor Polished o Neolith Himalaya crystal ultrasoft e in versione frontali e scocca in finiture differenti.

Materiali e finiture
Struttura: Nobilitati, Noce, Fashion wood, Roveri laccati opachi, Laccati opachi, Laccati micallizzati.
Disponibile Top in ceramica, vedi scheda finiture.

Ray is a bedroom suite made up of bedside tables in two widths, dresser and tall chest of drawers in two widths. Featuring side panels and fronts with a rounded design, it also comes in a version with an open compartment. Extra-glossy Laminam Sahara Noir, Neolith Amazonico Decor Polished or Neolith Himalaya Crystal Ultrasoft tops available and in a version with fronts and carcasses in different finishes.

Materials and finishes
Frame: Surfaced, Walnut, Fashion Wood, matt lacquered oak, matt lacquer, micallised lacquer.
Ceramic Top available, see the finishes sheet.

Gruppo letto / Bedroom suite

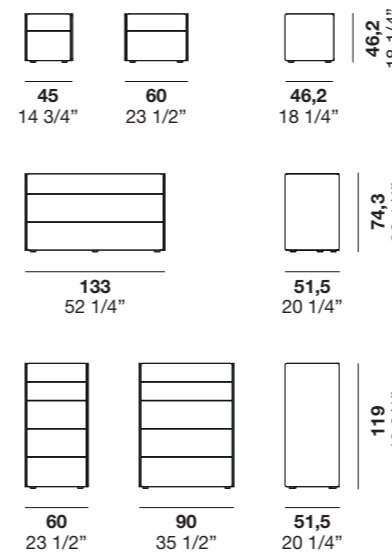

Gruppo letto con vano a giorno / Bedroom suite with an open compartment

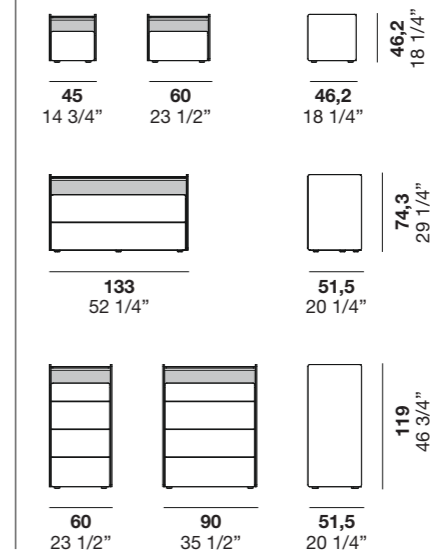

By Side

Sistema notte modulare dalle infinite possibilità compositive, By Side si adatta a ogni esigenza. Gli elementi possono essere a terra o sospesi, in appoggio o in sovrapposizione. Un progetto trasversale, arricchito da finiture raffinate e integrazione con il sistema letto Suite System 2.

Modular night system with endless compositional possibilities, By Side adapts to every need. The elements can be placed on the floor or suspended, stacked or simply rested. A versatile design, enriched by refined finishes and seamless integration with the Suite System 2 bed system.

design R&D Alf DaFrè





By Side gruppo notte / storage unit
 Fashion Wood Rovere Carbone e Laccato
 opaco Platino / Carbone oak Fashion Wood
 and matt Platino lacquer
 L/W150 P/D48 H75,1



Olivia poltroncina / armchair
 Tessuto Please 806 / Please 806 fabric
 L/W106 P/D93 H89
 → **Cat. Sofas / Occasional Tables /**
Armchairs

Esagona specchiera / mirror
 Verniciato Moka Shine / Moka Shine
 painted
 L/W80 P/D5 H69,3



By Side gruppo notte / storage units
Laccato opaco Arena / matt Arena lacquer
L/W150 P/D48 H65,1

Nobilitato Old Copper / Surfaced Old
Copper
L/W120 P/D48 H19,5

Fashion wood rovere Carbone / Carbone
oak Fashion Wood
L/W90 P/D48 H102,9
L/W90 P/D48 H37,3

By Side gruppo notte / storage units
Laccato opaco Fango e Nobilitato Old
Copper / matt Fango lacquer and Surfaced
Old Copper
L/W180 P/D48 H53,4

Laccato opaco Platino / matt Platino
lacquer
L/W150 P/D48 H72,9



Rim gruppo notte / storage units
Laccato opaco Platino / matt Platino
lacquer L/W40 P/D40 H52

Jet Set poltroncina / armchair
Tessuto Ranger 30 / Ranger 30 fabric
L/W77 P/D87 H80

By Side gruppo notte / storage units
Laccato opaco Modica, Laccato opaco
Platino e Laccato opaco Tortora / matt
Modica, Tortora and Platino lacquer
SX LH/W90 P/D48 H37,3
DX RH/W120 P/D48 H55,1

Suite System 2 boiserie / wall panels
Tessuto Ranger 28 / Ranger 28 fabric
L/W390 P/D44 H73,4
GL07 Piattaforma / platform
Tessuto Ranger 28 / Ranger 28 fabric
L/W171,5 P/D207,5 H31
→ Cat. Beds: Suite System 2 p. 246

Disco specchiera / mirror
Verniciato Moka Shine / Moka Shine painted
Ø76,5 P/D5,5



By Side gruppo notte / storage units
 Laccato opaco Platino e Fashion wood
 rovere Terra / matt Platino lacquer and
 Terra oak Fashion Wood
 L/W220 P/D48 H72,9

Laccato opaco Fango / matt Fango lacquer
 L/W120 P/D48 H85,1

By Side gruppo notte / storage units
 Laccato opaco Platino / matt Platino
 lacquer
 L/W210 P/D48 H85,1

Fashion wood rovere Terra / Terra oak
 Fashion Wood
 L/W90 P/D48 H126,3

Laccato opaco Fango / matt Fango lacquer
 L/W255 P/D48 H57,3



By Side gruppo notte / storage units
 Laccato opaco Platino / matt Platino
 lacquer
 L/W480 P/D48 H48,6

Denny pouf
 Tessuto Please 806 / Please 806 fabric
 Ø85 H37 Ø55 H42
 → Cat. Sofas / Occasional Tables /
 Armchairs

Neyō tavolino / occasional table
 Marmo di Carrara e struttura verniciato
 Moka Shine / Carrara marble and Moka
 Shine painted structure



By Side gruppo notte / storage units
 Nobilitato Metal Smoke e laccato opaco
 Fango / Surfaced Metal Smoke and matt
 Fango lacquer
 L/W150 P/D48 H78,6

By Side



By Side gruppo notte / storage units
 Nobilitato Old Copper / Surfaced Old
 Copper
 L/W210 P/D48 H78,6

Storage units

Suite System 2 boiserie / wall panels
 Fashion wood rovere Terra / Terra oak
 Fashion Wood
 L/W39 P/D44 H73,4
 → Cat. Beds: Suite System 2 p. 246



By Side gruppo notte / storage units
 Laccato opaco Cuoio e Fashion wood
 rovere Fossile / matt Cuoio lacquer and
 Fashion wood Fossile oak
 L/W180 P/D48 H72,9

Laccato opaco Cuoio / matt Cuoio lacquer
 L/W180 P/D48 H35,6

Nobilitato rovere Tortora / Surfaced
 Tortora oak
 L/W225 P/D48 H53,4

By Side

By Side si configura come il naturale completamento del letto Suite System 2, ma non solo. È una soluzione versatile, pensata per creare angoli beauty e spazi funzionali all'interno della zona notte, sempre riconoscibili per lo stile distintivo che contraddistingue l'intera collezione.

By Side is the natural complement to the Suite System 2 bed—but it's much more than that. It's a versatile solution designed to create beauty corners and functional areas within the bedroom, always recognisable by the distinctive style that defines the entire collection.

design R&D Alf DaFrè





Rim gruppo notte / storage units
Laccato micalizzato Palladio / Micalised
Palladio lacquer
Ø40 H52

Shift sedia / chair
Ecopelle Time 792 / Time 792 ecoleather
L/W67,5 P/D70,3 H68,7
→ **Cat. Sideboards / Tables / Chairs /
Writing desks**

Denny pouf
Tessuto Ranger 11 / Ranger 11 fabric
Ø55 H42
→ **Cat. Sofas / Occasional Tables /
Armchairs**

By Side gruppo notte / storage units
Laccato Platino opaco / matt Platino
lacquer
L/W285 P/D48 H55,6

Suite System 2 boiserie / wall panels
vano a giorno / open unit
Laccato opaco Platino / matt Platino lacquer
L/W330 P/D22,2 H83,4
→ **Cat. Beds: Suite System 2 p. 246**

Suite System 2 specchiera / mirror
L/W80 P/D5,5 H120



Raku divanetto / sofa
Tessuto Please 806 / Please 806 fabric
L/W158 P/D69 H75
→ **Cat. Sofas / Occasional Tables / Armchairs**

Neyō tavolino / occasional table
Marmo Carrara e struttura verniciato Moka Shine / Carrara marble and Moka Shine painted structure L/W60 P/D38 H42
→ **Cat. Sofas / Occasional Tables / Armchairs**

Raku sedia / chair
Tessuto Please 806 / Please 806 fabric
L/W55,5 P/D55 H80
→ **Cat. Sideboards / Tables / Chairs / Writing desks**

By Side gruppo notte / storage units
Laccato Fango opaco / matt Fango lacquer
L/W360 P/D48 H55,6

Suite System 2 boiserie / wall panels
Nobilitato Noce naturale / Sufaced Naturale walnut
→ **Cat. Beds: Suite System 2 p. 246**

Disco specchiera / mirror
Verniciato Moka Shine / Moka Shine painted
Ø96 P/D5,5



By Side gruppo notte / storage units
Laccato Origano opaco / matt Origano
lacquer L/W270 P/D48 H85,1

Suite System 2 boiserie e vano a giorno /
wall panels and open unit
Laccato opaco Origano / matt Origano
lacquer L/W270 P/D139 H22,2
→ Cat. Beds: Suite System 2 p. 246

Suite System 2 specchiera / mirror
L/W80 P/D5,5 H120

Rim gruppo notte / storage units
Laccato micalizzato Palladio / Micalised
Palladio lacquer Ø40 H52



By Side gruppo notte / storage unit
Laccato opaco Origano / matt Origano
lacquer L/W180 P/D48 H27,8
Suite system 2 boiserie / wall panels
Fashion wood Rovere Biscotto / Biscotto
oak Fashion Wood L/W180 P/D4,4 H55,6



By Side gruppo notte / storage unit
Laccato opaco Cuoio / matt Cuoio lacquer
L/W255 P/D48 H55,6
Suite System 2 boiserie e vano a giorno /
wall panels and open unit
Rovere colore opaco Platino / matt Platino
oak lacquer L/W315 P/D28,4 H139

Suite System 2 specchiera / mirror
L/W80 P/D22,2 H80
→ Cat. Beds: Suite System 2 p. 246

BY SIDE

design R&D Alf DaFrè

By Side è un sistema notte componibile caratterizzato da una vasta modularità. Gli elementi possono essere posizionati a terra o sospesi, singoli o in sovrapposizione per creare infinite composizioni.

By Side is a modular bedroom range with a wide range of options. The pieces can be floor-standing or wall-mounted, individually or stacked to create infinite compositions.

Materiali e finiture
Struttura: Nobilitati, Fashion wood, Roveri
laccati opachi, Laccati opachi e lucidi,
Laccati micalizzati.

Materials and finishes
Frame: Surfaced, Fashion Wood, matt
lacquered oak, matt and high-gloss lacquer,
micalised lacquer.

Gruppo letto / Bedroom suite

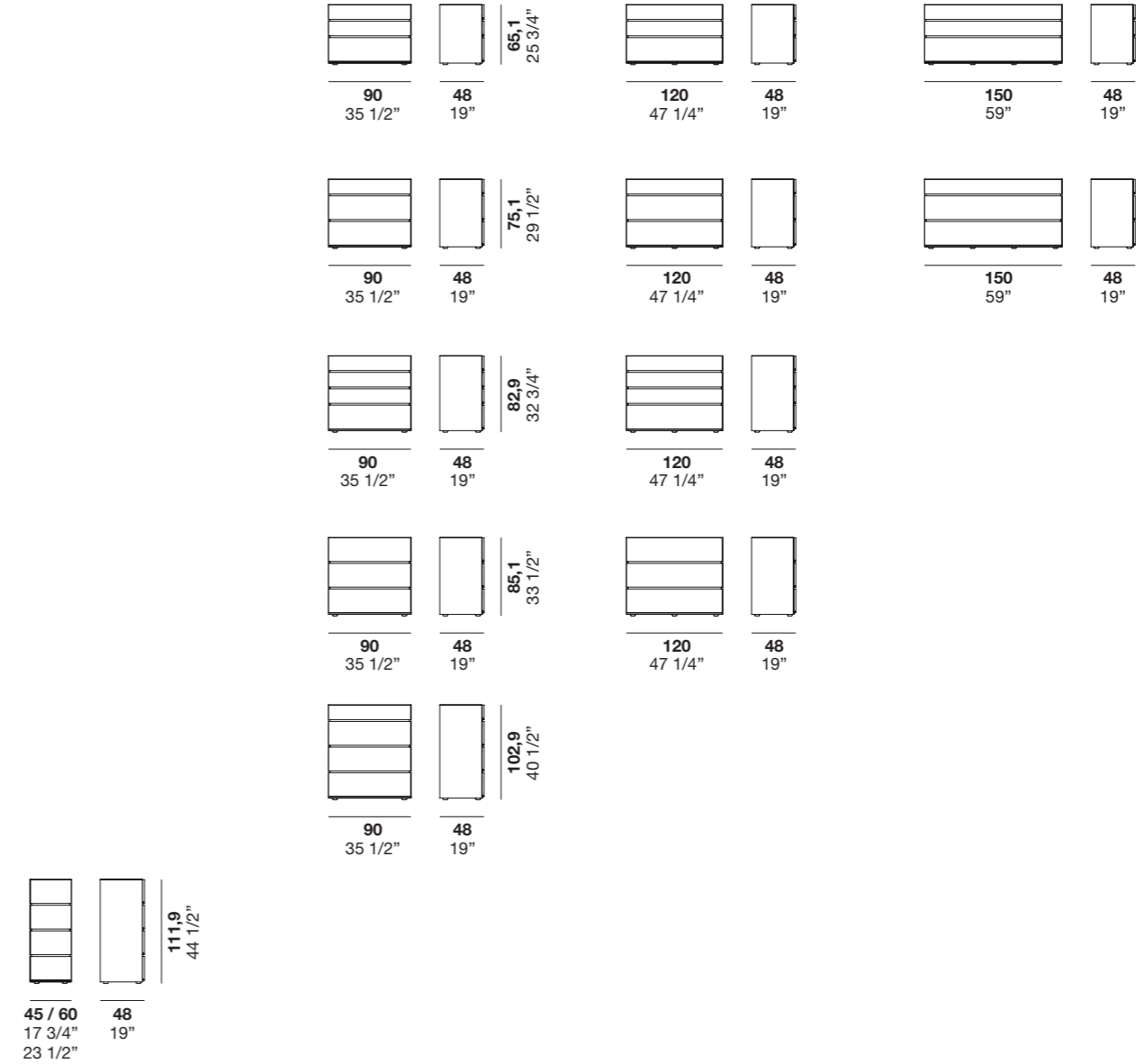
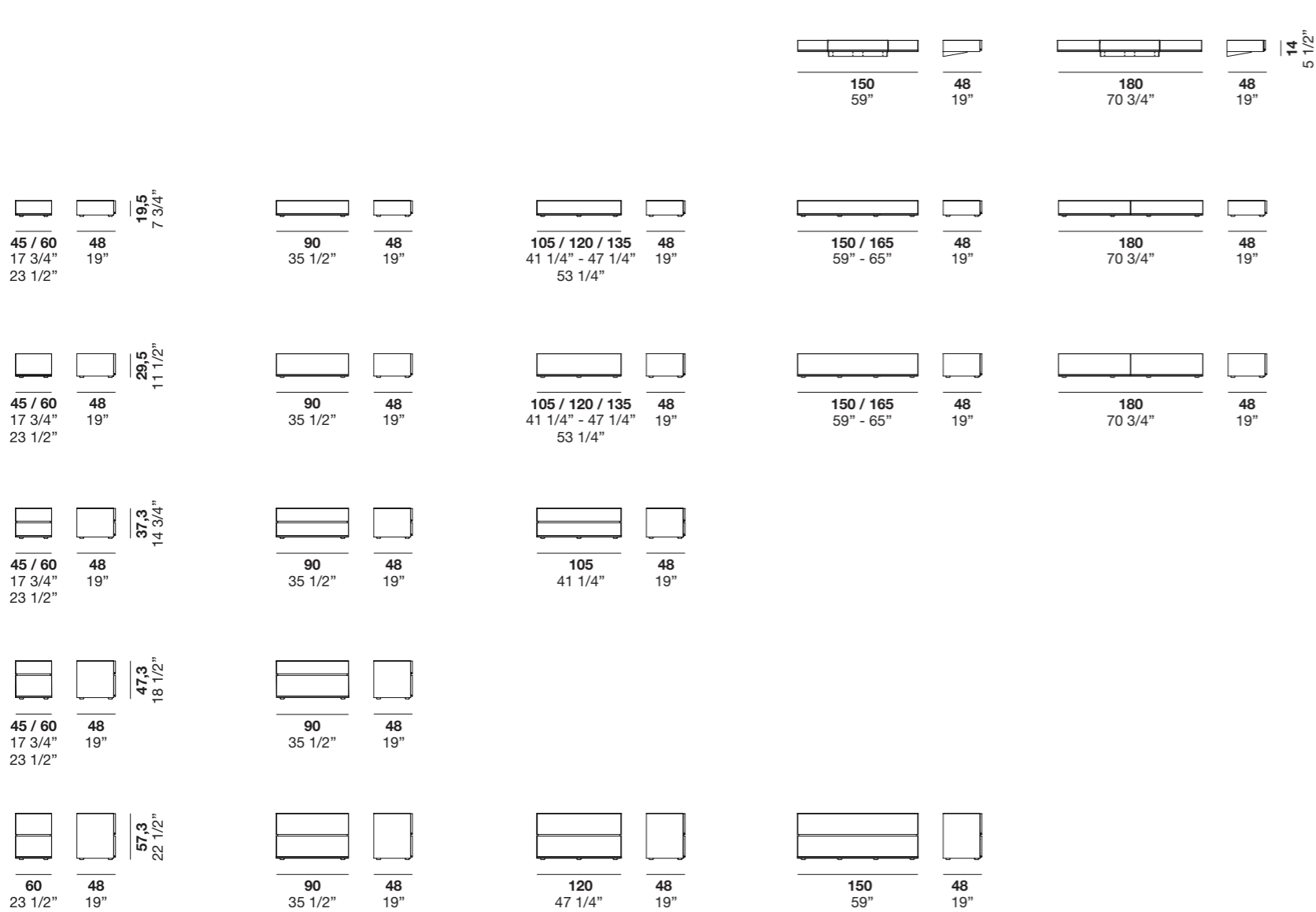

Nobu

Comodino e pouf insieme, Nobu è un contenitore trasformista che unisce funzione e ironia. La parte superiore imbottita nasconde un pratico vassoio in metallo, perfetto per piccoli oggetti. Rivestibile in tessuto, pelle o ecopelle, diventa un alleato versatile per arredare con stile.

Both bedside table and pouf, Nobu is a transformable storage unit that combines functionality with a touch of playfulness. The upholstered top conceals a practical metal tray, perfect for keeping small items within reach. Available in fabric, leather or eco-leather, it is a versatile accent piece that adds style and character to any space.

design Raffaella Mangiarotti





Nobu contenitore / storage unit
Tessuto Antibes 904 e vassoio laccato
micalizzato Nickel / Antibes 904 fabric and
micalised lacquer tray
L/W38,6 P/D42,6 H44



NOBU

design by Raffaella Mangiarotti

Nobu è un comodino / pouf imbottito con parte superiore removibile che "cela" un vassoio in metallo.

Nobu is an upholstered bedside table / footstool with a removable top that "conceals" a metal tray.

Materiali e finiture
 Rivestimento: Tessuti, Pelle, Ecopelle.
 Vassoio: Moka Shine, laccato micalizzato Nickel.

Materials and finishes
 Upholstery: Fabric, leather, ecoleather.
 Tray: Moka Shine, Nickel micalised lacquer.

Pouf-comodino / Pouf-bedside table

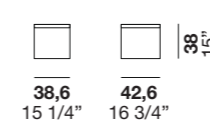
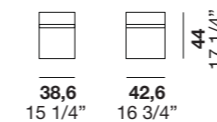

Adj

Forme curve e tagli inclinati definiscono il carattere distintivo di Adj. Il top, leggermente ribassato, si trasforma in un dettaglio di design che sottolinea la funzionalità del mobile. Le finiture materiche e le linee sinuose donano eleganza e morbidezza alla collezione, rendendola un elemento d'arredo sofisticato e al tempo stesso pratico. L'unico segno che percorre i frontali diventa un invito intuitivo all'apertura, espressione di un'estetica curata in ogni minimo dettaglio.

Curved lines and slanted cuts define Adj's distinctive character. The slightly recessed top becomes a refined design detail that enhances the unit's functionality. Textured finishes and flowing lines lend elegance and softness to the collection, making it both sophisticated and practical. A single groove runs across the front panels, offering an intuitive opening gesture—an expression of aesthetics refined down to the smallest detail.

design Bruna Vaccher

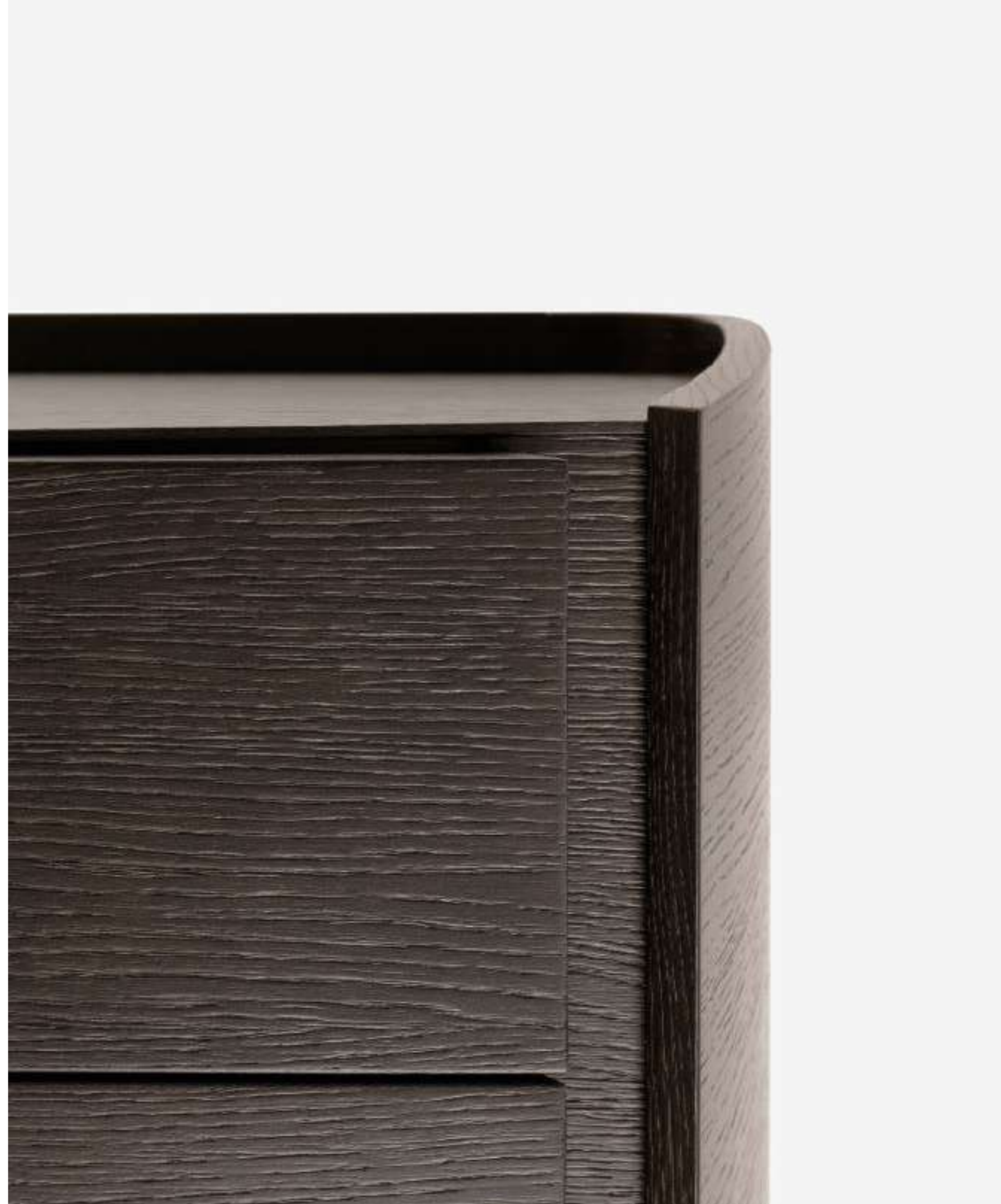



Adj gruppo notte / storage unit
 A sx Fashion wood Rovere Carbone e sopra
 Laccato opaco Modica / On the left Carbone
 oak Fashion Wood and above matt Modica
 lacquer L/W140 P/D54 H76

Neyō tavolino / occasional table
 Top marmo Carrara e struttura verniciato
 Moka Shine / Carrara marble top and Moka
 Shine painted structure
 L/W60 P/D38 H42
 → Cat. Sofas / Occasional Tables /
 Armchairs

Raku poltroncina / armchair
 Tessuto Nina 6 / Nina 6 fabric
 L/W84 P/D69 H75
 → Cat. Sofas / Occasional Tables /
 Armchairs



Adj gruppo notte / storage units
Fashion wood Rovere Carbone / Carbone
oak Fashion Wood
L/W140 P/D54 H76
L/W60 P/D46 H46
L/W74,2 P/D46 H123

Tuft tavolino / occasional table
Laccato opaco Nero / matt Nero lacquer
L/W40,3 P/D40,3 H46,3
→ Cat. Sofas / Occasional Tables /
Armchairs



Adj gruppo notte / storage units
Fashion wood Rovere Carbone / Carbone
oak Fashion Wood
L/W60 P/D46 H46
L/W140 P/D54 H76



Adj gruppo notte / storage units
Fashion wood Rovere Carbone e Top
laccato opaco Juta / Carbone oak Fashion
Wood and Matt Juta laquer top
L/W140 P/D54 H76



Adj gruppo notte / storage units
 Laccato opaco Platino, Modica e Cuoio /
 matt Platino, Modica and Cuoio lacquer
 L/W74,2 P/D46 H123
 L/W60 P/D46 H46
 L/W140 P/D54 H76

ADJ

design Bruna Vaccher

Le linee curve danno grande carattere a questo gruppo letto che si distingue anche per l'originale taglio inclinato della parte superiore.
 In questo modo il top diventa anche un pratico portaoggetti delimitato dalle linee del mobile stesso.

Materiali e finiture
 Struttura: Fashion wood, Roveri laccati opachi, Laccati opachi.
 Per versione Fashion wood disponibile top laccato opaco.

The curved lines add real character to this bedroom suite, which also features an original slanted top.
 This turns the top into an extra practical storage and display surface, framed by the structure of the unit itself.

Materials and finishes
 Frame: Fashion Wood, matt lacquered oak, matt lacquer.
 Matt laquer top available for Fashion wood version.

Gruppo letto / Bedroom suite

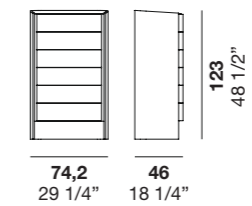
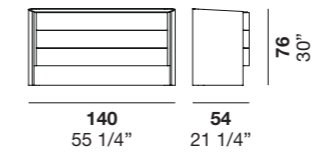
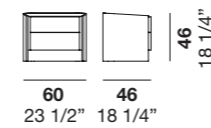

Da-Do System

Estrema modularità e rigore formale: Da-Do System è il sistema notte per eccellenza. Sovrapponibile o sospeso, combina finiture esterne con top e gole a contrasto, offrendo composizioni personalizzate e versatili. Una collezione pensata per ottimizzare lo spazio e definire lo stile attraverso un'estetica precisa.

Extreme modularity and formal rigor: Da-Do System is the ultimate bedroom storage solution. Stackable or wall-mounted, it combines outer finishes with contrasting tops and grooves, offering personalized and versatile compositions. A collection designed to optimize space and define style through a precise, architectural aesthetic.

design R&D Alf DaFrè





Da-Do system gruppo notte / storage units
Nobilitato Old brass e laccato opaco Juta /
Surfaced Old brass and matt Juta lacquer
L/W148 P/D53 H74,4

Disco specchiera / mirror
Verniciato Moka Shine / Moka Shine painted
Ø76,5 P/D5,5

Jet set poltroncina / armchair
Tessuto Smile 36 / Smile 36 fabric
L/W77 P/D87 H80



Da-Do system gruppo notte / storage units
Noce naturale e laccato opaco Piombo /
Natural walnut and matt Piombo lacquer
L/W90 P/D45 H37

Da-Do system gruppo notte / storage units
Laccato opaco Sahara / matt Sahara lacquer
L/W45 P/D45 H47

Da-Do system gruppo notte / storage units
Nobilitato Old brass e laccato opaco Juta /
Surfaced Old brass and matt Juta lacquer
L/W148 P/D53 H74,4



Da-Do system

Contenitori notte / Storage units



Da-Do system gruppo notte / storage units
Laccato opaco Sahara / matt Sahara lacquer
L/W45 P/D45 H47



Da-Do system gruppo notte / storage units
Fashion wood rovere Fossile / Fashion wood
Fossile oak
L/W90 P/D53 H101,7

Shift sedia / chair
Ecopelle Time 792 / Time 792 ecoleather
L/W49 P/D54,7 H76,8
→ Cat. Sofas / Occasional Tables /
Armchairs



Da-Do system gruppo notte / storage units
Laccato opaco Arena / matt Arena lacquer
L/W90 P/D53 H119
L/W120 P/D45 H19,8

Laccato micalizzato Palladio / Micalised
Palladio lacquer
L/W45 P/D45 H37,1

Fashion wood rovere Fossile / Fashion
wood Fossile oak
L/W148 P/D53 H74,4

Da-Do system gruppo notte / storage units
Laccato opaco Platino / matt Platino lacquer
L/W90 P/D53 H101,7

Laccato opaco Modica e laccato
micalizzato Palladio / matt Modica lacquer
and micalised Palladio lacquer
L/W90 P/D53 H56,5

Nobilitato Noce naturale / Sufaced
Naturale walnut
L/W133 P/D45 H34,3



Da-Do system gruppo notte / storage units
Laccato Platino lucido e Fashion wood rovere
Carbone / High-gloss Platino lacquer and
Carbone oak Fashion Wood
L/W238 P/D53 H64,4

Denny pouf
Tessuto Ranger 8 / Ranger 8 fabric
Ø55 H42
→ Cat. Sofas / Occasional Tables /
Armchairs



Da-Do system gruppo notte / storage units
Noce naturale e laccato opaco Piombo /
Naturale walnut and matt Piombo lacquer
L/W90 P/D45 H37



Denny pouf
 Tessuto Nina 18 / Nina 18 fabric
 Ø55 H42
 → Cat. Sofas / Occasional Tables /
 Armchairs

Da-Do system gruppo notte / storage units
 Laccato opaco Amaranto e laccato opaco
 Nude / matt Amaranto and Nude lacquer
 SX LH/W90 P/D45 H19,8
 DX RH/W90 P/D45 H37,1

Suite System 2 boiserie / wall panels
 Tessuto Nina 18 / Nina 18 fabric
 L/W360 P/D44 H91,2

GL07 Piattaforma / platform
 Tessuto Nina 18 / Nina 18 fabric
 L/W171,5 P/D207,5 H31
 → Cat. Beds: Suite System p. 246



Da-Do system gruppo notte / storage units
Laccato opaco Amaranto e laccato opaco Nude / matt Amaranto and Nude lacquer
SX LH/W90 P/D45 H19,8
DX RH/W90 P/D45 H37,1

Suite System boiserie / wall panels
Tessuto Nina 18 / Nina 18 fabric
L/W360 P/D44 H91,2

GL07 Piattaforma / platform
Tessuto Nina 18 / Nina 18 fabric
L/W171,5 P/D207,5 H31
→ Cat. Beds: Suite System 2 p. 246



DA-DO SYSTEM

design R&D Alf DaFrè

Da-Do System è un gruppo letto componibile caratterizzato dalla grande modularità e versatilità. Rigoroso e lineare può abbinare due finiture, una per l'esterno e una per top e gola che funge da presa per l'apertura. Semplicemente sovrapponendo i moduli o fissandoli a parete, Da-Do System offre infinite possibilità compositive per sfruttare al meglio lo spazio e personalizzare in modo unico l'ambiente notte.

Materiali e finiture

Struttura: Nobilitati, Fashion wood, Roveri laccati opachi, Laccati opachi e lucidi, Laccati micallizzati.

Da-Do System è a bedroom suite with a versatile, ultra-modular design. Rigorous and linear, it can feature two matching finishes: one for the exterior and one for the top and groove, which acts as a grip for opening the front. By stacking the units or securing them to the wall, Da-Do System offers infinite composition options to make the best use of the available space and customise the bedroom in a unique fashion.

Materials and finishes

Frame: Surfaced, Fashion Wood, matt lacquered oak, matt and high-gloss lacquer, micalised lacquer.

Gruppo letto / Bedroom suite

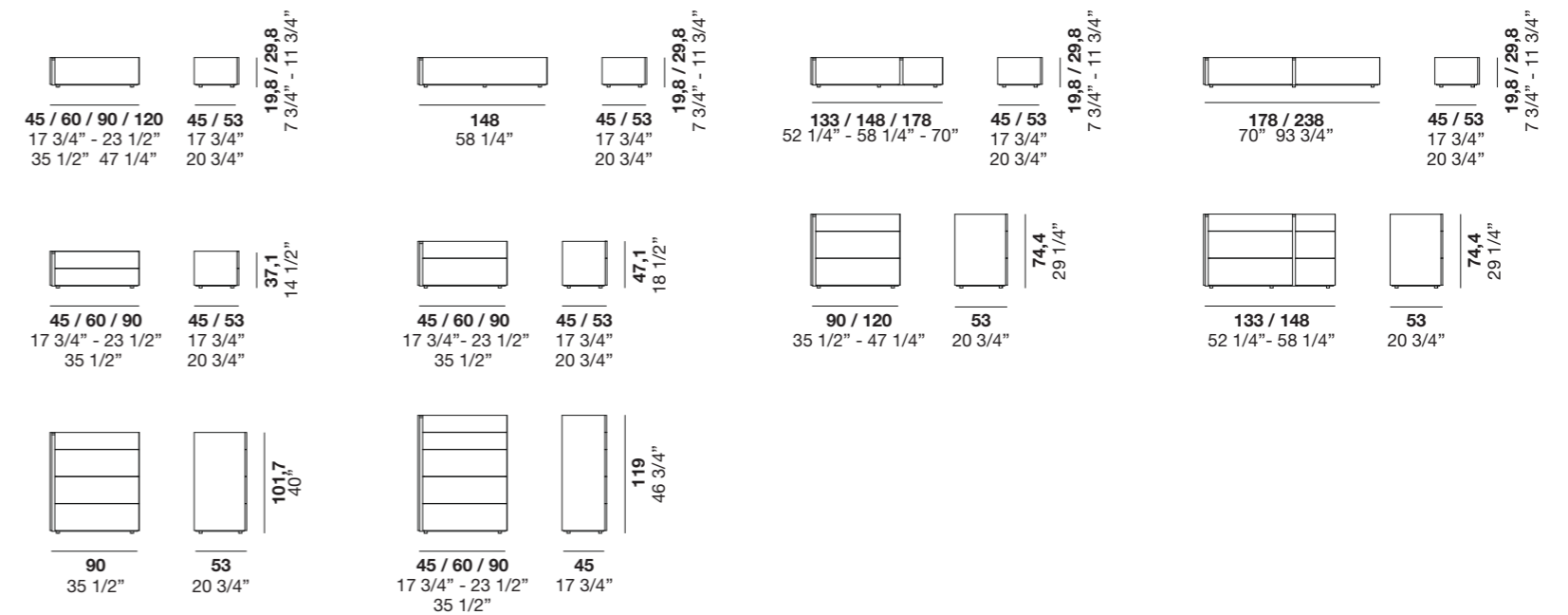

Da-Do system gruppo notte / storage units
Laccato opaco Amaranto e laccato opaco Nude / matt Amaranto and Nude lacquer
L/W178 P/D45 H34,3

Esagona specchiera / mirror
Verniciato Moka Shine / Moka Shine painted
L/W80 P/D5 H69,3

Denny pouf
Tessuto Nina 18 / Nina 18 fabric
Ø55 H42
→ Cat. Sofas / Occasional Tables / Armchairs

Fil

Fil è essenziale, leggero e minimal. Le proporzioni sottili e la pulizia delle linee delineano una collezione elegante e discreta. Perfetto in abbinamento a sistemi boiserie e piattaforme letto, Fil interpreta la zona notte con sobrietà e rigore formale.

Fil is essential, lightweight and minimal. Its slender proportions and clean lines define an elegant, understated collection. Perfect when paired with wall panel systems and bed platforms, Fil brings a sense of composure and formal clarity to the bedroom space.

design R&D Alf DaFrè





Fil gruppo notte / storage units
 Laccato opaco Tè verde / matt Tè Verde
 lacquer
 L/W270 P/D48 H85,4

Suite System 2 vano a giorno / open unit
 Laccato opaco Origano / matt Origano
 lacquer
 L/W180 P/D22,2 H27,8

Suite System 2 boiserie / wall panels
 Fashion wood rovere Naturale / Naturale
 oak Fashion Wood
 → Cat. Beds: Suite System 2 p. 246

Denny pouf
 Tessuto Taiga 01 colore 30/1 / Taiga 01
 colour 30/1 fabric Ø55 H42
 → Cat. Sofas / Occasional Tables /
 Armchairs



Fil gruppo notte / storage units
Laccato opaco Cuoio / matt Cuoio lacquer
L/W45 P/D48 H36,9

Fil gruppo notte / storage units
Laccato opaco Tortora / matt Tortora
lacquer
L/W150 P/D48 H74

Orbit scrittoio / desk
Fashion wood rovere Fossile / Fashion
wood Fossile oak
L/W135 P/D60 H78,5



Fil gruppo notte / storage units
Laccato opaco Cuoio / matt Cuoio lacquer
L/W45 P/D48 H36,9

Laccato opaco Tortora / matt Tortora
lacquer
L/W150 P/D48 H74

Orbit scrittoio / desk
Fashion wood rovere Fossile / Fashion
wood Fossile oak
L/W135 P/D60 H78,5



Fil gruppo notte / storage units
Laccato opaco Cuoio / matt Cuoio lacquer
L/W90 P/D48 H27,8

Laccato opaco Fango / matt Fango
lacquer
L/W60 P/D48 H126,2

Fashion wood rovere Terra / Terra oak
Fashion Wood
L/W60 P/D48 H46,9

Nobilitato rovere Platino / Surfaced
Platino oak
L/W60 P/D48 H46,9

Fil gruppo notte / storage units
Laccato opaco Fango e Nobilitato rovere
Platino / matt Fango lacquer and Surfaced
Platino oak
L/W90 P/D48 H103,2

Laccato opaco Tortora e Fashion wood
rovere Terra / matt Tortora lacquer and
Terra oak Fashion Wood
L/W180 P/D48 H35,6

Laccato opaco Platino / matt Platino
lacquer
L/W135 P/D48 H53,4



Fil gruppo notte / storage units
Laccato opaco Bianco / matt Bianco
lacquer
L/W150 P/D48 H75,4
L/W60 P/D48 H118,2

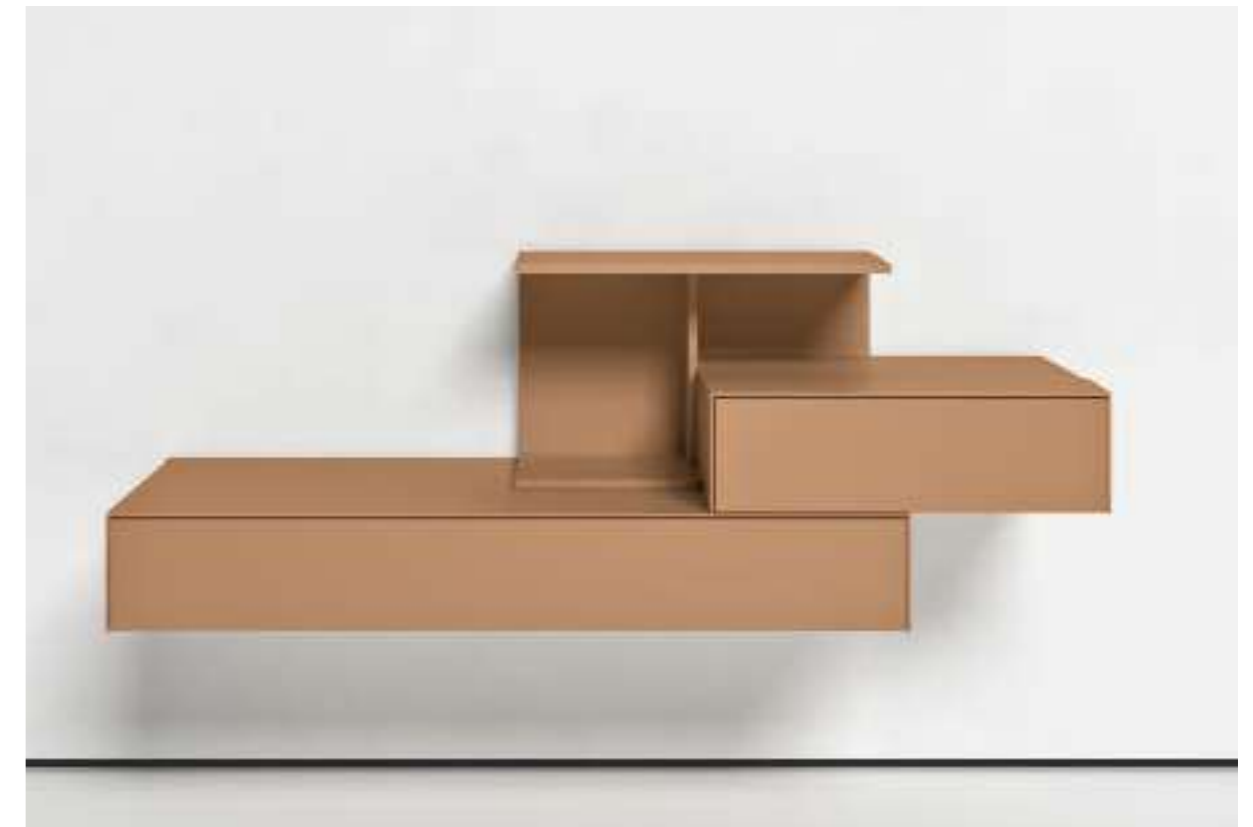

Fil gruppo notte / storage units
Laccato opaco Cuoio naturale e Fango /
matt Cuoio Naturale and Fango lacquer
L/W180 P/D48 H91,8

Laccato opaco Cuoio naturale / matt Cuoio
Naturale Lacquer
L/W150 P/D48 H53,4



Fil gruppo notte / storage units
Laccato opaco Arena / matt Arena lacquer
L/W90 P/D48 H19,8

Suite System 2 boiserie / wall panels
Pelle Lord 9340 e Laccato opaco Agatha /
Lord 9340 leather and matt Aghata lacquer
L/W360 P/D22,2 H119
→ Cat. Beds: Suite System 2 p. 246

P18 Piattaforma / platform
Laccato opaco Agatha / matt Aghata
lacquer
L/W168,5 P/D204,5 H31,5



Rim gruppo notte / storage units
Laccato micallizzato Palladio / Palladio
micalised lacquer
Ø40 H52

Fil gruppo notte / storage units
Laccato opaco Platino / matt Platino lacquer
L/W180 P/D48 H45,6
Fil specchio / mirror
Verniciato Moka Shine / Moka Shine painted
L/W60 P/D5 H120

Atlas letto / bed
Tessuto Rubens 03 e Fashion wood Rovere
Carbone / Rubens 03 fabric and Fashion
wood Carbone oak L/W185,9 P/D224,5 H97,5
→ **Cat. Beds: Atlas p. 114**

Denny pouf
Tessuto Regal E037 / Regal E037 fabric
Ø55 H42
→ **Cat. Sofas / Occasional Tables /
Armchairs**



Fil gruppo notte / storage units
Laccato opaco Tè verde / matt Tè Verde lacquer
L/W180 P/D48 H75,4

Fil specchiera / mirror
Verniciato Moka Shine / Moka Shine painted lacquer
L/W45 H150

FIL

design R&D Alf DaFrè

Si distingue per la linea filante e minimale. Fil è un gruppo letto componibile con una vasta modularità. Può avere due versioni di piedi o essere appeso a parete, creando ampie possibilità compositive. Si caratterizza inoltre per la scelta nell'apertura tra la piccola maniglia in metallo in posizione asimmetrica o il push-pull.

Materiali e finiture
Struttura: Nobilitati, Fashion wood, Roveri laccati opachi, Laccati opachi.

It boasts a sleek, minimalist design. Fil is a highly modular bedroom suite which can be used in a wide array of combinations. There are two floor-standing options and it can be wall mounted, creating many compositions. There are also two ways to open the units, either using the small, asymmetric metal handle or the push-pull mechanism.

Materials and finishes
Frame: Surfaced, Fashion Wood, matt lacquered oak, matt lacquer.

Gruppo letto / Bedroom suite

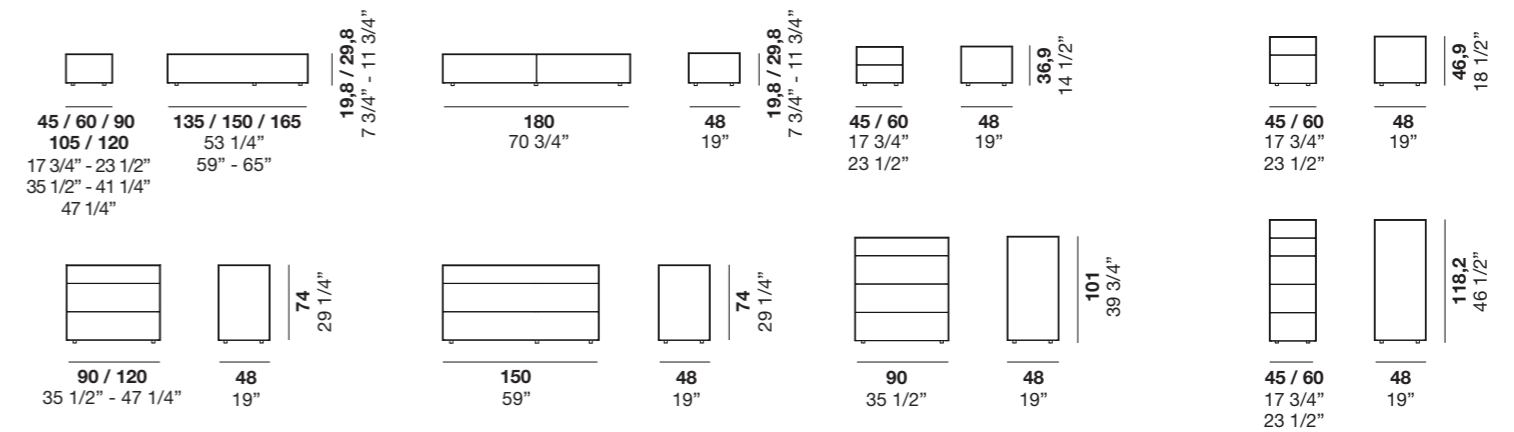

Gruppo letto con piedi in metallo / Bedroom suite with metal feet

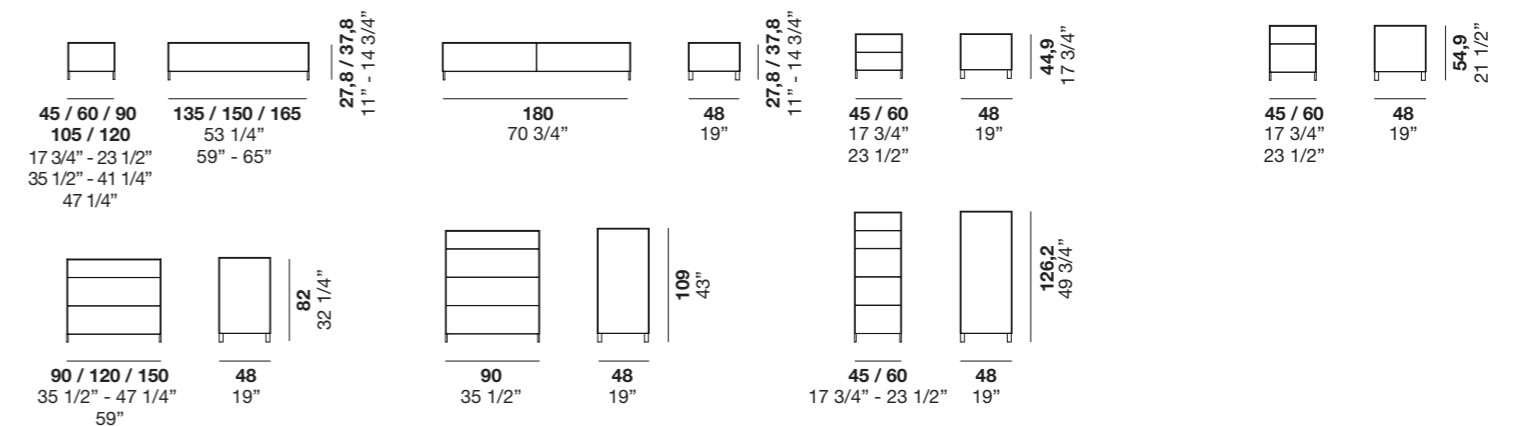

Hobby

Hobby interpreta la zona notte con spirito dinamico e soluzioni compatte. Le sue proporzioni contenute lo rendono ideale anche in spazi ridotti, senza rinunciare a estetica e funzionalità.

I frontali lineari e le finiture curate conferiscono al gruppo un carattere sobrio e trasversale, facilmente abbinabile. Le strutture in metallo e le caratterizzanti maniglie a occhiello definiscono i tratti di Hobby. Una proposta pensata per chi cerca essenzialità, ordine e stile in un unico gesto progettuale.

Hobby brings a dynamic spirit and compact solutions to the bedroom space. Its contained proportions make it ideal even for smaller interiors, without compromising on style or functionality. Clean-lined fronts and refined finishes give the collection a discreet, versatile character. The metal base structures and distinctive eyelet handles further define Hobby's identity. A solution designed for those who seek simplicity, order, and style in a single, thoughtful design gesture.

design Haften Studio



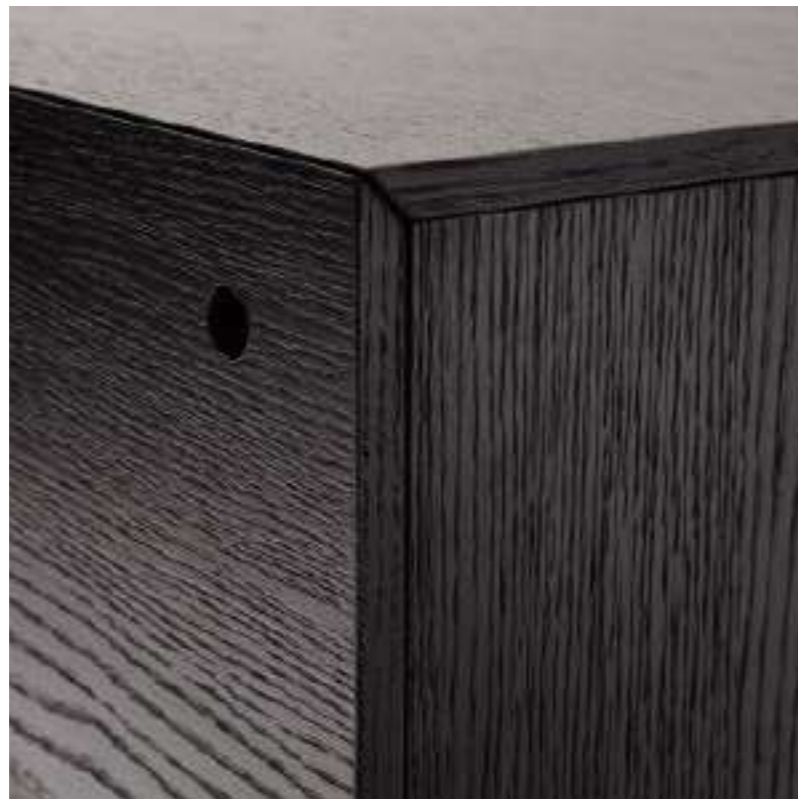

Hobby gruppo notte / storage unit
 Fashion wood rovere Fossile e basamento
 verniciato Moka Shine / Fashion wood
 Fossile oak and Moka Shine painted base
 L/W134,2 P/D52,7 H75,4

Disco specchiera / mirror
 Verniciato Moka Shine / Moka Shine
 painted
 Ø76,5 P/D5,5
 Ø50 P/D5,5

Denny pouf
 Tessuto Senky 002 / Senky 002 fabric
 Ø55 H42
 → Cat. Sofas / Occasional Tables /
 Armchairs





Denny pouf
Tessuto Senky 002 / Senky 002 fabric
Ø 55 H42
→ Cat. Sofas / Occasional Tables /
Armchairs

Disco specchiera / mirror
Verniciato Moka Shine / Moka Shine painted
Ø 76,5 P/D 5,5
Ø 50 P/D 5,5

Hobby gruppo notte / storage units
Fashion wood Rovere Fossile e basamento
verniciato Moka Shine / Fashion wood Fossile
oak and Moka Shine painted base
L/W134,2 P/D52,7 H75,4 L/W55,7 P/D44 H42

Orion letto / bed
Tessuto Antibes 805 / Antibes 805 fabric
L/W177 P/D219 H115
→ Cat. Beds: Orion p. 142

Disco specchiera / mirror
Verniciato Moka Shine / Moka Shine painted
Ø76,5 P/D5,5
Ø50 P/D5,5



Hobby gruppo notte / storage units
Fashion wood rovere Fossile e verniciato
Moka Shine / Fashion wood Fossile oak and
Moka Shine painted base

L/W41,7 P/D44 H42
L/W41,7 P/D44 H42
L/W134,2 P/D52,7 H75,4

Raku poltroncina / armchair
Tessuto Rubens 08 / Rubens 08 fabric
L/W84 P/D69 H75
→ Cat. Sofas / Occasional Tables /
Armchairs



Hobby gruppo notte / storage units
A sinistra: tipologie di maniglia / On the left: handles
Sopra: tipologie di basamento / Above: bases type
L/W41,7 P/D44 H42



Hobby gruppo notte / storage units
Laccato Piombo opaco / matt Piombo lacquer
L/W79,8 P/D52,7 H99,8
L/W134,2 P/D52,7 H75,4

Fashion wood rovere Terra / Terra oak
Fashion Wood
L/W79,8 P/D52,7 H99,8

Laccato opaco Nude / matt Nude lacquer
L/W41,7 P/D44 H42

HOBBY

design Haften Studio

Un gruppo che unisce un design minimale e un' eleganza rigorosa, caratterizzato da elementi ricercati, come il basamento in metallo e le originali maniglie.

This storage unit combines minimalist design with pure elegance, boasting sophisticated details such as the metal base and original handles.

Materiali e finiture
Struttura: Nobilitati, Fashion wood, Roveri laccati opachi, Laccati opachi.
Basamento: verniciato bianco, verniciato Moka Shine, Laccati opachi.
Vassoio inferiore: verniciato bianco, verniciato Moka Shine.

Materials and finishes
Frame: Surfaced, Fashion Wood, matt lacquered oak, matt lacquer.
Base: Bianco painted, Moka Shine painted, matt lacquer.
Lower tray: Bianco painted, Moka Shine painted.

Gruppo letto / Bedroom suite

Gruppo letto con basamento / Bedroom suite with base

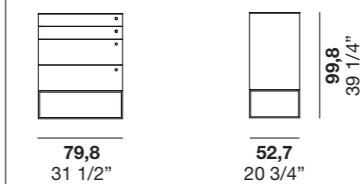
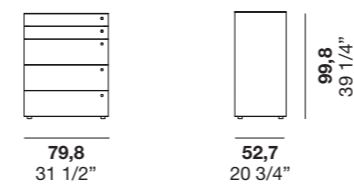
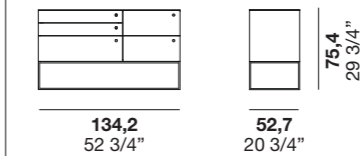
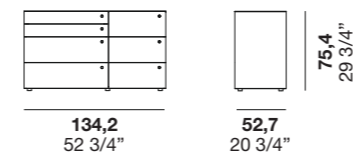
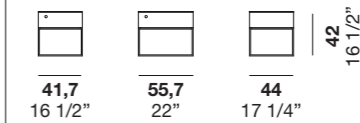
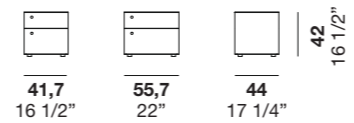

Olis

Design pulito e lineare per Olis, un gruppo notte che privilegia l'equilibrio formale e la matericità delle superfici. Le geometrie rigorose sono addolcite dai frontali cassetto stondati, mentre le numerose finiture disponibili permettono abbinamenti raffinati e sempre armonici.

Olis features a clean, linear design that highlights formal balance and the tactile appeal of its surfaces. Rigorous geometries are softened by rounded drawer front, while the wide range of available finishes allows for refined and harmonious combinations in any setting.

design Bruna Vaccher





Olis gruppo notte / storage units
Laccato opaco Nude / matt Nude lacquer
L/W125,2 P/D54,1 H75

Milano 2 letto / bed
Tessuto Nina 39 / Nina 39 fabric
L/W184 P/D234,8 H94,3
→ Cat. Beds: Milano 2 p. 072

Shift poltroncina / armchair
Tessuto Nina 39 / Nina 39 fabric
L/W67,5 P/D70,3 H68,7
→ Cat. Sofas / Occasional Tables /
Armchairs





Olis gruppo notte / storage units
Fashion wood Rovere Naturale e gola
laccato Cuoio opaco / Naturale oak Fashion

Wood and matt Cuoio lacquer groove
L/W125,2 P/D54,1 H75
L/W55,2 P/D44,7 H46,4



OLIS

design Bruna Vaccher

Gruppo notte composto da comò e comodino caratterizzati da linee curve. È previsto in tutte le finiture laccate e i legni fashion wood.

Materiali e finiture

Struttura: Fashion wood, Roveri laccati opachi, Laccati opachi.

A bedroom suite made up of a dresser and bedside table featuring curved lines. It is available in all lacquered and Fashion Wood finishes.

Materials and finishes

Frame: Fashion Wood, matt lacquered oak, matt lacquer.

Gruppo letto / Bedroom suite

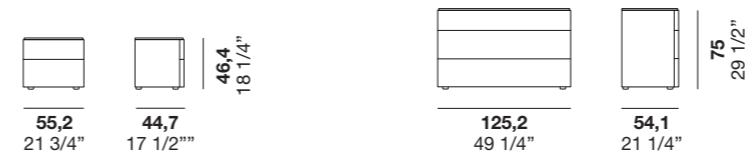

Rim

Compatto e cilindrico, Rim è un contenitore dal design scultoreo. La sua forma nasconde una grande funzionalità, diventando comodino o elemento d'accento. Disponibile in laccato opaco, micalizzato o Fashion Wood, si inserisce perfettamente in ambienti moderni dal gusto essenziale, permettendo combinazioni inedite tra piani e struttura.

Compact and cylindrical, Rim is a storage unit with a sculptural design. Its shape conceals remarkable functionality, serving as a bedside table or an accent piece. Available in matt lacquer, mica lacquer or Fashion Wood, it integrates perfectly into modern interiors with an essential aesthetic, offering original combinations between tops and structure.

design Enrico Cesana





Rim gruppo notte / storage units
 FW Rovere biscotto e Laccato opaco
 Anfora / FW Biscotto Oak and Mat Anfora
 laquer
 Ø40 H52

Paal letto / bed
 Fashion wood Rovere Biscotto e Laccato
 opaco Anfora / Biscotto oak Fashion
 wood and matt Anfora lacquer
 L/W172,5 P/D221,8 H100
 → Cat. Beds: Paal p. 026



Rim gruppo notte / storage units
 Laccato micallizzato Palladio / Palladio
 micallised lacquer
 Ø40 H52

Yume letto / bed
 Tessuto Iris 302 / Iris 302 fabric
 L/W192 P/D230 H102
 → Cat. Beds: Yume p. 082



RIM

design Enrico Cesana

Rim è un comodino con anta o vano a giorno, si differenzia per la linea curva e le dimensioni compatte. La possibilità del bicolore ne esalta le linee e ne amplia la versatilità.

Materiali e finiture
 Struttura: Nobilitati, Noce, Fashion wood, Roveri laccati opachi, Laccati opachi, Laccati micalizzati.
 Disponibile Top Laminam o Neolith.

Rim is a bedside table with a door or open compartment. It stands out for its curved lines and compact size. The two-tone option brings out its shape and makes it a truly versatile piece.

Materials and finishes
 Frame: Surfaced, Walnut, Fashion Wood, matt lacquered oak, matt lacquer, micalised lacquer.
 Laminam or Neolith top available.

Gruppo letto / Bedroom suite

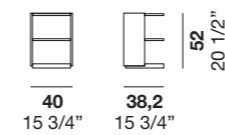
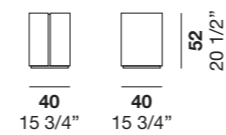

Rim

Storage units

Timeless

Timeless è un omaggio alla sobrietà senza tempo. Le proporzioni bilanciate, la pulizia dei volumi e la qualità delle finiture fanno di questa collezione un unicum di stile ed eleganza. Ogni elemento è pensato per durare e valorizzare con discrezione l'ambiente notte grazie anche alla caratteristica giunzione tra fianco top e cassetto che si incontrano in linee pulite.

Timeless is a tribute to understated, enduring elegance. Balanced proportions, clean volumes and refined finishes make this collection a unique expression of style and sophistication. Each piece is designed to last and discreetly enhance the bedroom space, thanks also to the distinctive junction where side panel, top and drawer meet in seamless, refined lines.

design Enrico Cesana





Timeless gruppo notte / storage unit
Laccato opaco Arena / matt Arena lacquer
L/W145 P/D55 H70

Esagona specchiera / mirror
Verniciato Moka Shine / Moka Shine
painted
L/W80 P/D5 H69,3



Esagona specchio / mirror
Verniciato Moka Shine / Moka Shine
painted
L/W80 P/D5 H69,3

Timeless gruppo notte / storage units
Laccato opaco Arena / matt Arena lacquer
L/W60 P/D45 H30,9
L/W145 P/D55 H70

Xilo 2 letto / bed
Fashion wood Rovere Fossile e Pelle
Scamosciata Seppia / Fashion wood Fossile
oak and Seppia suede

L/W174,5 P/D216 H95,2
→ Cat. Beds: Xilo 2 p. 232



Timeless gruppo notte / storage units
Laccato opaco Arena / matt Arena lacquer
L/W60 P/D45 H30,9
L/W145 P/D55 H70
L/W60 P/D45 H36

Malmo tavolino / occasional table
Laccato opaco Arena / matt Arena lacquer
L/W42 P/D42 H50
→ **Cat. Sofas / Occasional Tables /
Armchairs**



Timeless gruppo notte / storage units
Fashion wood rovere terra / Fashion wood terra oak
L/W90 P/D55 H111



Timeless gruppo notte / storage units
Fashion wood Rovere Terra / Terra oak
Fashion Wood

L/W90 P/D45 H111
L/W60 P/D45 H30,9
L/W145 P/D55 H70

Laccato opaco Fango / matt Fango lacquer
L/W90 P/D55 H111
L/W60 P/D45 H36

TIMELESS

design Enrico Cesana

Timeless è un gruppo letto dal disegno sempre attuale con stondatura e sagomatura dei fianchi e maniglia in metallo. Disponibile in variante comodino comò e settimanale in diverse misure.

Materiali e finiture
Struttura: Fashion wood, Roveri laccati opachi, Laccati opachi.

Timeless is an on-trend bedroom suite with shaped and rounded side panels and a metal handle. Available as a bedside table, dresser and chest of drawers in various sizes.

Materials and finishes
Frame: Fashion Wood, matt lacquered oak, matt lacquer.

Gruppo letto / Bedroom suite

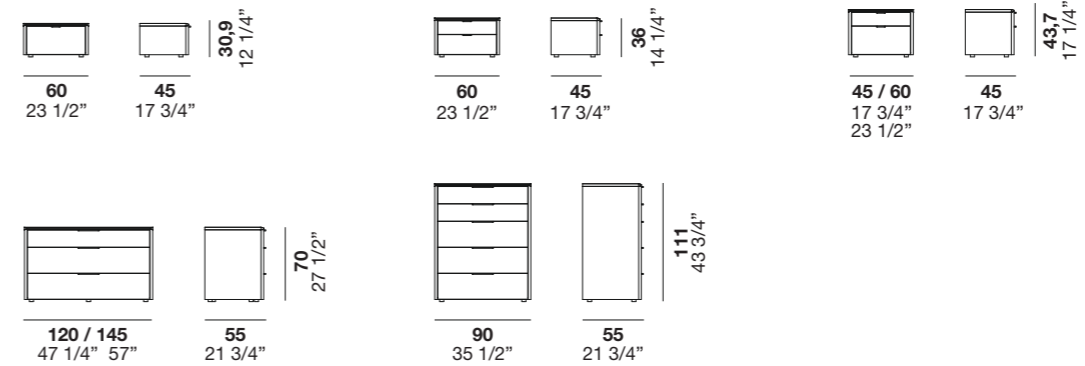

Twice

Twice ha un disegno caratterizzato dalle forme rigorose dove il segno grafico è l'invito per l'apertura e al tempo stesso diventa tratto iconico della collezione. Finiture e colori permettono la personalizzazione rendendolo versatile ad ogni stile d'arredo.

Twice features a design defined by clean, rigorous lines, where the graphic detail acts both as a functional opening and as the iconic signature of the collection. Finishes and colours allow for full customization, making it a versatile solution for any interior style.

design R&D Alf DaFrè





Twice gruppo notte / storage unit
Fashion wood rovere Fossile / Fashion
wood Fossile oak
L/W150 P/D54 H74,2

Disco specchiera / mirror
Verniciato Moka Shine / Moka Shine painted
Ø76,5 P/D5,5



Twice gruppo notte / storage units
Laccato opaco Modica / matt Modica
lacquer
L/W150 P/D54 H74,2
L/W64 P/D47,4 H44,4

Milano 2 letto / bed
Pelle Lord 9130 / Lord 9130 leather
L/W184 P/D234,8 H94,3
→ Cat. Beds: Milano 2 p. 072



Twice gruppo notte / storage units
Laccato opaco Modica / matt Modica
lacquer
L/W64 P/D47,4 H44,4

Fashion Wood rovere Carbone / Carbone
oak Fashion Wood
L/W150 P/D54 H74,2

Denny pouf
Pelle Lord 9100 / Lord 9100 leather
Ø85 H37
→ Cat. Sofas / Occasional Tables /
Armchairs



Twice gruppo notte / storage units
Laccato opaco Modica / matt Modica
lacquer
L/W64 P/D47,4 H44,4

Milano 2 letto / bed
Pelle Lord 9130 / Lord 9130 leather
L/W184 P/D234,8 H94,3
→ Cat. Beds: Milano 2 p. 072





Twice gruppo notte / storage units
 Fashion Wood Rovere Biscotto e laccato
 opaco Origano / Biscotto oak Fashion Wood

and matt Origano lacquer
 L/W64 P/D47,4 H44,4
 L/W64 P/D47,4 H123,8

Morrison 2 letto / bed
 Tessuto Iris 403 / Iris 403 fabric
 L/W0197 P/D229 H104
 → Cat. Beds: Morrison 2 p. 130



Twice gruppo notte / storage units
 Fashion wood rovere Fossile / Fashion wood Fossile oak
 L/W150 P/D54 H74,2
 L/W64 P/D47,4 H123,8

Laccato opaco Piombo e laccato micalizzato Oro / matt piombo lacquer and micalised Oro lacquer
 L/W64 P/D47,4 H35,9

Laccato lucido Piombo e laccato micalizzato Oro / High-gloss Piombo lacquer and micalised Oro lacquer
 L/W64 P/D47,4 H123,8

Laccato opaco Carta da zucchero / matt Carta Da Zucchero lacquer
 L/W64 P/D47,4 H44,4

TWICE

design R&D Alf DaFrè

Comodini, comò e settimanale lineari e ben proporzionati sfruttano una "catena" come presa per una agevole apertura. Tale rientranza caratterizza ulteriormente il mobile nella versione con finitura in contrasto.

Materiali e finiture

Struttura: Fashion wood, Roveri laccati opachi, Laccati opachi e lucidi, Laccati micalizzati.

These bedside tables, dressers and chests of drawers with well-proportioned, linear lines feature a "chain" groove that makes for easy opening. This recess is particularly characteristic in the models featuring a contrasting colour.

Materials and finishes

Frame: Fashion Wood, matt lacquered oak, matt and high-gloss lacquer, micalised lacquer.

Gruppo letto / Bedroom suite

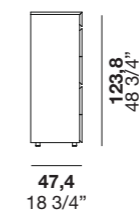
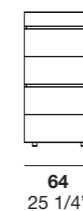
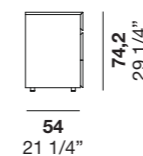
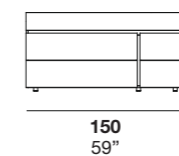
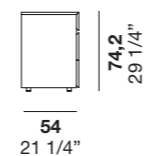
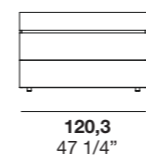
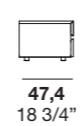
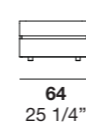

DISCO

design R&D Alf DaFrè



Specchiera Disco con cornice in metallo finitura Moka Shine. Disponibile in tre misure.

Disco mirror with metal frame in Moka Shine finish. Available in three sizes.

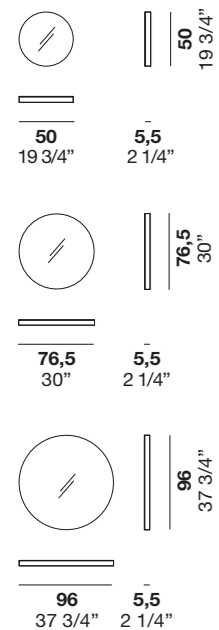

ESAGONA

design R&D Alf DaFrè



Specchiera Esagona, adatta ad ogni ambiente, ha cornice in metallo finitura Moka Shine.

The Esagona mirror, suitable for any space, has a metal frame finished in Moka Shine.

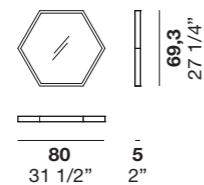

FIL

design R&D Alf DaFrè



Le specchiere Fil sono dotate di una cornice in metallo di forte spessore. Disponibili in una vasta gamma di misure e finiture cornice.

The Fil mirrors have a thick metal frame. Available in a wide range of frame sizes and finishes.

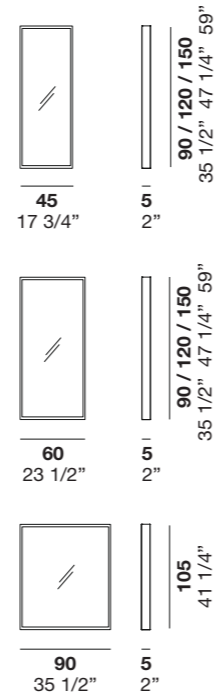

HAIKU

design Bruna Vaccher



Haiku è una specchiera "a terra" che nasconde pratiche funzioni, come l'appendino e il comodo ripiano disponibile in una vasta gamma di finiture.

Haiku is a floor-standing mirror unit with hidden practical features like a clothes rail and handy shelf available in a wide range of finishes.

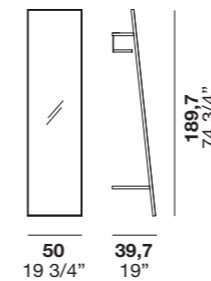

HAIKU

design Bruna Vaccher



Haiku servomuto è un sistema semplice per riporre gli abiti velocemente, alloggiare gli accessori che ci accompagnano durante la giornata, mantenere in ordine la stanza da letto.

The Haiku clothes stand provides a quick and simple way to put away clothes, tidy the accessories we use during the day, and keep the bedroom space tidy.

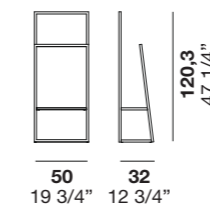

RELIEF

design Bruna Vaccher



Tappeto Relief: le proprietà brillanti della viscosa di bamboo sono utilizzate al meglio in questo esercizio di tessitura manuale contemporanea. Il volume di questa tessitura, ottenuto dai telai antichi ancora disponibili in India, risulta essere compatto, seducente e vibrante alla luce.

Relief rug: this contemporary hand-woven piece boasts a shiny finish created by the bamboo viscose material. The weave was created using ancient looms still found in India and is both compact and seductive, glimmering in the light.

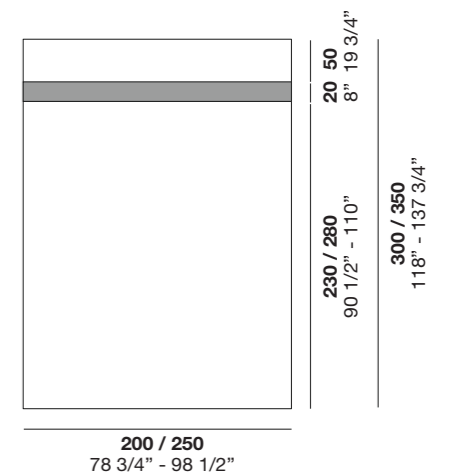

^{IT} Design, personalizzazione, ricerca green, sono i pensieri chiave del lavoro di ricerca e sviluppo dei nuovi prodotti pensati per arredare la zona notte. Alf DaFrè, ha definito i temi indispensabili del nuovo progettare l'arredo contemporaneo. Materiali ecologici, linea produttiva rispettosa dell'ambiente, design ricercato, non solo estetico, ma attento alla funzionalità dei nuovi stili dell'abitare contemporaneo.

^{EN} Design, customisation and environmental sustainability: these are the key concepts fuelling the R&D work behind the new bedroom products. Alf DaFrè has clearly set out the fundamentals on its new path for contemporary furniture design: ecological materials, environmentally friendly production and elegant designs that are attentive to the functionality of new contemporary living styles, as well as the aesthetics.

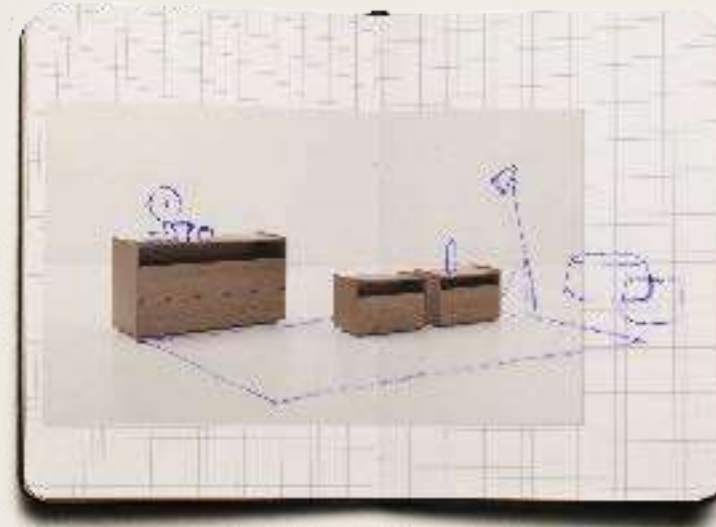

02 → Prototipo Ray
Ray prototype



01 → Ricerca nuove forme e finiture
Research into new shapes and finishes



03 → Linea produzione
Production line



04 → Magazzino prodotti finiti
Finished product warehouse



IT Alf DaFrè è orgogliosa di raccontare tutta l'evoluzione nella ricerca e sviluppo dei propri prodotti, sempre attenta alle risposte da dare alle continue richieste del mercato. Una ricerca che ha lavorato sia sui materiali che sui metodi di produzione, pensati nell'ottica di favorire il processo di cambiamento ecologico in atto.

EN Alf DaFrè is proud to present the full evolution of its product designs: the result of attentive research and development work in response to the ongoing demands of the market. This work is focused on both materials and production methods, with a view to promoting the ecological transition underway.

Alf DaFre®

A.L.F. Uno SpA
Via S. Pio X 17
31018 Francenigo di Gaiarine
Treviso, Italy
Tel. +39 0438 997111
Fax Italia +39 0438 997245
Fax estero +39 0438 997246
www.alfdafre.it alf@alf.it



A.L.F. Uno SpA
è certificata ISO 9001:2015
A.L.F. Uno SpA
is certified by the ISO 9001:2015

Verifica le finiture disponibili sul nostro sito internet / Check the finishes available on our website www.alfdafre.it

A.L.F. Uno SpA si riserva di apportare in qualsiasi momento modifiche a prodotti, misure e materiali, che ritenesse utili per esigenze di carattere produttivo e commerciale. Per essere sempre aggiornati vi invitiamo a consultare il nostro sito internet www.alfdafre.it. LE FINITURE: I materiali utilizzati dalla nostra azienda sono selezionati tra i più affidabili per applicazione e resa estetica. Nonostante questo devono considerarsi tollerabili alcune differenze dovute alle caratteristiche stesse di materiali come essenze naturali, vetri, laccature e all'artigianalità di alcune fasi del processo produttivo che da sempre è un nostro valore aggiunto. Inoltre alcune finiture possono subire nel tempo maturazioni dovute all'azione della luce e del tempo. È importante quindi specificare se nell'ordine vi sono sostituzioni o completamenti per valutare insieme il miglior modo di procedere. Le tonalità di colore e le finiture illustrate vanno considerate puramente indicative. Verificare sempre la fattibilità dell'abbinamento finiture consultando l'interno del listino.

A.L.F. Uno SpA reserves the right to make any changes to products, measurements and materials at any time deemed useful for manufacturing and sales purposes. To stay up to date at all times, please visit our website www.alfdafre.it. FINISHES: The materials we use are selected among the most reliable products in terms of application and aesthetic rendering. Despite this, certain differences due to the very characteristics of materials such as natural wood finishes, glass and lacquers must be considered tolerable, as well as the hand-crafted nature of certain phases of the production process, which has always been one of our added values. In addition, some finishes may change over time, due to the effects of light and time. It is therefore important to specify whether there are replacements or completions in the order to assess the best way to proceed together. The finishes featured in this sample collection are purely indicative and are not available for all products. Please check in the price list if the finish is available for the chosen item. Orders will not be accepted for products with finishes not included in the price list. The colour shades and finishes illustrated herein are to be considered purely indicative. Always check the feasibility of finish combinations by consulting the price list contents.

