

**DIVANI / SOFAS**  
**TAVOLINI / OCCASIONAL TABLES**  
**POLTRONE / ARMCHAIRS**



**Alf DaFre®**

**DIVANI / SOFAS**  
**TAVOLINI / OCCASIONAL TABLES**  
**POLTRONE / ARMCHAIRS**

**Alf DaFre®**

# Index

## Divani / Sofas



SOBI  
pag. 006



LAND  
pag. 022



CALIFORNIA  
pag. 042



COPENAGHEN  
pag. 070



OSLO 2  
pag. 088



LADIGUE  
pag. 096



NEVADA  
pag. 108

## Poltrone / Armchairs



SOBI  
pag. 006



RAKU  
pag. 124



OLIVIA  
pag. 134



LISA  
pag. 142



DENNY  
pag. 146



NOBU  
pag. 152

## Tavolini / Occasional tables



TSUKI  
pag. 160



NEYO  
pag. 164



MALMO  
pag. 168



KOBE / HANDY KOBE  
pag. 174



LIFE  
pag. 182



MOCA  
pag. 186



TUFT  
pag. 190



WOK  
pag. 198



NORMAN  
pag. 202

## Tappeti / Rugs



RELIEF  
pag. 206

<sup>IT</sup> Eleganza raffinata, comfort che dura nel tempo, capacità di inserirsi in ogni ambiente, per una collezione di divani e poltrone che uniscono l'eccellenza della migliore manifattura italiana, con le ispirazioni del mondo del design contemporaneo: in una sintesi unica, con una scelta infinita di soluzioni, colori, sensazioni.

<sup>EN</sup> Stylish elegance, long-lasting comfort, fit for any space: this collection of sofas and armchairs combines outstanding Italian manufacturing with inspiration from the world of contemporary design. The unique end result offers an infinite choice of colours, designs and looks.

- 006 Sobi
- 022 Land
- 042 California
- 070 Copenaghen
- 088 Oslo 2
- 096 Ladigue
- 108 Nevada



# Sobi

Sobi è un famiglia di imbottiti dalle forme soffici e organiche, disegnate con curve sinuose che invitano al relax e al piacere di vivere. Divani e poltrone sono configurabili con cuscini schienale e pouf, per aggiungere un'ulteriore dimensione al comfort.

Sobi is a range of upholstered furniture with soft, organic shapes, and sinuous curves that ooze relaxation and good living. Sofas and armchairs can be configured with cushions and footstools for added comfort.

design Gordon Guillaumier





**Gioberg credenza / sideboard**  
Laccato micalizzato Nickel e Laccato  
Modica lucido / Micalised Nickel lacquer  
and High gloss Modica lacquer  
L/W200,2 P/D51,8 H 78,3

**Tsuki tavolino / occasional table**  
Struttura verniciato moka shine,  
Piano vetro bronzo satinato / Structure  
painted in Moka Shine /  
Satin-finish bronze glass top  
L/W104,5 P/D76,8 H35

**Sobi divano / sofa**  
Tessuto Ricciolone 01/2 / Ricciolone 01/2  
fabric  
L/W244 P/D145 H89,5

**Sobi pouf**  
Tessuto Ricciolone 01/2 / Ricciolone 01/2  
fabric  
L/W80 P/D75 H39

**Sobi poltrona / armchair**  
Tessuto Ricciolone 01/2 / Ricciolone 01/2  
fabric  
L/W87 P/D85 H71





**Sobi divano / sofa**  
Tessuto Made F19 / Made F19 fabric  
L/W258 P/D91 H89,5

**Sobi poltrona / armchair**  
Tessuto Made F19 / Made F19 fabric  
L/W87 P/D85 H71

**Tsuki tavolini / occasional tables**  
Struttura verniciato Moka Shine, piano  
vetro Bronzo satinato / Structure painted in  
Moka Shine, Satin-finish bronze glass top  
L/W101,7 P/D99,8 H28  
L/W104,5 P/D76,8 H35  
L/W60 P/D54,3 H42



**Sobi divano / sofa**  
 Tessuto Made F19 / Made F19 fabric  
 L/W258 P/D91 H89,5

**Sobi poltrona / armchair**  
 Tessuto Made F19 / Made F19 fabric  
 L/W87 P/D85 H71

**Tsuki tavolini / occasional tables**  
 Struttura verniciato moka shine e piano  
 vetro bronzo satinato/ Structure painted in  
 Moka Shine and satin-finish bronze glass top  
 L/W101,7 P/D99,8 H28  
 L/W104,5 P/D76,8 H35  
 L/W60 P/D54,3 H42





Recta credenza / sideboard  
Laccato Fango lucido / High gloss Fango lacquer  
L/W200,2 P/D51,8 H78,3



**Sobi** poltrona / armchair  
Tessuto Ricciolone 01/2 / Ricciolone 01/2  
fabric  
L/W87 P/D87 H96

**Tsuki** tavolino / occasional table  
Struttura verniciato Moka Shine, piano  
vetro Bronzo satinato / Structure painted in  
Moka Shine, Satin-finish bronze glass top  
L/W60 P/D54,3 H42



Sobi è una variegata collezione di imbottiti composta da divani, chaise longue singola, poltrona e pouf. Continuando nella ricerca, già intrapresa con la collezione Raku, verso una dimensione sofisticata e domestica del comfort. Sobi ha volumi consistenti e forme morbide e organiche.

Sobi is a diverse collection of upholstered furniture made up of sofas, a single chaise longue, an armchair and a footstool. The collection represents a continuation of the journey, which began with the Raku collection, to create a sophisticated yet homely dimension of comfort. Sobi is substantial in size and has soft, organic shapes.

Materiali e finiture  
Rivestimento: Tessuti, Pelle.

Materials and finishes  
Covering: Fabric, Leather.

## Poltrona con piedini / Armchair with feet

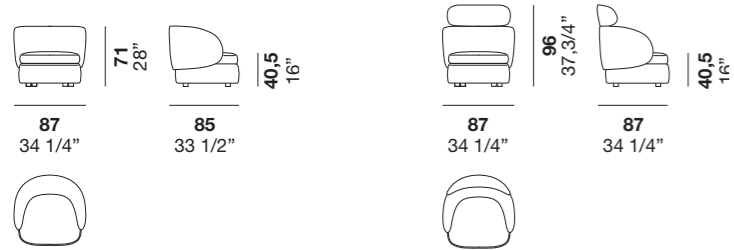

## Poltrona con basamento girevole / Armchair with swivel base

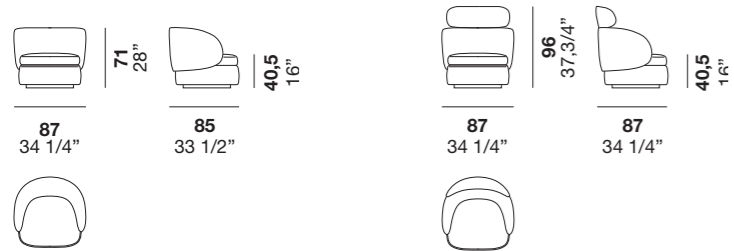

## Pouf

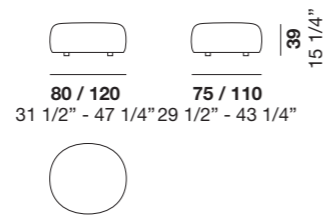

## Divani / Sofa

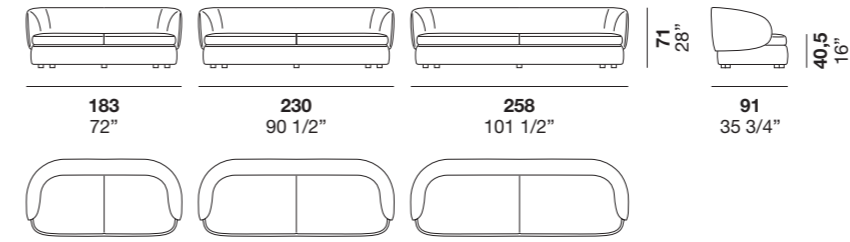

## Divano con penisola / Sofa with lounge end unit

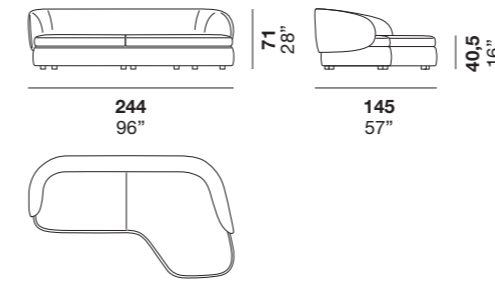

## Divani con cuscini L60 cm / Sofas with cushions W. 60 cm

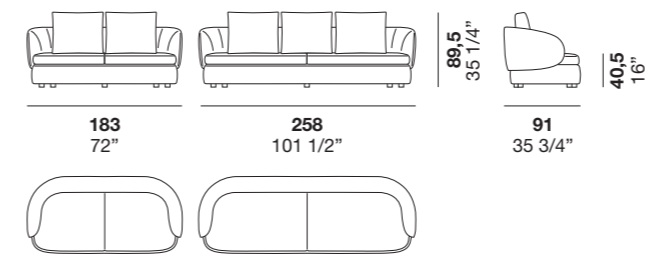

## Divani con cuscini L70 cm / Sofas with cushions W. 70 cm

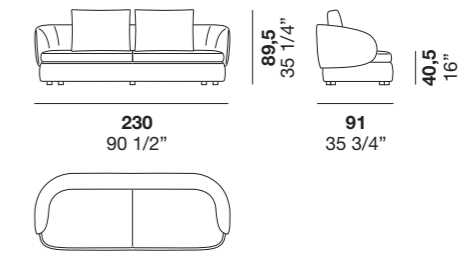

## Divano con cuscini L70 cm e penisola / Sofa with cushions W. 70 cm and lounge end unit

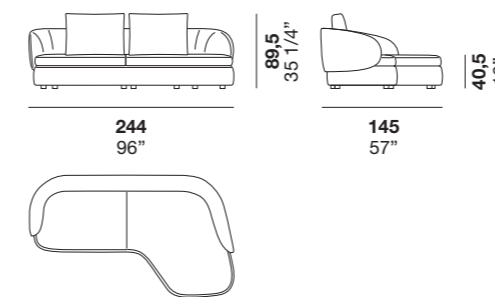

## Divani con cuscini L80 cm / Sofas with cushions W. 80 cm

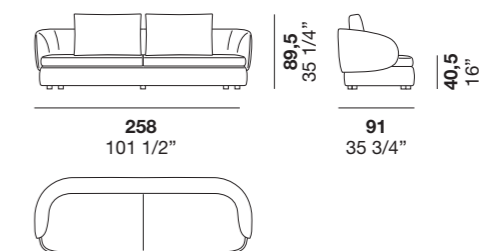

# Land

Modularità, libertà compositiva e comfort sono i concetti guida di Land, un sistema che permette di realizzare infinite composizioni, scegliendo fra due larghezze di seduta: 110 cm e 85 cm per creare la soluzione più in sintonia con il proprio spazio e i propri desideri.

Free, modular relaxation: this is the guiding concept for Land. This range allows you to create infinite compositions, with units available in two widths: maxi, 110 cm, and mini, 85 cm, for solutions that are in tune with your space and needs.

design Enrico Cesana





Land divano / sofa  
Tessuto Nodone A1304 e tavolini in laccato  
fango lucido/ Nodone A1304 fabric and  
high gloss Fango lacquer occasional tables  
L/W430 P/D490 H101

Tsuki tavolini / occasional tables  
Struttura verniciato moka shine e piano  
vetro bronzo satinato/ Structure painted  
in Moka Shine and satin-finish bronze  
glass top

L/W101,7 P/D99,8 H28  
L/W104,5 P/D76,8 H35  
L/W60 P/D54,3 H42





**Raku** poltrona / armchair  
Tessuto Made F19 / Made F19 fabric  
L/W84 P/D69 H75

**Nobu** pouf  
Tessuto Senky unito 006 / Senky unito  
006 fabric  
L/W36,8 P/D42,6 H44

**Land** divano / sofa  
Cuscini Tessuto Senky unito 002, basi pelle  
Lord 9340 e tavolini Fashion wood Rovere  
Canapa / Senky plain 002 fabric pillows,

Lord 9340 leather bases and Fashion wood  
Canapa oak occasional tables  
L/W540 P/D270 H101

**Moca** tavolino / occasional table  
Nero opaco / Matte black  
L/W60 P/D60 H45,4

**Kobe** tavolino / occasional table  
Nero opaco / Matte black  
L/W120 P/D70 H33

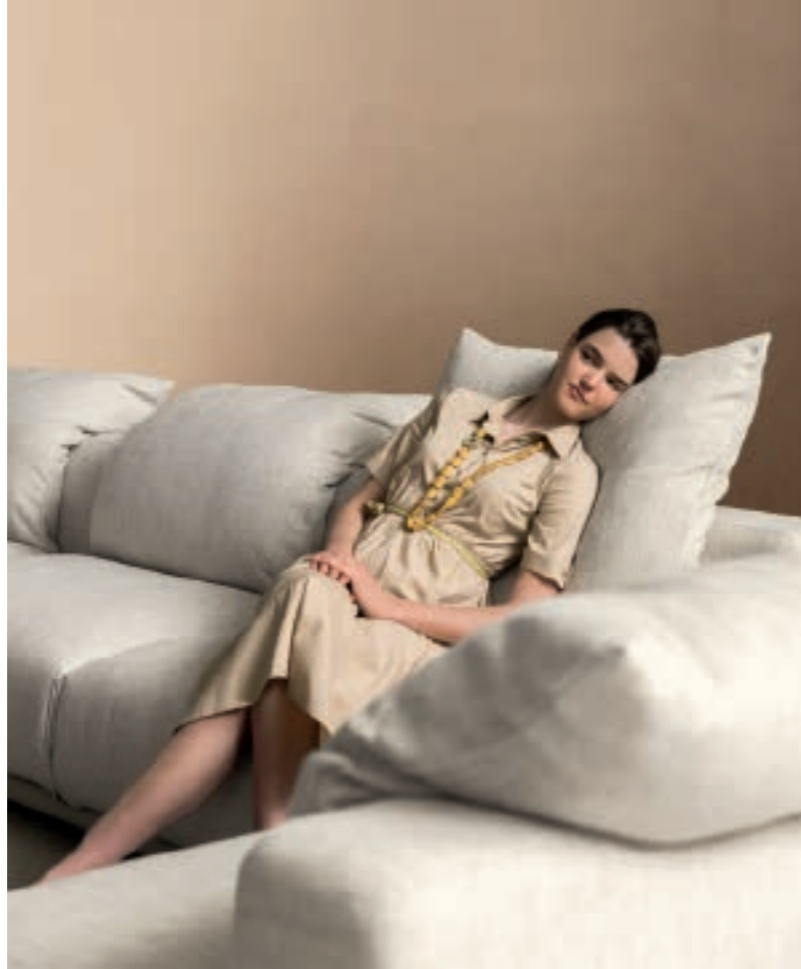

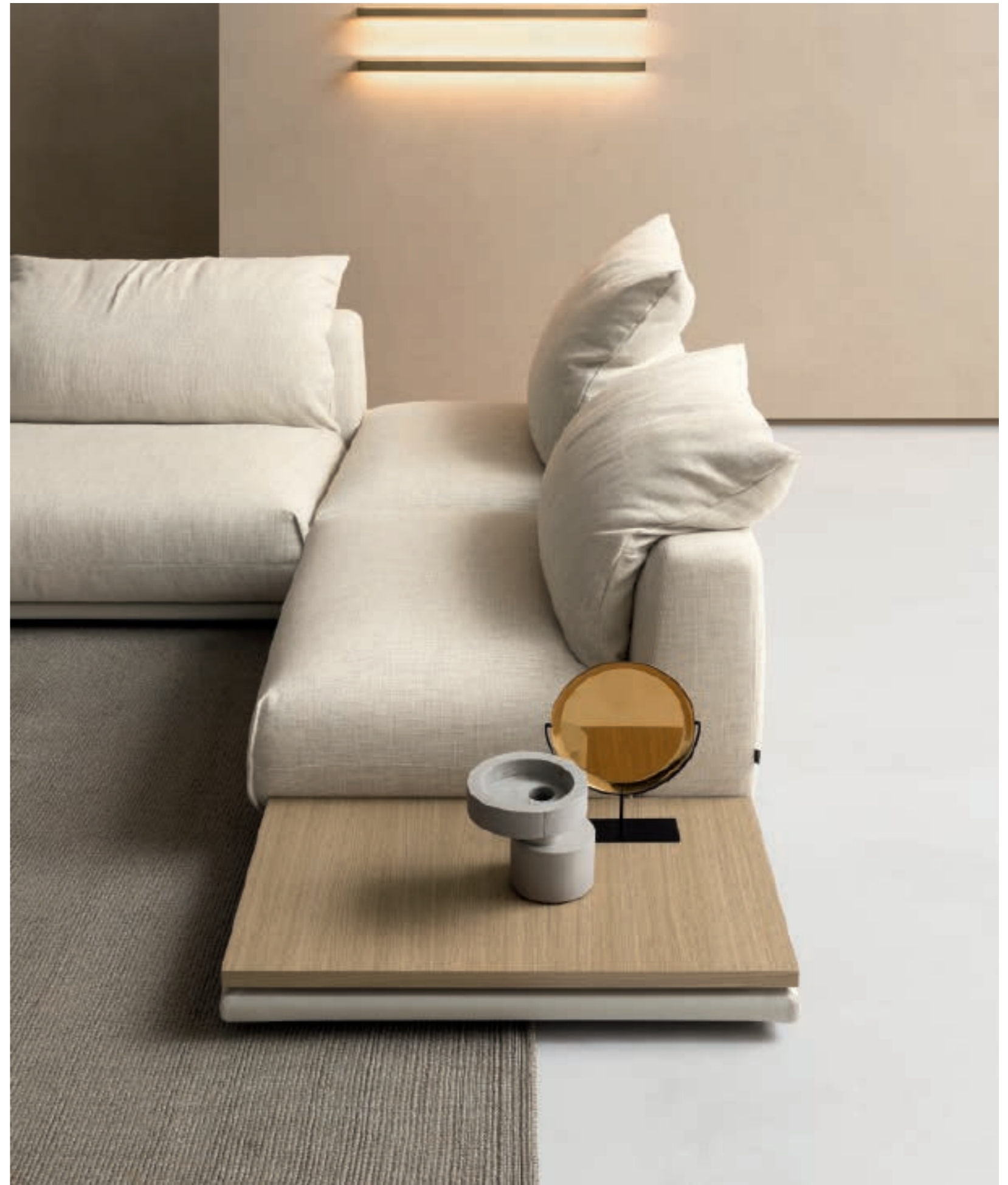



**Denny pouf**  
 Ecopelle Time 800 / Ecopelle Time 800  
 L/W85 P/D85 H37

**Denny pouf**  
 Tessuto Nina 37 / Nina 37 fabric  
 L/W55 P/D55 H42

**Norman tavolino / occasional table**  
 Fashion wood Rovere Carbone /  
 Fashion wood Carbone oak  
 L/W100 P/D100 H33,6

**Metropolis madia / cabinet**  
 Fashion wood naturale / Natural fashion  
 wood  
 L/W128 P/D52,2 H136

**Land divano / sofa**  
 Tessuto Please 104 / Please 104 fabric  
 L/W270 P/D100 H101  
 L/W270 P/D100 H101

**Tuft tavolino / occasional table**  
 Nero opaco / Matte black  
 L/W40,3 P/D40,3 H46,3  
 L/W60,3 P/D60,3 H36,8

**Kobe tavolino / occasional table**  
 Nero opaco / Matte black  
 L/W120 P/D70 H33



# LAND

design Enrico Cesana

Il concept di Land si basa sull'idea di un semplice basamento che accoglie i cuscini seduta/schienale e confortevoli cuscini da appoggio aggiuntivi. La particolarità, oltre alla grande flessibilità data dalla larghezza di seduta in due dimensioni, è la possibilità di sostituire la seduta imbottita con un funzionale piano di appoggio che aggiunge movimento alla continuità della composizione.

The concept for Land is based on the idea of a simple base that contains the seat/back cushions and other comfy cushions. Its unique feature – apart from its flexibility with a wide seat in two sizes – is that the padded seat can be replaced with a practical surface, adding movement to the continuous design of the composition.

## Materiali e finiture

Rivestimento: Tessuti, Pelle.  
Tavolini: Fashion wood, Roveri laccati opachi, Laccati opachi e lucidi, Laccati micalizzati.

## Materials and finishes

Covering: Fabric, Leather.  
Occasional tables: Fashion wood, Oak matt colours, Matt and high gloss lacquers, Micalised lacquers.

### Divani / Sofas

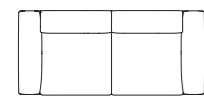
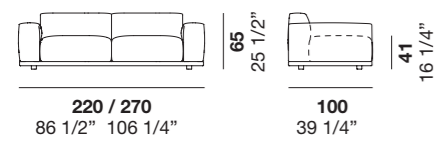

### Moduli terminali / End units

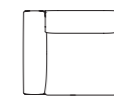
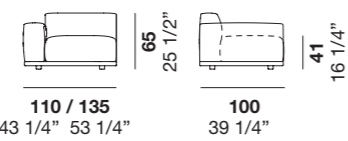

### Chaise longue

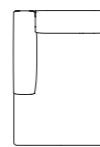
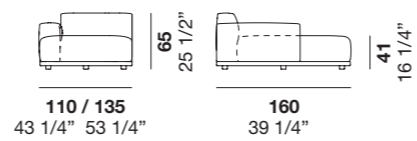

### Angoli / Corner units

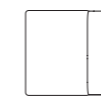
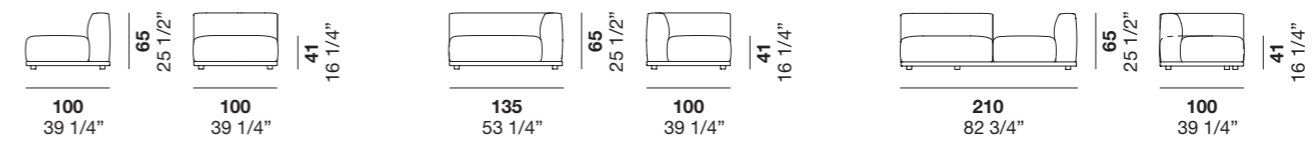

### Moduli centrali / Central units

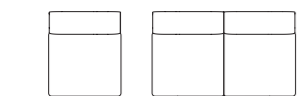
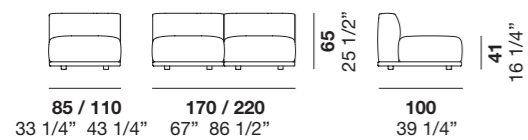

### Moduli con pouf / Units with footstool

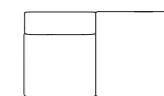
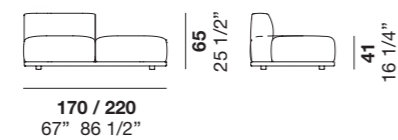

### Pouf

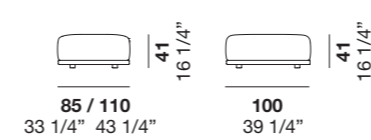

### Moduli con tavoli / Units with tables

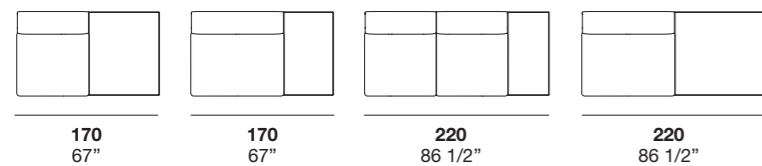
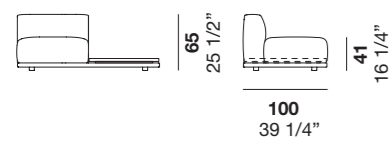

# California

California è un progetto in evoluzione, arricchitosi nel tempo di nuovi elementi che lo rendono originale e versatile, senza rinunciare al fascino dell'essenzialità.

California is an evolving range that has been added to over time. New features keep the designs original and versatile, without compromising on its minimalist feel.

design Enrico Cesana





**California** divano / sofa  
Tessuto Regal E008 / Regal E008 fabric  
**California** tavolini / occasional tables  
Fashion wood Revere Terra / Fashion wood  
Terra oak  
L/W400 P/D158 H84

**Tsuki** tavolini / occasional tables  
Struttura verniciato moka shine e piano  
vetro bronzo satinato / Structure painted  
in Moka Shine and satin-finish bronze  
glass top  
L/W101,7 P/D99,8 H28





**Lisa poltrona / armchair**  
 Tessuto Iris 406 / Iris 406 fabric  
 L/W89 P/D94,5 H92

**Denny pouf**  
 Tessuto Nina 37 / Nina 37 fabric  
 L/W55 P/D55 H42

**Wok tavolini / occasional tables**  
 Laccato opaco Amaranto / Amaranto matte  
 lacquer  
 L/W27,5 P/D27,5 H50

**Wok tavolini / occasional tables**  
 Laccato opaco Tortora / Matte lacquer  
 Tortora  
 L/W27,5 P/D27,5 H50

**Diko madia / cabinet**  
 Laccato opaco Amaranto e basamento  
 Moka shine/ Amaranto matte lacquer and  
 Moka shine basement  
 L/W98,8 P/D45,7 H147

**California divano / sofa**  
 Tessuto Made F14 / Made F14 fabric  
**California tavolini / occasional tables**  
 Fashion wood Rovere Ghiro / Fashion  
 wood Ghiro oak  
 L/W581 P/D252 H84

**Rim tavolini / occasional tables**  
 Fashion wood Canapa e laccato opaco  
 Tortora / Fashion wood Canapa and matte  
 lacquer Tortora  
 L/W40 P/D40 H52







**Raku** poltrona e pouf / armchair and pouf  
Tessuto Nina 31 / Nina 31 fabric  
L/W83 P/D66 H73



**California** divano / sofa  
Tessuto Fado 26 / Fado 26 fabric  
L/W356 P/D125 H84

**Moca** tavolino / occasional table  
Struttura laccato Nero opaco, piano laccato  
micalizzato Oro / Structure in matt Nero  
lacquered, Top in Micalyzed Oro laquered  
L/W60 P/D60 H45,4

**Wok** tavolino / occasional table  
Laccato Nero opaco / Matt Nero lacquered  
L/W27,5 P/D27,5 H50



**California** divano / sofa  
Pelle Lord 9120 / 9120 Lord leather  
L/W401,3 P/D147,2 H84

**Moca** tavolino / occasional table  
Struttura laccato Nero opaco, piano  
Fashion wood rovere Fossile, laccato Nero  
opaco / Structure in matt Nero lacquered,  
Top in Fashion wood Fossile oak, matt Nero  
lacquered  
L/W60 P/D60 H45,4 L/W90 P/D90 H37

**Wok** tavolino / occasional table  
Laccato Nero opaco / Matt Nero lacquered  
L/W27,5 P/D27,5 H50

**Denny** pouf  
Pelle Lord 9120 / 9120 Lord leather  
L/W85 P/D85 H37





**California divano / sofa**  
Tessuto Taiga 01 colore 90-1 / Taiga 01  
color 90-1 fabric  
sx L/W171 P/D158 H84  
dx L/W326 P/D361 H84

**California tavolino / occasional table**  
Fashion wood rovere Ghiro e laccato opaco  
Tortora / Fashion wood Ghiro oak and  
matte lacquer Tortora

**Tsuki tavolino / occasional table**  
Struttura verniciato moka shine e piano vetro  
bronzo satinato / Structure painted in Moka  
Shine and satin-finish bronze glass top  
L/W104,5 P/D76,8 H35  
L/W60 P/D54,3 H42







# CALIFORNIA

design Enrico Cesana

Il divano California si arricchisce con penisole e moduli che escono dalla logica dell'ortogonalità e creano sedute conviviali e adatte a un'idea di living meno schematica e formale, invece più aperta e accogliente.

The California sofa features lounge end units and modules that go beyond the idea of square right angles. They create convivial seating arrangements suitable for a less schematic and formal idea of a living room that is more open and welcoming.

## Materiali e finiture

Rivestimento: Tessuti, Pelle, Ecopelle.  
Tavolini: Fashion wood, Roveri laccati opachi, Laccati opachi e lucidi, Laccati micalizzati.

## Materials and finishes

Covering: Fabric, Leather, Ecoleather.  
Occasional tables: Fashion wood, Oak matt colours, Matt and high gloss lacquers, Micalised lacquers.

## Divani / Sofas

## Moduli centrali / Central units

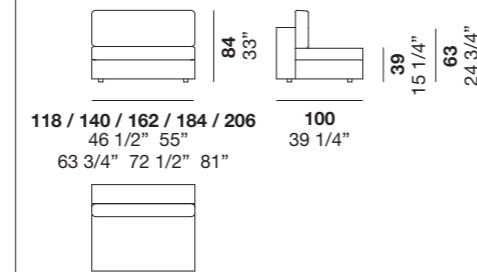
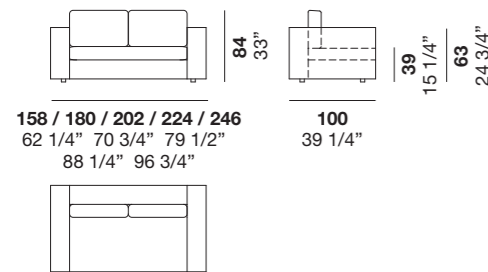

## Penisole terminali sx o dx / LH or RH end lounge units

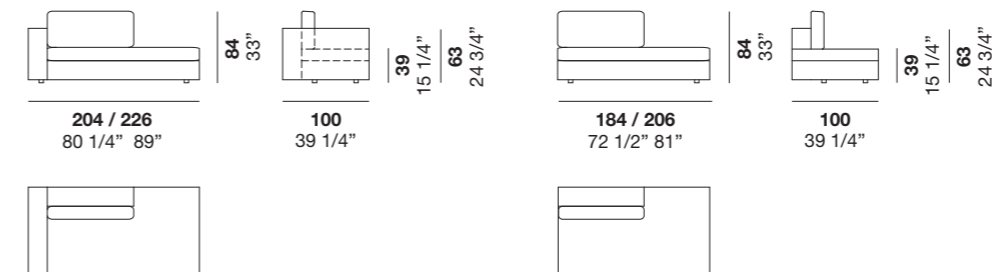

## Moduli terminali sx o dx / LH or RH end units

## Angolo / Corner unit

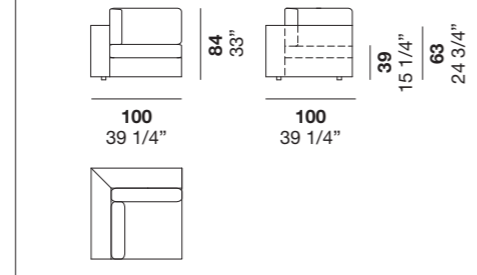
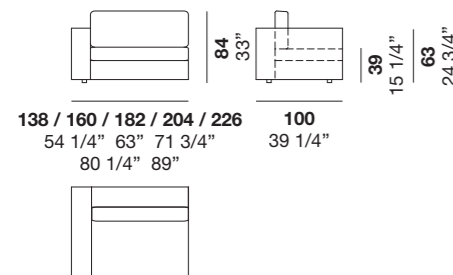

## Moduli penisola inclinata sx o dx / LH or RH angled lounge units

## Moduli terminali inclinati sx o dx / LF or RF angled end units

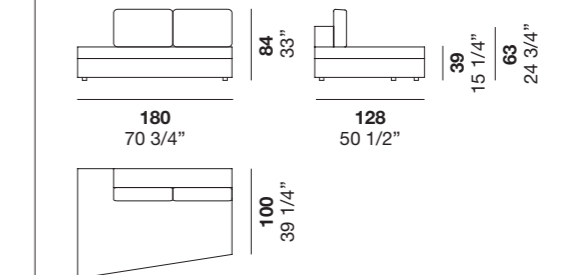
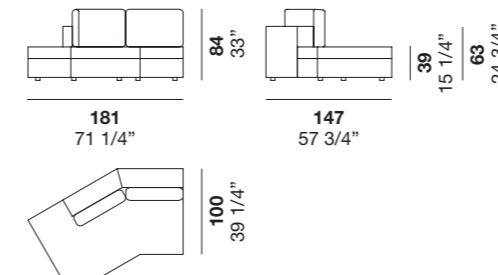

## Chaise longue sx o dx / LH or RH chaise longue

## Pouf

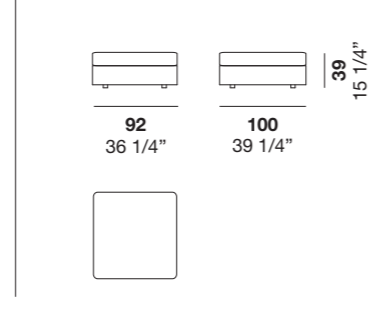
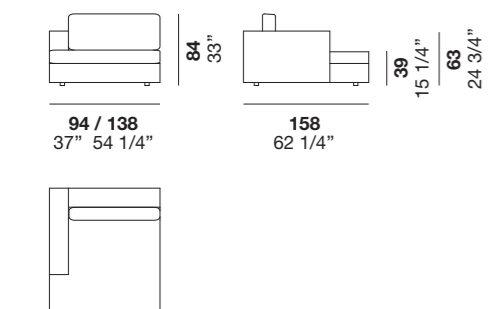

## Tavolini / Occasional tables

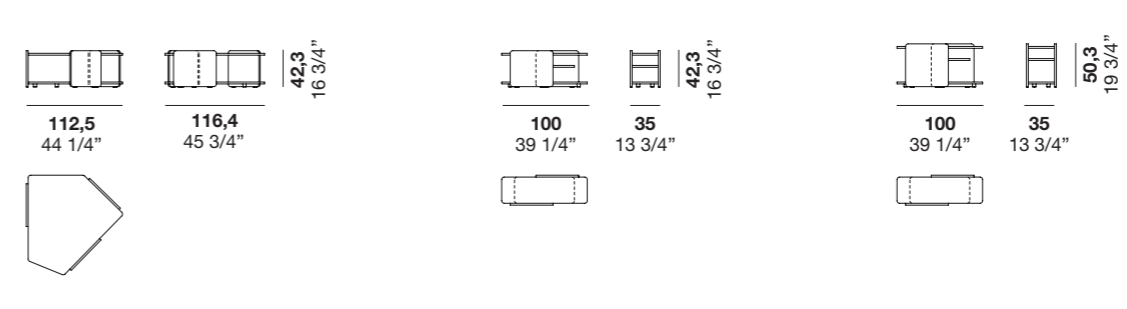

# Copenaghen

Concepito per la casa contemporanea, Copenaghen è progettato con un nuovo sistema di imbottiture per offrire leggerezza estetica, armonia e comfort, in grado di soddisfare ogni desiderio e di inserirsi con versatilità in qualsiasi spazio giorno, anche grazie alla possibilità di scegliere fra due profondità diverse.

Designed for the contemporary home, Copenaghen offers light, harmonious comfort to satisfy your every need. Versatile in its conception, it adapts to any living space, and is also available in two depths.

design Enrico Cesana







**Copenaghen divano / sofa**  
Tessuto Rubens 06 / Rubens 06 fabric  
L/W390 P/D110 H86

**Raku divanetto / sofa**  
Tessuto Regal E044 / Regal E044 fabric  
L/W158 P/D66 H73



**Copenaghen divano / sofa**  
Tessuto Antibes 513 /  
Antibes 513 fabric  
L/W255 P/D90 H86

**Malmo tavolino / occasional table**  
Struttura Moka Shine, Piano Fashion wood  
rovere Naturale / Structure in Moka Shine,  
Top in Fashion wood Naturale oak  
L/W42 P/D42 H50

**Malmo tavolino / occasional table**  
Struttura Moka Shine, Piano Fashion wood  
rovere Ghirò / Structure in Moka Shine, Top  
in Fashion wood Ghirò oak  
L/W100 P/D100 H41,3

**Malmo tavolino / occasional table**  
Struttura Laccato opaco Tè verde, Piano  
Rovere colore opaco Tè verde / Structure in  
Matt lacquered Tè verde, Top in Matt oak  
colour Tè verde  
L/W150 P/D50 H54,2



**Musa credenza / sideboard**  
Fashion wood Rovere Fossile / Fashion wood Fossile oak  
L/W220 P/D52,7 H75

**Denny pouf**  
Tessuto Fado 11 / Fado 11 fabric  
L/W142 P/D55 H42

**Tsuki tavolino / occasional table**  
Struttura verniciato moka shine e piano vetro bronzo satinato / Structure painted in Moka Shine and satin-finish bronze glass top  
L/W104,5 P/D76,8 H35 L/W60 P/D54,3 H42

**Copenaghen divano / sofa**  
Tessuto Fado 11 / Fado 11 fabric  
L/W260 P/D110 H86

**Copenaghen divano / sofa**  
Tessuto Regal E060 / Regal E060 fabric  
L/W340 P/D160 H86

**Nobu pouf**  
Tessuto Senky unito 006 / Senky unito 006 fabric  
L/W38,6 P/D42,6 H44



Il piede di Copenaghen con terminale in Rovere Carbone lo arricchisce di stile attraverso la combinazione di legno e metallo. Disponibile anche nella versione Rovere Naturale. / The Copenaghen foot has a Carbone oak end to add style by combining wood and metal. Also available in Naturale oak.





**Da-Do giorno** porta TV / TV base  
Struttura esterna laccato Platino opaco,  
top e gola Laccato Modica opaco / External  
structure in matt Platino lacquered, top and  
groove in matt Modica lacquered  
L/W234,8 P/D47 H56

**Copenaghen** divano / sofa  
Tessuto Senky unito 006 / Senky unito 006  
fabric  
L/W215 P/D310 H75

**Shift** sedia / chair  
Struttura Fashion wood Rovere Fossile,  
seduta e schienale tessuto St. Moritz 133 /  
Structure in Fossile oak Fashion wood, seat  
and back in St. Moritz 133 fabric  
L/W49 P/D54,7 H76,8

**Kobe** tavolino / occasional table  
Struttura verniciato nero trasparente  
lucido, piano in Laminam Fokos Sale  
Limestone ash / Structure in gloss  
transparent black painted, top in  
Limestone ash Laminam Fokos Sale  
L/W120 P/D70 H33





**Malmo tavolino / occasional table**  
 Struttura laccato Amaranto opaco, piano  
 laccato Amaranto lucido /  
 Structure in matt Amaranto lacquered, top  
 in gloss Amaranto lacquered  
 L/W42 P/D42 H50

**Copenaghen divano / sofa**  
 Tessuto Fado 28 / Fado 28 fabric  
 L/W325 P/D160 H86

**Malmo tavolino / occasional table**  
 Struttura laccato Amaranto opaco, piano  
 Fashion wood Rovere Carbone /  
 Structure in matt Amaranto lacquered, top  
 in Carbone oak Fashion wood  
 L/W100 P/D100 H41,3

**Malmo tavolino / occasional table**  
 Struttura laccato Moka Shine opaco, piano  
 Rovere colore opaco Modica /  
 Structure in matt Moka Shine lacquered,  
 top in matt Modica lacquered oak  
 L/W150 P/D50 H54,2

# COPENAGHEN

design Enrico Cesana

In aggiunta alle diverse varianti in catalogo, il divano Copenaghen è presentato oggi con una nuova profondità di 110 cm pensata per offrire una seduta più confortevole e idonea al relax in tutte le ore del giorno.

In addition to the different varieties in the catalogue, the Copenaghen sofa now comes in a new depth of 110 cm designed to provide a more comfortable seat suitable for relaxing at all times of the day.

Materiali e finiture  
Rivestimento: Tessuti, Pelle, Ecopelle.

Materials and finishes  
Covering: Fabric, Leather, Ecoleather.

## Divani con cuscini schienale / Sofas with backrest cushions

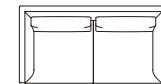
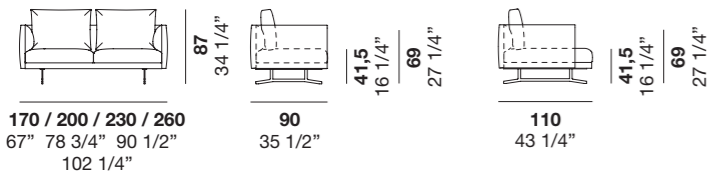

## Moduli terminali con cuscini schienale / End units with backrest cushions

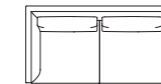
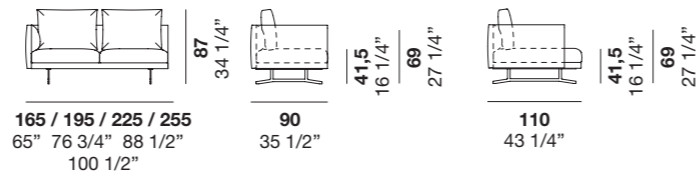

## Divani con cuscini decorativi con fascia / Sofas with decorative cushions with band

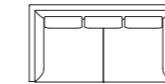
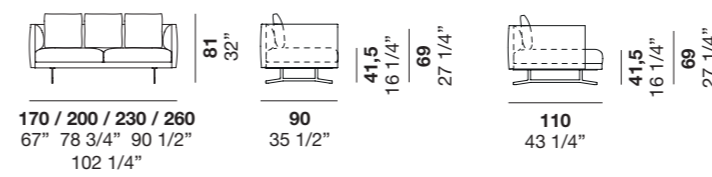

## Moduli terminali con cuscini decorativi con fascia / End units with decorative cushions with band

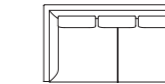
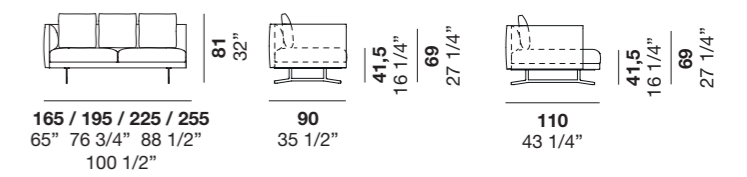

## Moduli centrali con cuscini schienale / Central units with backrest cushions

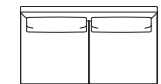
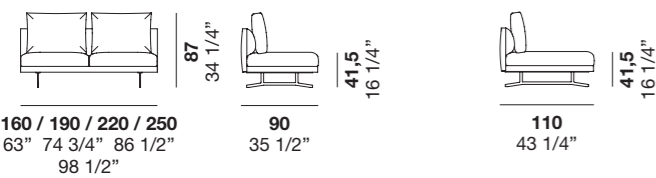

## Moduli chaise longue con cuscini schienale / Chaise longue units with cushions schienale

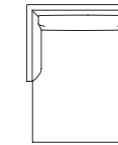
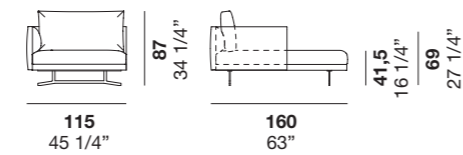

## Moduli centrali con cuscini decorativi con fascia / Central units with decorative cushions with band

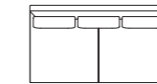
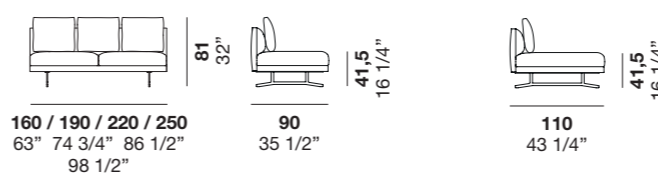

## Moduli chaise longue con cuscini decorativi con fascia / Chaise longue units with decorative cushions with band

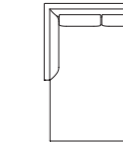
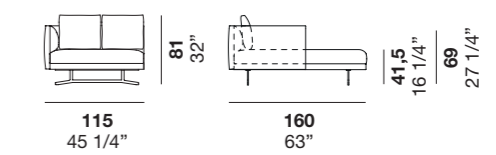

## Moduli penisola con cuscini schienale / Peninsula units with backrest cushions

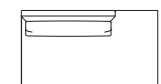
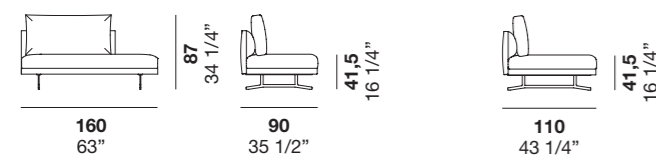

## Pouf

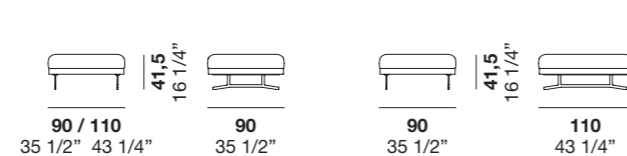

## Moduli penisola con cuscini decorativi con fascia / Peninsula units with decorative cushions with band

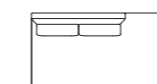
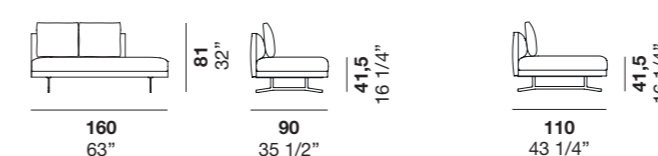

## Piedini disponibili / Available feet

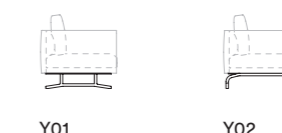

# Oslo 2

Grandi e morbidi cuscini sono appoggiati su una base dalle linee essenziali, sospesa su sottili piedini in metallo verniciato: è questa la personalità estetica del divano Oslo 2, disponibile in diverse larghezze e con due varianti di poltrona, per comporre il proprio ambiente living ideale.

Large, soft cushions rest on a sleek base, which stands on slender painted metal feet: the Oslo 2 sofa has real aesthetic clout. Create your ideal living space. Available in different widths and with two armchair models.

design Enrico Cesana



Il piede di Oslo 2 in Moka shine con terminale in Rovere Carbone. Un dettaglio di design che combina legno e metallo per caratterizzare questo divano in modo unico. Disponibile anche nella versione Rovere Naturale. / Oslo 2 foot detail in Moka Shine with Carbone oak end. This design element combines wood and metal, to give the sofa a unique look. Also available in Naturale oak.



**Oslo 2** divano / sofa  
Tessuto Ranger 25 / Ranger 25 fabric  
L/W260 P/D92 H83

**Oslo 2** poltrona / poltrona  
Tessuto Fenkè unito 701 / Fenkè unito  
701 fabric  
L/W80 P/D92 H83

**Norman** tavolino / occasional table  
Laccato Arena opaco / Arena matte  
lacquer  
L/W100 P/D100 H33,6



**Malmo tavolini / occasional tables**  
Laccato Oroigano lucido / Matt  
Origano lacquer  
L/W100 P/D100 H41,3

**Malmo tavolini / occasional tables**  
Laccato Juta opaco / Matt Juta lacquer  
L/W42 P/D42 H50

**Malmo tavolini / occasional tables**  
Fashion wood Rovere Terra / Fashion  
wood Terra oak  
L/W150 P/D50 H54,2

**Musa madia / display cabinets**  
Laccato opaco Arena / Matte lacquer  
Arena  
L/W130 P/D52,7 H145

**Oslo 2 divano / sofa**  
Tessuto Ranger 25 / Ranger 25 fabric  
L/W260 P/D92 H83

**Oslo 2 poltrona / poltrona**  
Tessuto Fenkè unito 701 / Fenkè unito  
701 fabric  
L/W80 P/D92 H83



## OSLO 2

design Enrico Cesana

Oslo 2 è un divano in cui le morbide imbottiture si fondono alla forma regolare di base e braccioli. Piacevolmente sospeso da piedi in metallo verniciato, Oslo 2 è disponibile in tre larghezze e due varianti di poltrona.

The Oslo 2 sofa features soft padding that appears to sink into the regular shape of its base and armrests. Pleasantly suspended by painted metal feet, Oslo 2 is available in three widths and two armchair versions.

**Materiali e finiture**  
Rivestimento: Tessuti, Pelle.

**Materials and finishes**  
Covering: Fabric, Leather.

### Piedini disponibili / Available feet



Y01



Y02

### Divani / Sofas

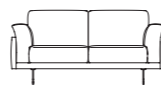

**180 / 220 / 260**  
70 3/4" 86 1/2"  
102 1/4"

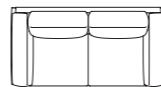

**92**  
36 1/4"

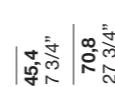

**45,4**  
17 3/4"



**70,8**  
27 3/4"

### Moduli centrali / Central units

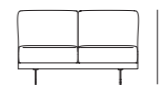

**140 / 180 / 220**  
55" 70 3/4"  
86 1/2"

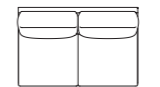

**92**  
36 1/4"



**45,4**  
17 3/4"



**70,8**  
27 3/4"

### Moduli terminali / End units

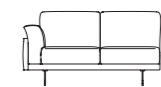

**160 / 200 / 240**  
63" 78 3/4"  
94 1/2"

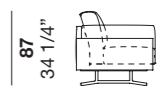
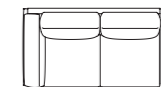

**92**  
36 1/4"



**45,4**  
17 3/4"



**70,8**  
27 3/4"

### Angolo / Corner unit



**94**  
37"



**94**  
37"



### Chaise longue



**115**  
45 1/4"

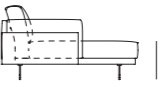

**162**  
63 3/4"



**45,4**  
17 3/4"



**70,8**  
27 3/4"

### Poltrona / Armchair



**80**  
31 1/2"



**92**  
36 1/4"



**55**  
21 3/4"

# Ladigue

Simili a un confortevole abbraccio, le linee di Ladigue circondano il corpo e creano una sensazione di accogliente benessere. La sua realizzazione sartoriale è evidenziata dal rivestimento con morbide pence. La versione con sedute allungabili permette di adattarsi a ogni esigenza e desiderio personale, con un semplice gesto.

Just like a comforting hug, Ladigue's lines wrap around you to create a cosy feeling of wellbeing. Its tailored designed is accented by soft darts in the upholstery. The version with extendable seats can be adapted to suit all your needs and wants, with a simple gesture.

design Enrico Cesana





**Norman** tavolino / occasional table  
Laccato Pacifico opaco e lucido /  
Matt and high gloss Pacifico lacquered  
L/W100 P/D100 H33,6

**Ladigue** divano / sofa  
Tessuto Nina 37 /  
Nina 37 fabric  
L/W254 P/D104 H74

**Ladigue** divano / sofa  
Tessuto Nina 23 /  
Nina 23 fabric  
L/W294 P/D104 H74



**Life** tavolino / occasional table  
Modica opaco / matte Modica  
L/W46 P/D46 H52  
L/W55 P/D45 H42

**Ladigue** divano / sofa  
Tessuto Taiga 01 colore 90-3 / Taiga 01  
color 90-3 fabric  
L/W354 P/D102 H74

**Denny** pouf  
Tessuto ecopelle Time 800 / Ecopelle time  
800 fabric  
L/W85 P/D85 H37

**Diko** credenza / sideboard  
Laccato Modica lucido / High gloss  
lacquer Modica  
L/W194,8 P/D45,4 H67



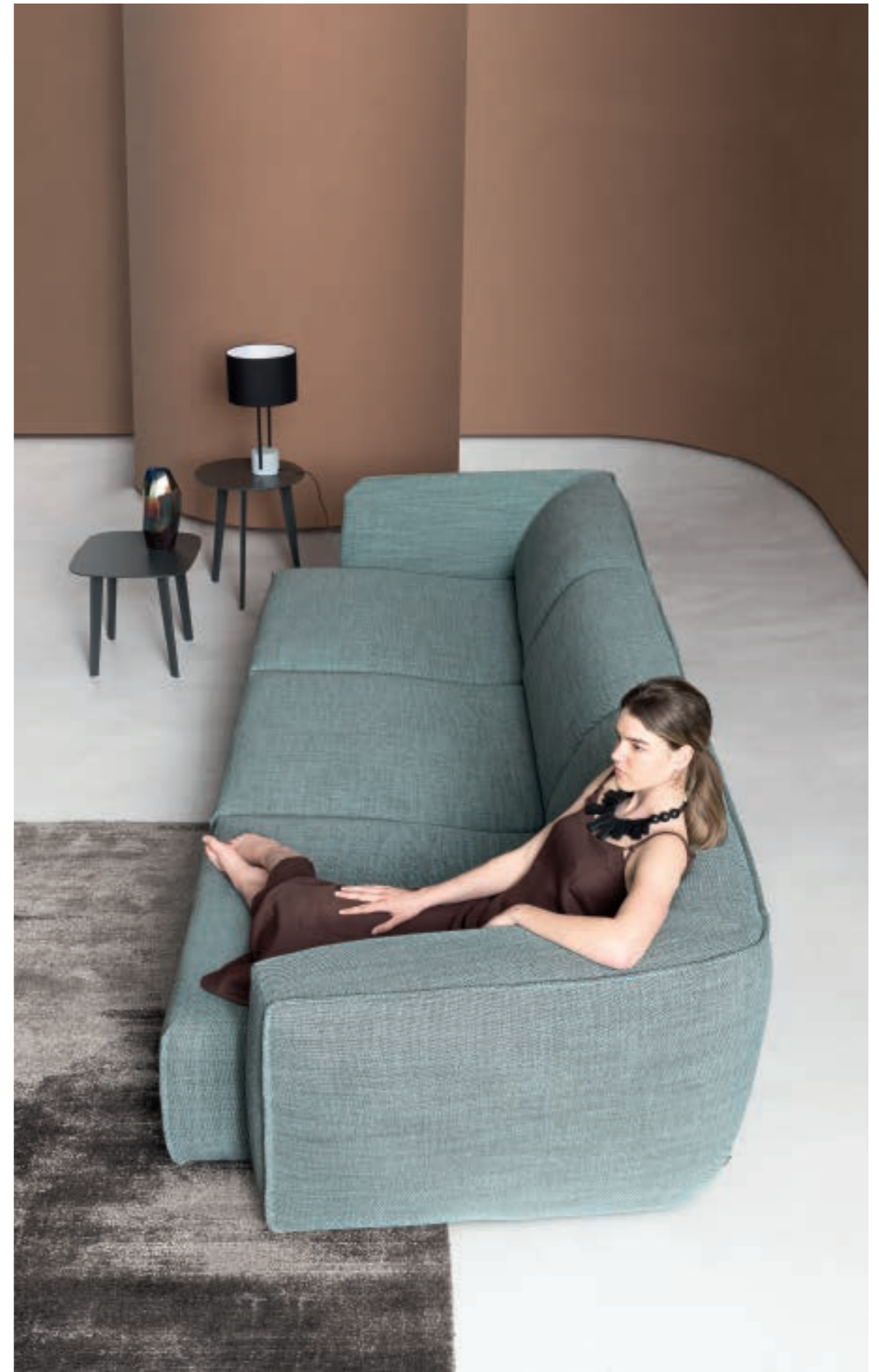

# LADIGUE

design Enrico Cesana



Ladigue è un divano componibile dallo stile soft e dall'aspetto morbido ed accogliente. Un design valorizzato da pence e morbide pieghe. È possibile trasformare la profondità della seduta a proprio piacimento con un semplice gesto; una seduta "su misura" in grado di adattarsi al millimetro alle esigenze di tutti.

Materiali e finiture  
Rivestimento: Tessuti, Pelle.

Ladigue is a modular sofa with soft style and a comfortable, inviting appearance. The design features darts and gentle folds. The depth of the seat can be adjusted to suit your preferences in one simple step; a tailor-made seat that adapts to everyone, down to the finest detail.

Materials and finishes  
Covering: Fabric, Leather.

## Moduli terminali / End units

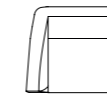
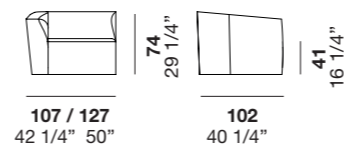

## Moduli centrali / Central units

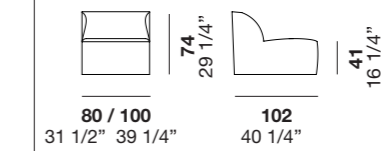

## Chaise longue

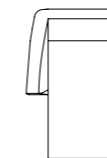
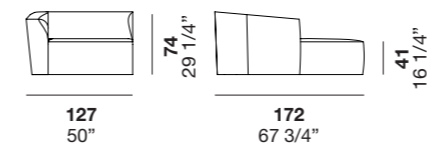

## Angolo / Corner unit

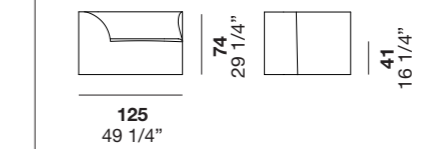

# Nevada

Forme classiche e spirito contemporaneo si incontrano in Nevada, un progetto adatto a una dimora tradizionale come a un'architettura di tendenza. Il particolare design del bracciolo è l'elemento caratterizzante di questo ampio programma modulare, con la possibilità di scegliere fra un'ampia gamma di rivestimenti in pelle e tessuto.

Nevada combines classic shapes and a contemporary spirit, ideal both for traditional homes and trendy pieces of architecture. The unique armrest design features throughout this modular collection, available in a wide range of leather and fabric covers.

design Enrico Cesana







**Nevada** divano / sofa  
Tessuto Fado 2 / Fado 2 fabric  
L/W470,4 P/D285 H81,7

**Neyō** tavolino / occasional table  
Struttura Moka Shine, Piano Mamo Carrara  
/ Structure Moka Shine, Top in Carrara  
Marble  
L/W60 P/D38 H42

**Denny** pouf  
Pelle Lord 9120 / 9120 Lord leather  
L/W85 P/D85 H37

**Nevada divano / sofa**  
Tessuto Fado 2 / Fado 2 fabric  
L/W302 P/D146 H81,7

**Moca tavolino / occasional table**  
Struttura laccato Nero opaco, piano  
Fashion wood rovere Fossile /  
Structure in matt Nero lacquered, Top in  
Fashion wood Fossile oak  
L/W90 P/D90 H37

**Nevada pouf**  
Tessuto Dali 04 / Dali 04 fabric  
L185 P86 H44





**Diko** madia / cabinet  
 Ante groove Noce naturale, fianchi  
 e top laccato opaco Moka shine e  
 basamento Moka shine / Natural walnut

groove doors, Moka shine matte lacquer  
 sides and top, and Moka shine basement  
 L/W98,8 P/D45,7 H147

**Nobu** pouf  
 Tessuto Made F, 21 piano Moka shine /  
 Made F21 fabric, Moka shine top  
 L/W38,6 P/D42,6 H44

**Nobu** pouf  
 Tessuto Senky unito 006 / Senky unito  
 006 fabric  
 L/W38,6 P/D42,6 H44

**Nevada** divano / sofa  
 Tessuto Please 600 / Please 600 fabric  
 L/W352 P/D102 H81,7

**Denny** pouf  
 Tessuto Nina 37 / Nina 37 fabric  
 L/W55 P/D55 H42

**Denny** pouf  
 Tessuto Please 600 / Please 600 fabric  
 L/W85 P/D85 H37



# NEVADA

design Enrico Cesana

Nevada è un divano componibile che con la sua immagine sobria e informale esprime il perfetto equilibrio tra tradizione e contemporaneità. Le forme sono classiche ma la particolare geometria del bracciolo, la dimensione dei cuscini seduta, e l'essenzialità dei piedini in metallo rimandano definitivamente al gusto contemporaneo. La varietà dei moduli disponibili e la possibilità di rivestimento in tessuto e in pelle, rendono Nevada un divano adatto agli spazi e agli stili più diversi.

Nevada is a modular sofa that, with its simple, informal look, expresses a perfect balance between tradition and modernity. The shapes are classic but the unusual geometry of the armrests, the size of the seat cushions, and the simplicity of the metal feet defnitely evoke a contemporary flavour. The variety of modules available and the fabric or leather upholstery make Nevada a sofa that suits very different rooms and styles.

Materiali e finiture  
Rivestimento: Tessuti, Pelle.

Materials and finishes  
Covering: Fabric, Leather.

## Divani / Sofas

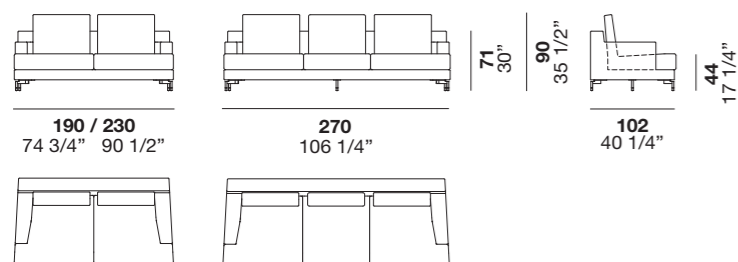

## Moduli terminali sx o dx / Left or Right facing end units

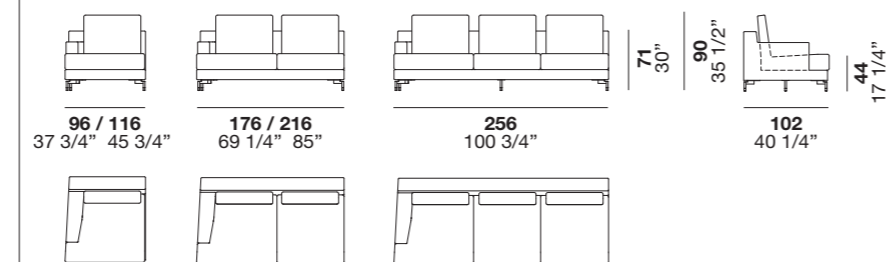

## Moduli penisola / Peninsula units

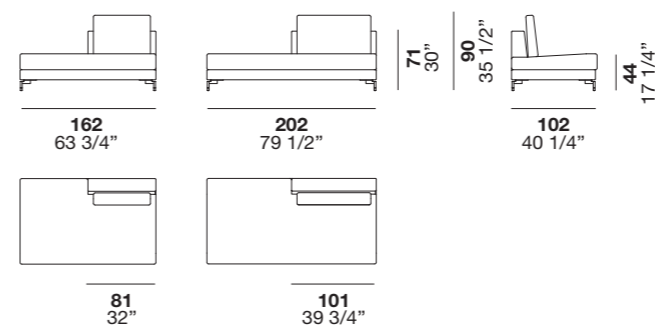

## Moduli penisola inclinata / Angled lounge units

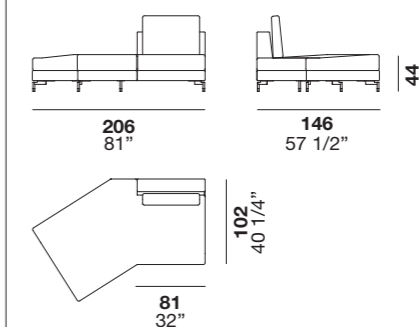

## Moduli centrali / Central units

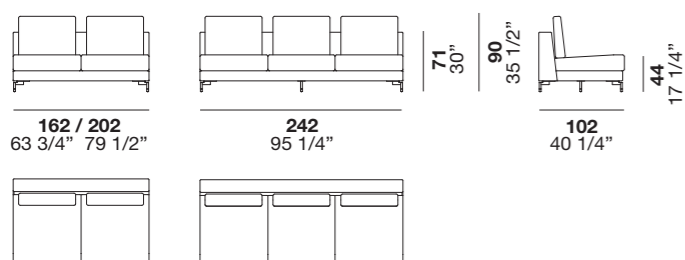

## Angoli / Corner units

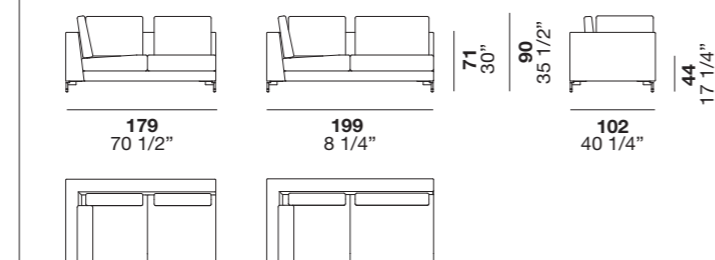

## Pouf

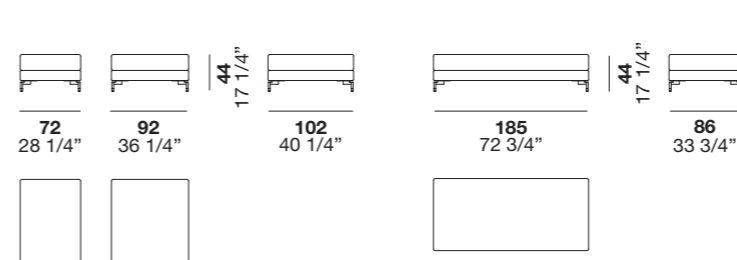

## Chaise longue sx o dx / Left or Right facing chaise longue

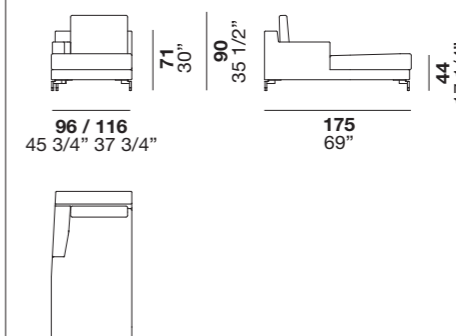

<sup>IT</sup> Poltrone e pouf per creare situazioni accoglienti e rilassanti, in sintonia con gli spazi, i gusti, i desideri di ognuno. Dallo spazio living al guardaroba, fra le pareti domestiche come negli ambienti collettivi o nelle boutique di tendenza. Complementi indispensabili per il benessere e lo stile di vita quotidiano, con una qualità che dura nel tempo.

<sup>EN</sup> Armchairs and footstools create cosy, relaxing set-ups, in tune with the space, and with personal tastes and preferences. From the living room to the wardrobe, they work in your home and in communal spaces or trendy boutiques. They are essential pieces of furniture for your everyday lifestyle and wellbeing, with quality that lasts.

- 124 Raku
- 134 Olivia
- 142 Lisa
- 146 Denny
- 152 Nobu



# Raku

Essenziali e accoglienti, le poltrone, i divani e i complementi Raku hanno forme arrotondate, sostenute da tubolari metallici che sembrano solo appoggiati sui loro volumi. L'ampia scelta di rivestimenti, in pelle o tessuto, permette un ideale inserimento in ogni contesto d'arredo.

Simple yet inviting, Raku armchairs, sofas and furnishings have rounded lines and are supported by tubular metal legs that appear to be simply resting in place. The wide range of leather or fabric upholstery means this piece can fit perfectly into any interior setting.

design Gordon Guillaumier

**Raku** poltrona / armchair  
Tessuto Nina 6 / Nina 6 fabric  
L/W83 P/D66 H73

**Neyō** tavolino / occasional table  
Struttura Moka Shine, Piano Marmo  
Carrara / Moka Shine structure, Top  
Carrara marble  
L/W60 P/D38 H42





**Raku** poltrona / armchair  
Tessuto Nina 23 / Nina 23 fabric  
L/W83 P/D66 H73

**Neyō** tavolino / occasional table  
Struttura Moka Shine, Piano Marmo  
Carrara / Moka Shine structure, Top  
Carrara marble  
L/W60 P/D38 H42



**Raku** divanetto / sofa  
Tessuto Regal E044 / Regal E044 fabric  
L/W158 P/D66 H73

**Malmo** tavolino / occasional table  
Struttura Moka Shine, Piano Fashion wood  
rovere Naturale / Structure in Moka Shine,  
Top in Fashion wood Naturale oak  
L/W42 P/D42 H50





**Raku** panca con bracciolo / bench  
with armrest  
Tessuto Regal E048, bracciolo Fashion  
wood rovere Naturale / Regal E048 fabric,  
Armrest in Fashion wood Naturale oak  
L/W150 P/D68 H53

**Disco** specchiera / mirror  
Cornice Moka shine / Moka shine frame  
L/W99,5 P/D4 H99,5  
L/W49,7 P/D4 H49,7



# RAKU

design Gordon Guillaumier

La collezione di sedute imbottite Raku – che comprende poltrona + pouf, divanetto, sedia e panca – ha un'immagine contemporanea ed essenziale. Seduta e schienale sono definiti da volumi semplici e arrotondati. Il piede, altrettanto essenziale, è formato da un tubo verticale che sembra solo appoggiato all'esterno dei volumi. La panca imbottita prevede anche un bracciolo in legno che la divide trasversalmente creando un funzionale piano di appoggio. Disponibile con rivestimento in pelle, ecopelle e in tessuto, Raku è perfetta per regalare un tocco di comfort alla zona giorno, come alla zona notte.

The Raku collection of upholstered seats – which includes an armchair + footstool, small sofa, chair and bench – has a simple, contemporary look. The seat and back are defined by simple, rounded volumes. The equally simple leg is formed of a vertical bar that looks like it is resting against the outer edge of the chair back. The upholstered bench also has a wooden armrest that divides it widthways, creating a functional surface for resting things on. Available with leather, ecoleather and fabric upholstery, Raku is perfect for adding a touch of comfort to the lounge and bedroom.

Materiali e finiture  
Rivestimento: Tessuti, Pelle, Ecopelle.

Materials and finishes  
Covering: Fabric, Leather, Ecoleather.

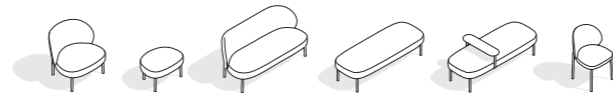

RAKU family

## Poltrona / Armchair

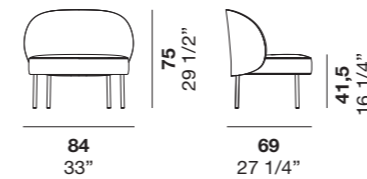

## Pouf

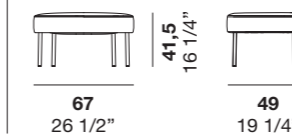

## Divano / Sofa

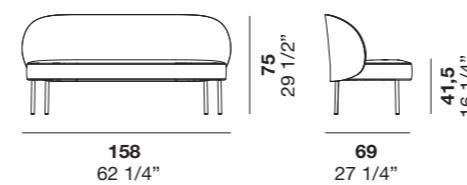

## Panca / Bench

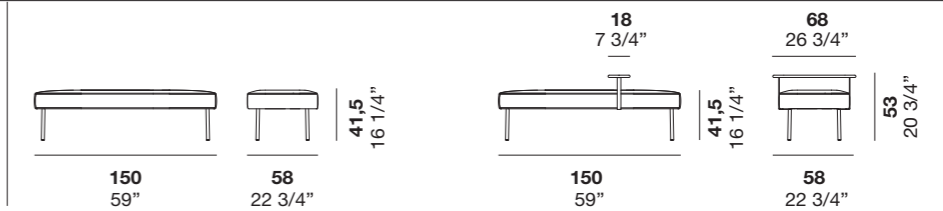

# Olivia

Olivia è una poltrona girevole che permette di accomodarsi nelle posizioni più diverse, grazie al suo design ampio e aperto. Il poggiatesta coordinato aggiunge un elemento di comfort in più, durante la lettura oppure per godersi una pausa di riposo durante la giornata.

Olivia is a swivel armchair with a wide, open seat design so you can sit comfortably in many different positions. The matching footrest adds an extra element of comfort, for reading or enjoying a restful break during the day.

design Bruna Vaccher





Olivia poltrona / armchair  
 Pelle Scamoscita Seppia, basamento  
 Moka shine / Seppia Scamoscita leather,  
 basement in Moka shine  
 L/W106 P/D93 H89

Olivia poggiapiedi / footstool  
 Pelle Scamoscita Seppia, basamento  
 Moka shine / Seppia Scamoscita leather,  
 basement in Moka shine  
 L/W68 P/D49 H41



Poltrone / Armchairs



Olivia poltrona / armchair  
 Tessuto Ranger 25, basamento Moka shine  
 / Ranger 25 fabric, basement in Moka shine  
 L/W106 P/D93 H89

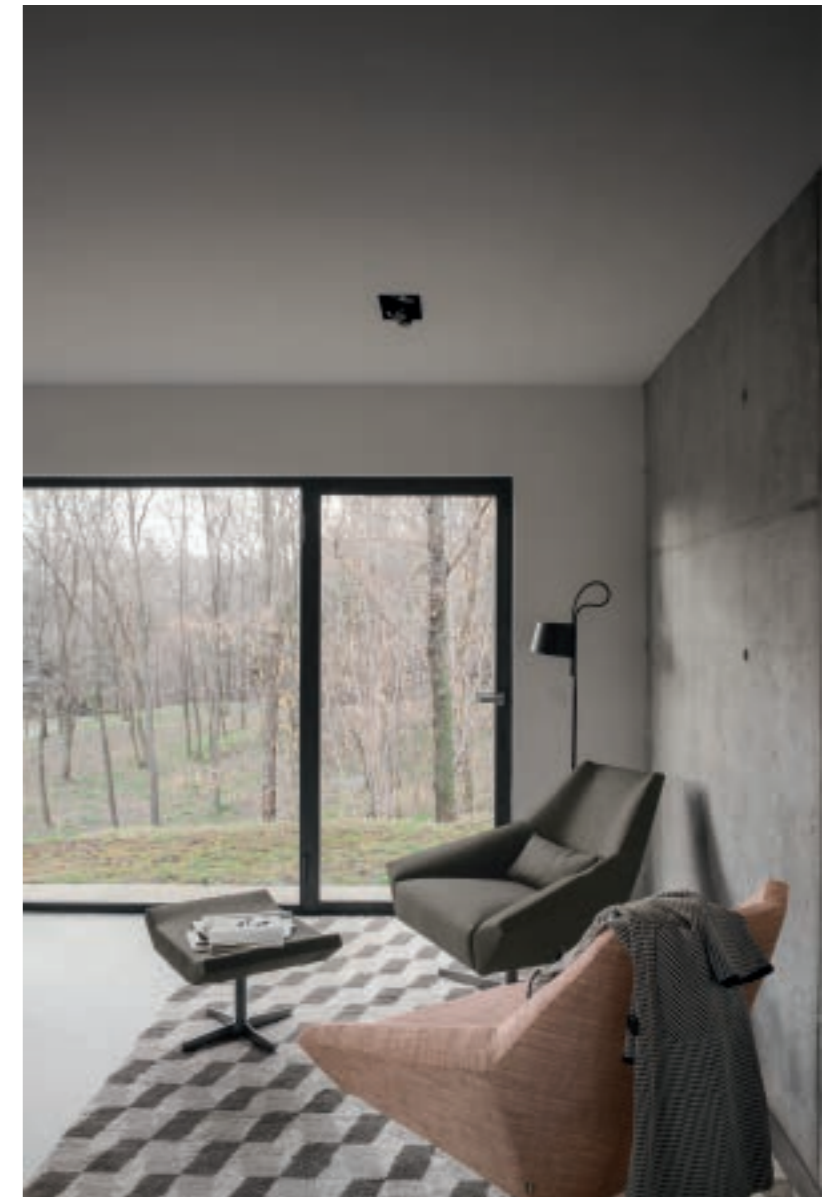

Olivia poggiapiedi / footstool  
 Tessuto Ranger 25, basamento Moka shine  
 / Ranger 25 fabric, basement in Moka shine  
 L/W68 P/D49 H41

Olivia poltrona / armchair  
 Tessuto Senky Unito 010, basamento Moka  
 shine / Senky Unito 010 fabric, basement in  
 Moka shine  
 L/W106 P/D93 H89



Olivia poltroncina / armchair  
Tessuto Nina 6/ Nina 6 fabric  
L/W106 P/D93 H89

Tsuki tavolino / occasional table  
Struttura verniciato moka shine e piano  
vetro bronzo satinato / Structure painted

in Moka Shine and satin-finish bronze  
glass top  
L/W60 P/D54,36 H42

## OLIVIA

design Bruna Vaccher

Olivia è una poltrona e poggiatesta imbottiti con basamento girevole in metallo. Il design di Olivia è caratterizzato dalla forma "aperta" con un accenno di deformazione ad indicare la possibilità ad accogliere le più svariate posizioni.

**Materiali e finiture**  
Rivestimento: Tessuti, Pelle, Ecopelle.  
Basamento: Metallo.

Olivia is a padded armchair and footstool pair with a metal swivel base. Olivia's design is open and features a hint of contortion to show how it can be suited to the most varied of positions.

**Materials and finishes**  
Upholstery: Fabric, leather, ecoleather .  
Base: metal.

Poltrona / Armchair

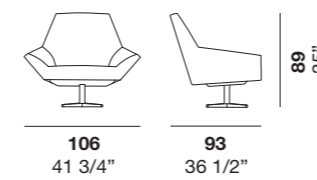

Pouf

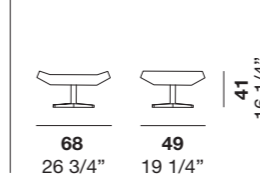

# Lisa

Un concetto di relax ed eleganza per ogni ambiente e situazione: la poltrona Lisa è proposta in versione con piedini oppure con base girevole. Il rivestimento in tessuto o pelle, avvolge il suo volume accogliente e confortevole.

Relaxation and elegance in any space and setting: the Lisa armchair comes in a version with feet or with a swivel base. A fabric or leather cover wraps around this inviting piece.

design R&D Alf DaFrè





**Lisa** poltroncina / armchair  
Tessuto Iris 406 / Iris 406 fabric  
L/W89 P/D94,5 H92

**Wok** tavolini / occasional tables  
Laccato opaco Moka shine / Matte lacquer  
Moka shine  
L/W27,5 P/D27,5 H50

**Wok** tavolini / occasional tables  
Laccato opaco Amaranto/ Amaranto matte  
lacquer  
L/W27,5 P/D27,5 H50

**Diko** madia / cabinet  
Laccato opaco Amaranto e basamento  
Moka shine / Amaranto matte lacquer and  
Moka shine basement  
L/W98,8 P/D45,7 H131

## LISA

design R&D Alf DaFrè

Lisa ha forme morbide, arrotondate, accoglienti. Lo schienale prosegue nei fianchi racchiudendo la seduta.

**Materiali e finiture**  
Rivestimento: Tessuti, Pelle.

Lisa has soft, rounded forms for an inviting look. The back continues into the sides, closing in the seat.

**Materials and finishes**  
Covering: Fabric, Leather.

Poltrona con piedini / Armchair with feet

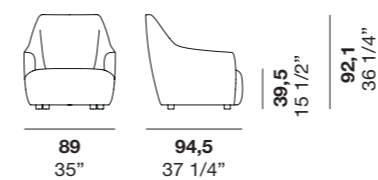

Poltrona con basamento girevole / Armchair with swivel base



# Denny

Confortevole e amichevole, Denny è un pouf dalle forme tondeggianti, proposto in quattro misure e utilizzabile come seduta o come poggiatesta. Pratico ed elegante, il rivestimento sfoderabile in tessuto è disponibile in un'ampia palette colori.

Comfortable and friendly, Denny is a rounded footstool that comes in four sizes, and can be used as a seat or footrest. Both practical and elegant, the removable fabric cover comes in many colours.

design R&D Alf DaFrè





Denny pouf / pouf  
Tessuto ecopelle Time 800 / Ecopelle Time  
800 fabric  
L/W85 P/D85 H72

Denny pouf / pouf  
Tessuto Nina 37 / Nina 37 fabric  
L/W55 P/D55 H42

Denny pouf / pouf  
Tessuto Ranger 33 / Ranger 33 fabric  
L/W130 P/D130 H37

Denny pouf / pouf  
Tessuto Fado 11 / Fado 11 fabric  
L/W142 P/D55 H42

Wok tavolini / occasional table  
Laccato opaco Tortora / Matte lacquer  
Tortora  
Ø27,5 H50



# DENNY

design R&D Alf DaFrè

Denny è un pouf imbottito e sfoderabile (nella versione tessuto) disponibile in tre misure. Caratterizzato da forme tondeggianti e rastremate funge da seduta o pratico appoggio.

Denny is a padded footstool with removable cover (in the fabric version), which is available in three sizes. It is distinguished by rounded and tapered shapes, and it can be used as either a seat or a practical rest.

**Materiali e finiture**  
 Rivestimento: Tessuti, Pelle, Ecopelle.

**Materials and finishes**  
 Upholstery: Fabric, Leather, Ecoleather.

## Pouf

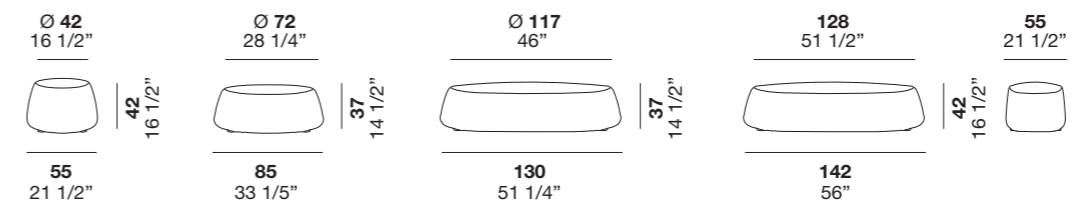

Sofa

Denny

Poltrone / Armchairs

# Nobu

Nobu è un vero tuttofare: utilizzabile come una comoda seduta supplementare, è dotato di un coperchio imbottito che nasconde al suo interno un vassoio portaoggetti. Un capiente vano contenitore completa la sua funzionalità. La scelta fra numerosi rivestimenti, lo rende versatile anche nell'estetica.

Nobu is an all-rounder: it can be used as extra comfy seating, and has a padded lid that hides a storage tray inside. A roomy storage compartment completes this practical piece. A choice of upholstery also gives it a versatile look.

design Raffaella Mangiarotti



**Nobu pouf**  
Tessuto Senky unito 006, vassoio Nickel/  
Senky unito fabric, Nickel tray  
L/W38,6 P/D42,6 H44

**Nobu pouf**  
Tessuto ecopelle Time 799, vassoio Nickel/  
Ecopelle Time 800 fabric, Nickel tray  
L/W38,6 P/D42,6 H44



**Nobu pouf**  
Tessuto Antibes 904 e vassoio Nickel /  
Antibes 904 fabric and Nickel tray  
L/W38,6 P/D42,6 H44

**Nobu pouf**  
Tessuto Antibes 301 e vassoio Nickel /  
Antibes 301 fabric and Nickel tray  
L/W38,6 P/D42,6 H44

**Nobu pouf**  
Tessuto Antibes 206 e vassoio Nickel /  
Antibes 206 fabric and Nickel tray  
L/W38,6 P/D42,6 H44



**Kobe** tavolino / occasional table  
Nero opaco / Matte black  
L/W120 P/D70 H33

**Moca** tavolino / occasional table  
Nero opaco / Matte black  
L/W60 P/D60 H45,4

**Nobu** pouf  
Tessuto Senky unito 006 e vassoio  
Nickel / Senky unito 006 fabric and  
Nickel tray  
L/W38,6 P/D42,6 H44

## NOBU

design Raffaella Mangiarotti

Nobu è un comodino / pouf imbottito con parte superiore removibile che "cela" un vassoio in metallo.

Nobu is an upholstered bedside table / footstool with a removable top that "conceals" a metal tray.

**Materiali e finiture**  
Rivestimento: Tessuti, Pelle, Ecopelle.  
Vassoio: Moka Shine, laccato micalizzato Nickel.

**Materials and finishes**  
Upholstery: Fabric, leather, ecoleather.  
Tray: Moka Shine, Nickel micalised lacquer.

Pouf

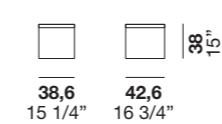
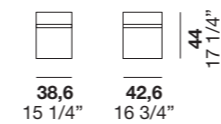

<sup>IT</sup> Tavolini che completano ogni situazione con la loro funzionalità, contribuendo a creare atmosfere affascinanti con il loro design. Complementi protagonisti della qualità dell'abitare contemporaneo.

<sup>EN</sup> Occasional tables complement any look, providing a practical piece and helping to create atmosphere with their design. Taking centre stage, they ensure quality contemporary living.

- 160 Tsuki
- 164 Neyō
- 168 Malmo
- 174 Kobe / Handy Kobe
- 182 Life
- 186 Moca
- 190 Tuft
- 198 Wok
- 202 Norman



# Tsuki

Come un'immagine suggestiva in una notte di luna piena, il piano in vetro satinato di Tsuki lascia trasparire la forma organica della struttura in metallo verniciato. Un concetto di design ispirato all'arte giapponese, declinato in modelli di diverse dimensioni.

Like an evocative image of a full moon at night, Tsuki's satin-finished glass top reveals the organic shape of the painted metal frame below. The design concept is inspired by Japanese art, and comes in different sized models.

design Gordon Guillaumier





**Tsuki tavolini / occasional tables**  
 Struttura verniciato Moka Shine, piano  
 vetro Bronzo satinato / Structure painted in  
 Moka Shine, Satin-finish bronze glass top  
 L/W101,7 P/D99,8 H28  
 L/W104,5 P/D76,8 H35  
 L/W60 P/D54,3 H42

## TSUKI

design Gordon Guillaumier

Registered design

Tsuki è una linea di tavolini con struttura metallo e piano in vetro temprato e filo tondo satinato.

Tsuki is a range of occasional tables with a metal frame, tempered-glass top and rounded satin-finished edge.

**Materiali e finiture**  
 Struttura verniciato Moka Shine.  
 Piano vetro bronzo satinato.

**Materials and finishes**  
 Frame painted in Moka Shine.  
 Satin-finish bronze glass top.

Tavolino / Occasional table

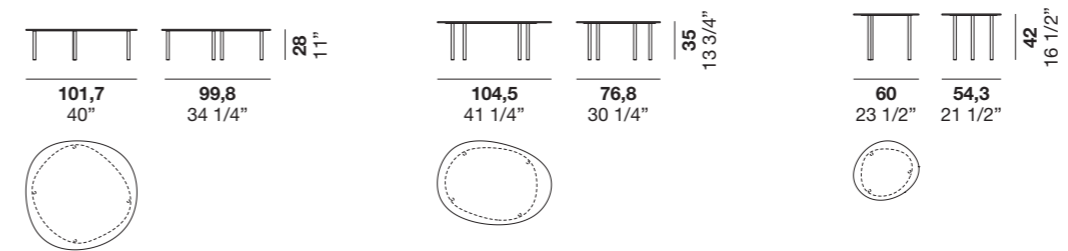

# Neyō

Ideale come tavolino nella zona giorno, ma anche come complemento nell'ambiente notte, Neyō si distingue per le forme tondeggianti, create abbinando una struttura metallica con un piano in marmo di Carrara.

Ideal as an occasional table for the living area, or to furnish the bedroom, Neyō has rounded forms, created by combining a metal frame with a Carrara marble top.

design Gordon Guillaumier





## NEYŌ

design Gordon Guillaumier

Complemento ideale sia per la zona giorno che per la camera da letto il tavolino Neyō è caratterizzato dalla struttura in metallo verniciato Moka Shine e il piano dalla linea curva disponibile nelle varianti Fashion wood, rovere laccati opachi o marmo di Carrara.

**Materiali e finiture**  
 Struttura metallo: Verniciato Moka Shine  
 Piano: Fashion wood, Rovere laccati opachi, Marmo di Carrara

The ideal complement for both the living area and the bedroom, the Neyō occasional table has a metal frame in the Moka Shine finish and a curved top available in Fashion Wood, matt lacquered oak or Carrara marble.

**Materials and finishes**  
 Metal frame: Painted Moka Shine  
 Top: Fashion Wood, Matt lacquered oak, Carrara marble

Tavolino / Occasional table

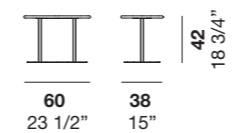

Neyō tavolino / occasional table  
 Verniciato Moka Shine, top Marmo di Carrara / Painted Moka Shine, Carrara marble top  
 L/W60 P/D38 H42

# Malmo

I tavolini Malmo uniscono forme semplici e leggere, con una solidità destinata a durare nel tempo. La struttura in metallo, minimale e geometrica, sostiene un piano in legno con i bordi smussati, creando un raffinato contrasto di materiali e volumi.

Malmo occasional tables combine simple, light forms with a solid structure built to last. The minimalist, geometric metal frame supports a wooden top with bevelled edges, creating elegant textural and volumetric contrasts.

design Enrico Cesana



**Malmo** tavolino / occasional table  
Laccato lucido Origano / High gloss  
Origano lacquer  
L/W100 P/D100 H41,3



Malmo tavolino / occasional table  
Laccato opaco Juta / Matte Juta lacquer  
L/W42 P/D42 H50





# MALMO

design Enrico Cesana

Ispirato alla geometria cartesiana ed alla possibilità di creare sovrapposizioni e intersezioni al servizio della funzionalità domestica. Elementi geometrici ma decisamente "dolci", ottenute dalla sovrapposizione dei piani smussati e dai raggi di raccordo della struttura metallica.

Inspired by Cartesian geometry and the possibility of creating overlaps and intersections that serve a domestic purpose. The geometric shapes are softened significantly by overlapping rounded tops and the connecting beams of the metal frame.

**Materiali e finiture**  
 Struttura: Verniciato Moka Shine, Verniciato bianco, Laccati opachi, Laccati micalizzati.  
 Piano: Roveri laccati opachi, Fashion wood, Laccati opachi e lucidi, Laccati Micalizzati.

**Materials and finishes**  
 Frame: Moka Shine painted, Bianco painted, Matt lacquers, Micalised lacquers.  
 Top: Matt lacquered oak, Fashion Wood, Matt and high-gloss lacquers, Micalised lacquers.

## Tavolini / Occasional tables

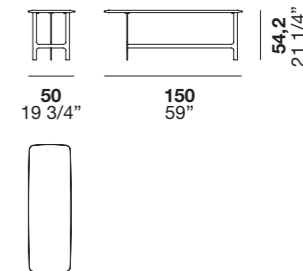
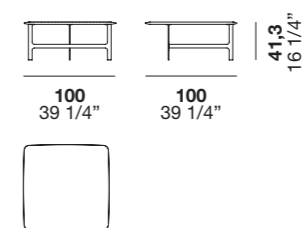
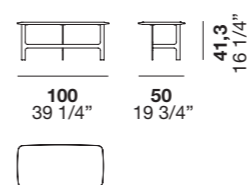
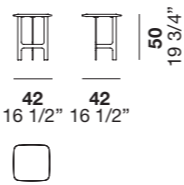

# Kobe / Handy Kobe

Razionalità ed eleganza: questo in estrema sintesi è lo stile di Kobe, un tavolino con piano in legno o ceramica che si integra nella struttura metallica, creando un'affascinante sensazione di continuità fra diversi materiali.

Rational and elegant: that's Kobe in a nutshell. This occasional table can be made with a wooden or ceramic top incorporated into a metal frame, to create continuity between the different materials.

design R&D Alf DaFrè





**Kobe** tavolino / occasional table  
Struttura laccato Platino opaco, piano  
Laminam Fokos Sale / Structure in matt  
Platino lacquer, Top in Laminam Fokos Sale  
L/W120 P/D70 H33



**Kobe** tavolino / occasional table  
 Struttura laccato Nero opaco, piano  
 Laminam Fokos Sale / Structure in matt  
 Nero lacquer, Top in Laminam Fokos Sale  
 L/W120 P/D70 H33

**Moca** tavolino / occasional table  
 Struttura e piano laccato Nero opaco /  
 Structure and top in matt Nero lacquered  
 L/W60 P/D60 H45,4



**Handy Kobe** tavolino / occasional table  
 Struttura laccato Moka Shine, piano in  
 Fashion wood Rovere Terra /  
 Structure in Moka Shine lacquered, top in  
 Terra Oak Fashion wood  
 L/W45 P/D45 H50



## KOBE / HANDY KOBE

design R&D Alf DaFrè

Kobe è un tavolino quadrato o rettangolare con struttura in metallo verniciato e piano legno o ceramica. Estremamente pulito nella linea è disponibile in tre misure.

Kobe is a square or rectangular occasional table with a painted metal structure and a wooden or ceramic top. It has an extremely clean-cut silhouette and it is available in three sizes.

### Materiali e finiture

Piano: Nobilitati, Noce, Fashion wood, Roveri laccati opachi, Laccati opachi e lucidi, Laccati micalizzati.

Struttura: Verniciato bianco o Moka shine, Laccati opachi, Laccati micalizzati.

### Materials and finishes

Top: Surfaced, Walnut, Fashion wood, Oak matt colours, Matt or high gloss lacquers, Micalised lacquers.

Structure: Bianco or Moka shine painted, Matt lacquers, Micalised lacquers.

### Tavolini / Occasional tables

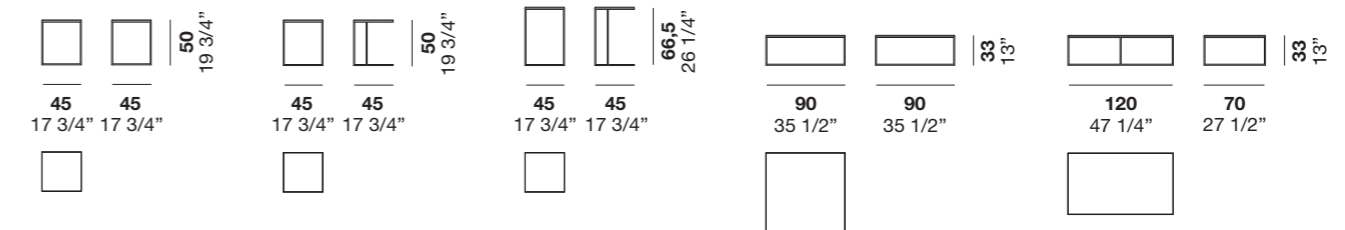

### Ceramiche per piano / Top ceramics

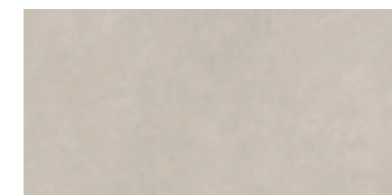

Laminam Fokos Sale

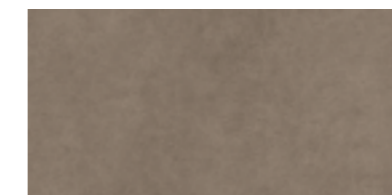

Laminam Fokos Terra

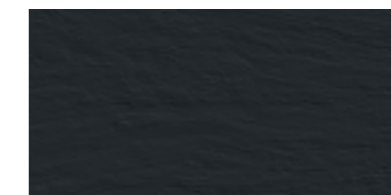

Laminam Ardesia a Spacco

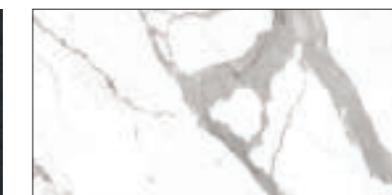

Laminam bianco Statuario Venato Lucidato



Laminam Sahara Noir Extra Lucidato



Neolith Himalaya Crystal Ultrasoft

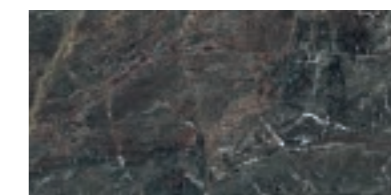

Neolith Amazonico Polished

**Kobe** tavolino / occasional table  
 Struttura laccato Nero opaco, piano  
 Laminam Fokos Sale / Structure in matt  
 Nero lacquer, Top in Laminam Fokos Sale  
 L/W120 P/D70 H33

**Copenaghen** divano / sofa  
 Tessuto Senky unito 006 / Senky unito 006  
 fabric  
 L/W215 P/D310 H75

# Life

Life è una famiglia di tavolini che si prestano a completare gli spazi e i momenti più diversi della quotidianità. La struttura in legno si distingue per le gambe inclinate e dinamiche, mentre il piano è proposto con diverse forme e dimensioni.

Life is a range of occasional tables you can use to complete the most diverse of spaces, for everyday living. The wooden frame features dynamic, tapered legs, while the top comes in different shapes and sizes.

design Haften Studio





Life tavolini / occasional tables  
 Laccato Modica opaco / Matte lacquer  
 Modica  
 L/W46 P/D46 H52  
 L/W55 P/D45 H42

# LIFE

design Haften Studio

Life è un tavolino con struttura legno disponibile in tre varianti: rotondo con tre gambe e rettangolare con quattro gambe in due misure.

**Materiali e finiture**  
 Struttura: Fashion wood, Roveri laccati opachi, Laccati opachi Laccati micalizzati.

The Life occasional table has a wooden structure available in three versions: round with three legs, or rectangular with four legs, in two different sizes.

**Materials and finishes**  
 Structure: Fashion wood, Oak matt colours, Matt lacquers, Micalised lacquers.

## Tavolini / Occasional tables

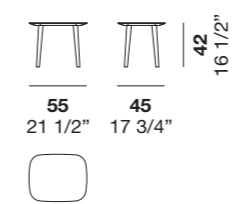
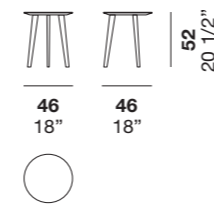

# Moca

Piacevolmente immediato nel design, Moca è un tavolino rotondo che si può utilizzare in un'infinità di spazi e situazioni. Il piano in legno sembra sospeso sulla struttura in metallo, sottile ma al tempo stesso robusta.

Pleasantly effective and seamless, the Moca occasional table can be used in an infinite number of spaces and situations. The wooden top looks as though it is floating on top of a slim yet sturdy metal frame.

design R&D Alf DaFrè

**Moca** tavolini / occasional tables  
Laccato Nero opaco / Matt Nero lacquer  
L/W90 P/D90 H45,4  
L/W60 P/D60 H37





**Moca** tavolino / occasional table  
 Struttura laccato Nero opaco, piano  
 laccato micalizzato Oro / Structure matt  
 Nero lacquer, top Micalised Oro lacquer  
 L/W60 P/D60 H45,4

**Wok** tavolino / occasional table  
 laccato Nero opaco / matt Nero lacquer  
 L/W27,5 P/D27,5 H50

## MOCA

design R&D Alf DaFrè

Moca è un tavolino rotondo con struttura in metallo verniciato e piano legno. Moca è disponibile in due misure.

The Moca round occasional table has a painted metal structure and a wooden table top. Moca is available in two sizes.

### Materiali e finiture

Piano: Fashion wood, Roveri laccati opachi, Laccati opachi e lucidi, Laccati micalizzati.  
 Struttura: Verniciato bianco o Moka shine, Laccati opachi, Laccati micalizzati.

### Materials and finishes

Top: Fashion wood, Oak matt colours, Matt or high gloss lacquers, Micalised lacquers.  
 Structure: Bianco or Moka shine painted, Matt lacquers, Micalised lacquers.

### Tavolini / Occasional tables

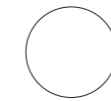
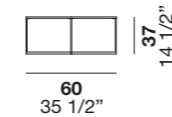
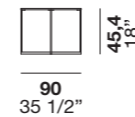

# Tuft

Il piano rotondo di Tuft ha i bordi rialzati, come un vassoio. Il suo volume leggero è sospeso su una struttura in metallo, con le gambe sagomate e sottili che ne accentuano il dinamismo visivo. È proposto in due dimensioni, anche con un inserto in legno o ceramica da inserire nel top.

Tuft's round top has a lip around the edge, like a tray. Its lightweight top design stands on a metal frame, with slender, shaped legs accentuating the dynamic visuals. It comes in two sizes, and has a wooden or ceramic insert for the top.

design Enrico Cesana





Tuft tavolini / occasional tables  
Verniciato Moka shine / Moka shine painted  
Ø40,3 H46,3  
Ø60,3 H36,8



Tuft tavolini / occasional tables  
 Verniciato Moka shine / Moka shine  
 painted  
 L/W40,3 P/D40,3 H46,3  
 L/W60,3 P/D60,3 H36,8

Tuft tavolini / occasional tables  
 Struttura verniciato Moka shine, piano  
 laccato opaco Cuoio / Structure Moka  
 shine painted  
 L/W60,3 P/D60,3 H36,8

Tuft tavolini / occasional tables  
 Struttura laccato opaco Petrolio, Piano  
 laccato opaco Tè verde / Structure matt  
 Petrolio lacquer, Top matt Tè verde lacquer  
 L/W40,3 P/D40,3 H46,3

Tuft tavolini / occasional tables  
 Struttura verniciato Bianco, Piano Laminam  
 Fokos Sale / Structure Bianco painted, Top  
 Laminam Fokos Sale  
 L/W40,3 P/D40,3 H46,3



Tuft tavolini / occasional tables  
Struttura laccato opaco Petrolio,  
Piano laccato opaco Tè verde /  
Structure matt Petrolio lacquer, Top  
matt Tè verde lacquer  
L/W40,3 P/D40,3 H46,3

Tuft tavolini / occasional tables  
Struttura verniciato Bianco, Piano  
Laminam Fokos Sale / Structure Bianco  
painted, Top Laminam Fokos Sale  
L/W40,3 P/D40,3 H46,3

## TUFT

design Enrico Cesana

Tuft è un tavolino rotondo con struttura in metallo disponibile in 2 misure. La parte superiore è realizzata come un "vassoio" a cui può essere abbinato un piano in legno o ceramica.

**Materiali e finiture**  
Struttura: Verniciato bianco o Moka shine, Laccati opachi, Laccati micalizzati.  
Inserto piano: Fashion wood, Laccati opachi, Laccati micalizzati, Ceramiche.

Tuft is a round occasional table with a metal structure available in 2 sizes. The top is made like a "tray", which can be combined with a wooden or ceramic surface.

**Materials and finishes**  
Structure: Bianco or Moka shine painted, Matt lacquers, Micalised lacquers.  
Top insert: Fashion wood, Matt lacquers, Micalised lacquers, Ceramics.

### Tavolini / Occasional tables

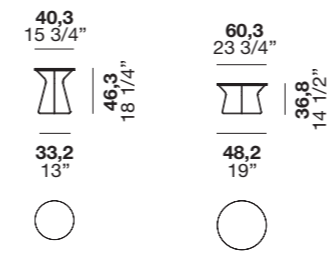

### Ceramiche per piano / Top ceramics

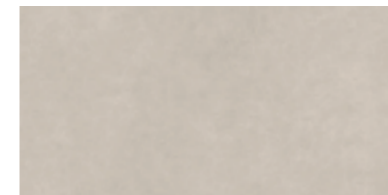

Laminam Fokos Sale

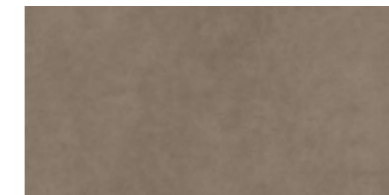

Laminam Fokos Terra

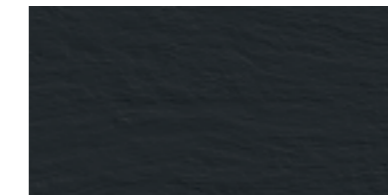

Laminam Ardesia a Spacco

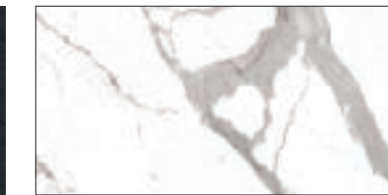

Laminam bianco Statuario Venato Lucidato

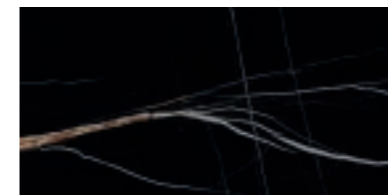

Laminam Sahara Noir Extra Lucidato



Neolith Himalaya Crystal Ultrasoft

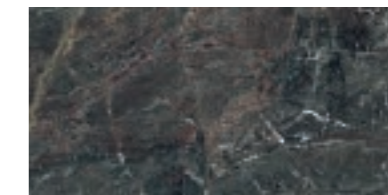

Neolith Amazonico Polished

# Wok

Colore, simpatia e versatilità: questa è la ricetta di Wok, un piccolo tavolino in metallo dalle grandi possibilità d'uso e ambientazione. Proposto in diversi colori, è pronto a inserirsi in qualsiasi ambiente contemporaneo.

Fun, versatile and packed with colour: this is the recipe for Wok, a small metal occasional table you can use in myriad ways and settings. Available in different colours, it fits well in any contemporary space.

design Enrico Cesana

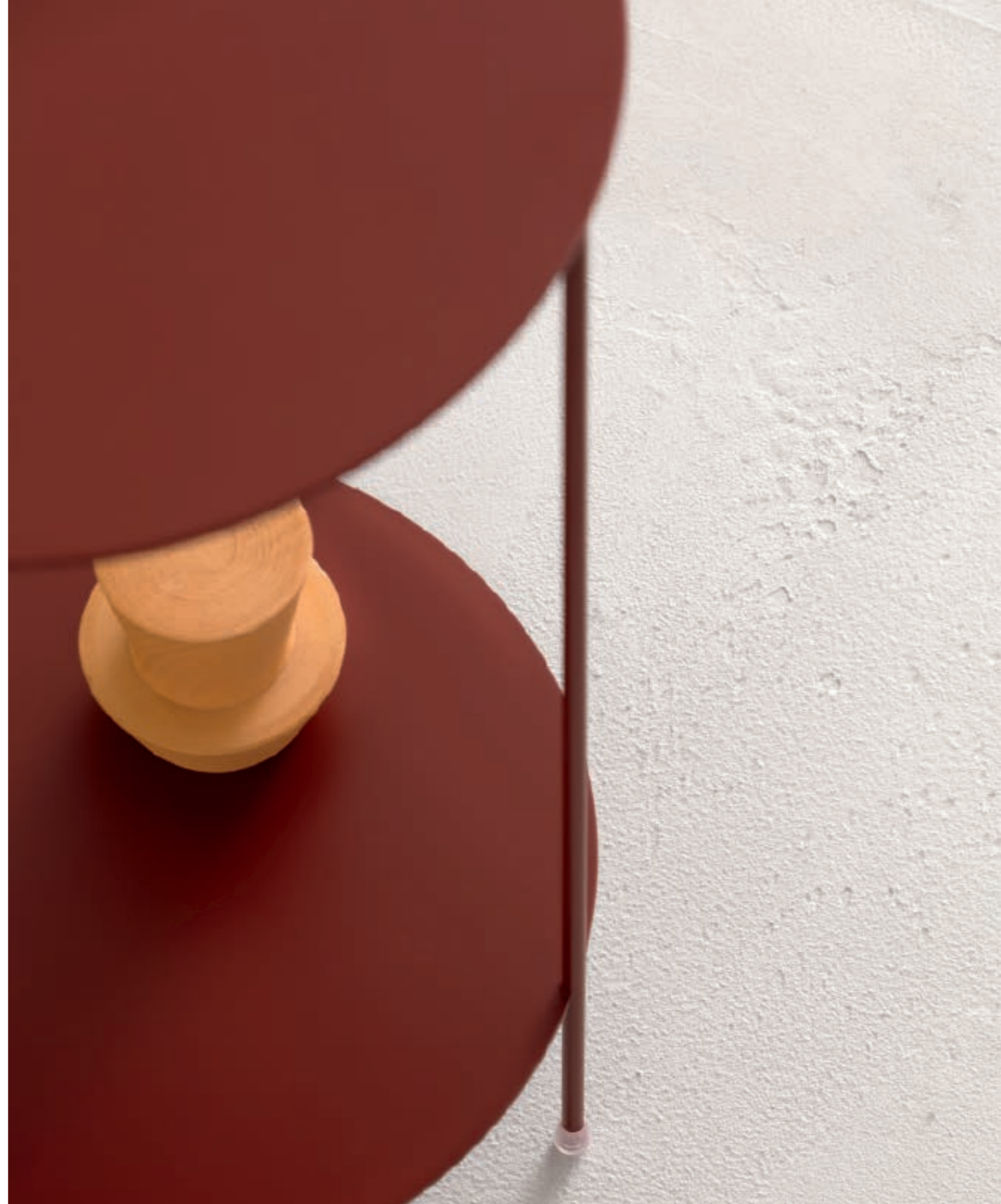



**Wok** tavolino / occasional table  
Laccato opaco Tortora/ Matte lacquer  
Tortora  
L/W27,5 P/D27,5 H50

**Wok** tavolino / occasional table  
Laccato opaco Amaranto/ Amaranto matte  
lacquer  
L/W27,5 P/D27,5 H50

**Rim** tavolino / occasional table  
Fashion wood Canapa e laccato opaco  
Tortora/ Fashion wood Canapa and matte  
lacquer Tortora  
L/W40 P/D40 H52

## WOK

design Enrico Cesana

Wok è un tavolino rotondo con struttura in metallo.

Wok is a round occasional table with a metal structure.

**Materiali e finiture**  
Struttura: Verniciato bianco o Moka shine,  
Laccati opachi, Laccati micalizzati.

**Materials and finishes**  
Structure: Bianco or Moka shine painted,  
Matt lacquers, Micalised lacquers.

Tavolino / Occasional table

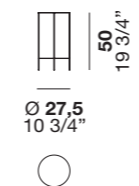

# Norman

Norman non è solo un pratico tavolino per l'ambiente living, ma svolge anche la funzione di contenitore con vani a giorno. Proposto in due dimensioni, può abbinare diversi materiali e colori, intonandosi con ogni progetto d'interni.

Norman is more than just a practical occasional table for your living room – it also serves as a storage unit with open compartments. Combine different materials and colours to match any interior design. Available in two sizes.

design Haften Studio





Norman tavolino / occasional table  
 Fashion wood Rovere Carbone /  
 Fashion wood Carbone oak  
 L/W100 P/D100 H33,6

## NORMAN

design Haften Studio

Norman è un tavolino con struttura in legno disponibile in versione quadrata o rettangolare. Il suo design si caratterizza per l'inserito piano in contrasto.

### Materiali e finiture

Struttura: Nobilitati, Fashion wood, Roveri laccati opachi, Laccati opachi, Laccati micalizzati.

Inserito piano: Nobilitati, Fashion wood, Roveri laccati opachi, Laccati opachi e lucidi, Laccati micalizzati.

The Norman occasional table has a wooden frame and it is available in either the square or the rectangular version. Its design stands out for the contrasting top insert.

### Materials and finishes

Structure: Surfaced, Fashion wood, Oak matt colours, Matt lacquers, Micalised lacquers.

Top insert: Surfaced, Fashion wood, Oak matt colours, Matt or High gloss lacquers, Micalised lacquers.

### Tavolini / Occasional tables

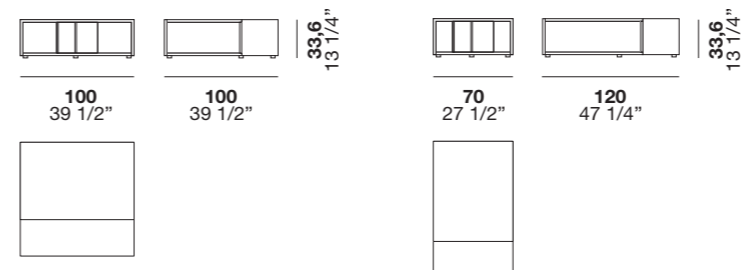

# Relief

Il segno grafico di questo tappeto è dato dal gioco di due tessiture diverse che, combinate con l'effetto vibrante della viscosa e la lavorazione a mano eseguita negli antichi telai indiani, ne danno un sapore caldo e contemporaneo.

The graphic markings of this rug come from the play of two different types of weaving which, combined with the shimmering effect of viscose and the hand working on ancient Indian looms, give it a warm, contemporary flavour.

design Bruna Vaccher



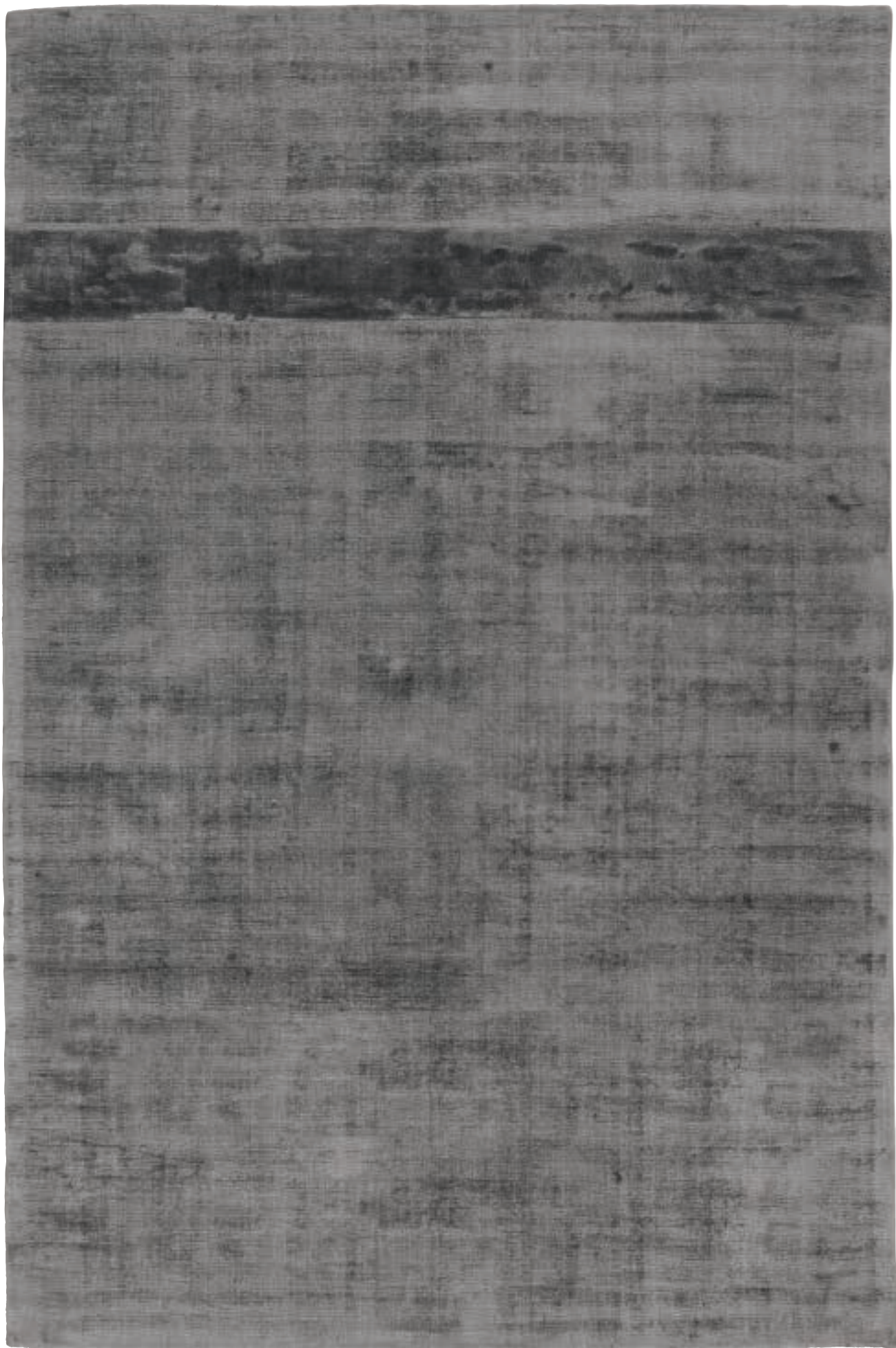

## RELIEF

design Bruna Vaccher

Tappeto Relief: le proprietà brillanti della viscosa di bamboo sono utilizzate al meglio in questo esercizio di tessitura manuale contemporanea. Il volume di questa tessitura, ottenuto dai telai antichi ancora disponibili in India, risulta essere compatto, seducente e vibrante alla luce.

Relief rug: this contemporary hand-woven piece boasts a shiny finish created by the bamboo viscose material. The weave was created using ancient looms still found in India and is both compact and seductive, glimmering in the light.

Materiali e finiture  
Viscosa

Materials and finishes  
Viscose

Tappeto / Rug

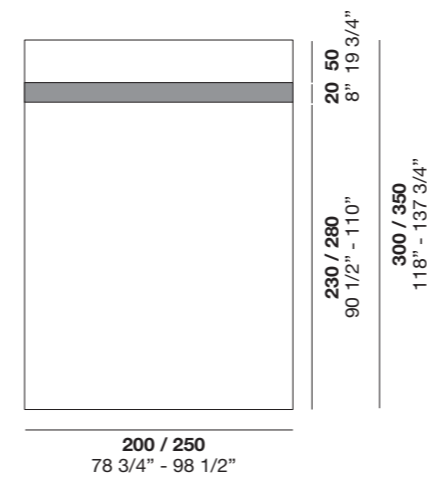

Colori disponibili / Available colours



Sabbia



Terra



Pietra

# The Italian Home

Una casa dove sistemi, complementi e persone vivono in armonia. Questo è il pensiero chiave di ricerca e sviluppo dei nuovi cataloghi complementi in cui Alf DaFrè ha definito i temi indispensabili del nuovo progettare l'arredo contemporaneo. Personalizzazione, produzione rispettosa dell'ambiente, design ricercato dal punto di vista estetico e funzionale in linea con i nuovi stili e tendenze dell'abitare contemporaneo.

A home where interiors, furniture and people are in harmony. This is the key logic behind research and development for the new catalogues of interiors, in which Alf DaFrè has clearly set out the fundamentals of a new path for contemporary furniture design. Customisation, manufacturing with respect for the environment, refined design in terms of form and function, aligned with new styles and trends in contemporary living.



Alf DaFrè: due nomi che narrano le vite di due giovani italiani cresciuti nel secondo dopoguerra. Alf è Oliviero, carismatico e solare, non ancora maggiorenne quando nel 1957 diventa socio della cooperativa Artigiana Legno Francenigo (Alf). Viaggiando prima per l'Italia e poi nel mondo, in 50 anni renderà Alf uno dei principali produttori di mobili in Italia. DaFrè è Rovilio, severo e ambizioso, appena ventunenne quando nel 1955 fonda il mobilificio DaFrè. Maniaco del dettaglio e amante del design, porterà DaFrè ad essere un marchio riconosciuto per qualità e design. Nel 2008 nasce Alf DaFrè: il talento imprenditoriale di Oliviero si unisce alla ricerca senza compromessi di Rovilio, il sapere industriale Alf si unisce all'anima sartoriale DaFrè per creare sistemi e complementi in armonia con gli ambienti e le persone che li vivono.



## Due nomi, due volti



### TWO NAMES, TWO FACES

Alf DaFrè: two names telling the stories of two young Italians growing up in the wake of the Second World War. Alf is Oliviero, cheerful and charismatic, and still just a teenager in 1957 when he became a member of the Artigiana Legno Francenigo (Alf) cooperative. Travelling first in Italy and then around the world, over 50 years he made Alf one of Italy's leading furniture producers. DaFrè is Rovilio, a serious and ambitious character, who founded the DaFrè furniture business in 1955, aged just 21. Obsessed with detail and passionate about design, he transformed DaFrè from unknown brand to symbol of quality and design.

In 2008 Alf DaFrè was born, as the entrepreneurial talent of Oliviero met the uncompromising innovation of Rovilio, and the industrial expertise of Alf met the sartorial spirit of DaFrè, creating interiors and furniture truly in harmony with their surroundings and the people who live in them.

## Le persone

Maria Cristina Piovesana, Piero Piovesana e Flavio Da Frè guidano oggi Alf DaFrè, un'azienda nella quale la tradizione familiare ed i valori umani sono i veri patrimoni. In Alf DaFrè ogni mattina inizia con un buongiorno, a prescindere dagli attriti della sera precedente o dalle discussioni a venire. Una tradizione iniziata da Oliviero Piovesana e che prosegue tuttora, simbolo di un approccio affabile e gentile, per ricreare un senso di comunità che trascenda i rapporti professionali.

### PEOPLE

Maria Cristina Piovesana, Piero Piovesana and Flavio Da Frè are now at the helm of Alf DaFrè, a company where family tradition and human values are considered the true assets. Every morning at Alf DaFrè must start with a "Good Morning", whatever quibbles there may have been the evening before or disagreements may be to come. This is a tradition introduced by Oliviero Piovesana that continues today; symbolic of a kind and pleasant approach, nurturing a sense of community that transcends professional relationships.

## Il territorio

Alf DaFrè ha da oltre 70 anni sede nella provincia di Treviso, al confine tra Friuli e Veneto. Un territorio dove l'abbondante legno, trasportato via acqua e lavorato grazie alla forza motrice delle rogge, ha creato i presupposti per la nascita di una tradizione ebanista che prosegue oggi in Alf DaFrè. Un legame indissolubile con un territorio fatto da persone, scandito dall'alternarsi di Ville Venete, casali di campagna e centri abitati dai tratti veneziani. Un microcosmo di bellezza ed eleganza da cui Alf DaFrè trae continuamente ispirazione e che traspare in ogni suo prodotto e dettaglio.



### THE LOCAL AREA

Alf DaFrè has been based in the province of Treviso (Italy), on the border between the Friuli and Veneto regions, for more than 70 years. Wood supplies are plentiful in this area, with the material being transported by water and worked thanks to the driving force of the man-made waterways, which has created the prerequisites for a cabinetmaking tradition that continues today at Alf DaFrè. There's an unbreakable bond between the company and the local area, made up of people, Palladian Veneto villas, country farmhouses, and residential areas with a Venetian flavour. It's a microcosm of beauty and elegance, from which Alf DaFrè draws continuous inspiration, and which permeates every product design and detail.



### PRODUCTION

Over 150,000 square metres of production space, where artisan expertise and the combined efforts of a close-knit and highly motivated team come together to create unique interiors and furniture, made by people for people. Investment in people and innovative manufacturing technology. For over a decade, Alf DaFrè has implemented a policy of investment in 4.0 manufacturing systems, combining the productivity and flexibility of a modern company with the care and skilful touch of artisan expertise.

## La produzione

Oltre 150.000 mq di spazi produttivi dove, dall'esperienza artigianale e dal lavoro di gruppo delle persone unite e motivate, nascono sistemi e complementi unici, fatti da persone per le persone. Investimenti nelle persone e nell'innovazione tecnologica produttiva. Da oltre un decennio Alf DaFrè promuove una politica d'investimento in impianti produttivi 4.0, coniugando produttività e flessibilità di un'azienda moderna con la cura e la mano invisibile del saper fare artigianale.

# Sustainability

## Impresa come valorizzazione del territorio



Alf DaFrè ha ampliato i suoi stabilimenti e continua il suo piano di sviluppo nel rispetto dell'ambiente, valutando i suoi impatti ambientali, realizzando un progetto sostenibile con la consapevolezza di essere attore in un sistema in cui capitale naturale e capitale umano devono essere preservati e valorizzati per le generazioni future e per l'intera comunità. Nei piani di sviluppo viene sempre messo in sicurezza idrogeologica il territorio in cui Alf DaFrè opera, proteggendolo dagli allagamenti e tutelando l'ecosistema locale.

### A COMPANY WORKING WITH ITS SURROUNDINGS

Alf DaFrè has expanded its production sites and is moving forward with its development plan with respect for the environment, establishing a sustainable project, aware of its role in a system where natural capital and human capital must be safeguarded and promoted for future generations and the community as a whole. Development plans all include attention to the hydrogeological stability of the area in which Alf DaFrè operates, protecting it from flooding and preserving the local ecosystem.

La sostenibilità come un insieme di azioni che Alf DaFrè realizza attraverso una costante razionalizzazione dei processi e delle utenze, incrementando l'efficienza degli impianti che si traduce in un aumento della produttività a parità di consumo energetico. Oltre a controllare le emissioni in atmosfera, Alf DaFrè limita e riduce costantemente le esternalità attraverso azioni chiare e mirate. Vengono internalizzate le lavorazioni per ridurre il traffico su strada e si ottimizza la viabilità per l'accesso ai propri stabilimenti.

## Sostenibilità come razionalizzazione



### SUSTAINABILITY AS RATIONALISATION

Sustainability is managed as a set of actions implemented by Alf DaFrè through continuous rationalisation of processes and utilities, increasing the efficiency of systems, which translates into increased productivity with equal energy consumption. In addition to controlling atmospheric emissions, Alf DaFrè constantly limits and reduces outsourcing through clear and targeted measures. Processing is performed inhouse to reduce road transport and the road network leading to its sites has been optimised.

Alf DaFrè opera una costante ricerca per fornire materiali di altissima qualità, prediligendo l'uso di finiture all'acqua e materiali ecologici. I pannelli impiegati sono a bassa emissione di VOC e formaldeide secondo le normative EPA e CARB. Una qualità che mira a fornire prodotti che rispettino un principio cardine della sostenibilità, ovvero la durabilità nel tempo. L'attenzione verso i materiali è anche posta alla fase di raccolta differenziata, recupero e riutilizzo di questi, riciclandoli e ottimizzando gli imballaggi.



## Costante ricerca nei materiali

### CONSTANT RESEARCH INTO MATERIALS

Alf DaFrè carries out constant research in order to offer extremely high-quality materials, prioritising the use of water-based finishes and eco-friendly materials. The panels used have low VOC and formaldehyde emissions as per EPA and CARB regulations. The company strives for quality, enabling products aligned with a core principle of sustainability: durability. Focus is also placed on materials with a view to their separate processing on disposal, enabling their recovery and reuse, and the recycling and optimisation of packaging.

## Benessere e valorizzazione delle persone



Per Alf DaFrè il benessere e la valorizzazione delle persone sono principi fondamentali verso il capitale umano. Per questo è stato stilato un Codice Etico che stabilisce i valori e i comportamenti sui quali si fondano le attività e i rapporti con dipendenti e collaboratori: per lavorare bene, in un mondo migliore.

### WELLBEING AND PROMOTION OF HUMAN RESOURCES

At Alf DaFrè, ensuring the wellbeing of employees and promoting professional development are key principles in our approach to human capital. This is why a Code of Ethics has been established, setting out the values and conduct which forms the basis of the business and relationships with employees and partners: working well together, for a better world.

# Alf DaFre®

ALF UNO Spa  
Via S. Pio X 17  
31018 Francenigo di Gaiarine  
Treviso, Italy  
Tel. +39 0438 997111  
Fax Italia +39 0438 997245  
Fax estero +39 0438 997246  
www.alfdafre.it alf@alf.it



ALF UNO Spa  
è certificata ISO 9001:2015  
ALF UNO Spa  
is certified by the ISO 9001:2015

Verifica le finiture disponibili sul nostro sito internet / Check the finishes available on our website [www.alfdafre.it](http://www.alfdafre.it)

ALF UNO s.p.a. si riserva di apportare in qualsiasi momento modifiche a prodotti, misure e materiali, che ritenesse utili per esigenze di carattere produttivo e commerciale. Per essere sempre aggiornati vi invitiamo a consultare il nostro sito internet [www.alfdafre.it](http://www.alfdafre.it). LE FINITURE: I materiali utilizzati dalla nostra azienda sono selezionati tra i più affidabili per applicazione e resa estetica. Nonostante questo devono considerarsi tollerabili alcune differenze dovute alle caratteristiche stesse di materiali come essenze naturali, vetri, laccature e all'artigianalità di alcune fasi del processo produttivo che da sempre è un nostro valore aggiunto. Inoltre alcune finiture possono subire nel tempo maturazioni dovute all'azione della luce e del tempo. È importante quindi specificare se nell'ordine vi sono sostituzioni o completamenti per valutare insieme il miglior modo di procedere. Le tonalità di colore e le finiture illustrate vanno considerate puramente indicative. Verificare sempre la fattibilità dell'abbinamento finiture consultando l'interno del listino.

ALF UNO s.p.a. reserves the right to make any changes to products, measurements and materials at any time deemed useful for manufacturing and sales purposes. To stay up to date at all times, please visit our website [www.alfdafre.it](http://www.alfdafre.it). FINISHES: The materials we use are selected among the most reliable products in terms of application and aesthetic rendering. Despite this, certain differences due to the very characteristics of materials such as natural wood finishes, glass and lacquers must be considered tolerable, as well as the hand-crafted nature of certain phases of the production process, which has always been one of our added values. In addition, some finishes may change over time, due to the effects of light and time. It is therefore important to specify whether there are replacements or completions in the order to assess the best way to proceed together. The finishes featured in this sample collection are purely indicative and are not available for all products. Please check in the price list if the finish is available for the chosen item. Orders will not be accepted for products with finishes not included in the price list. The colour shades and finishes illustrated herein are to be considered purely indicative. Always check the feasibility of finish combinations by consulting the price list contents.

art direction **Bruna Vaccher, Genny Canton** / graphic design **Genny Canton Studio** / photo **Paolo Contratti, Paolo Burato, Riccardo Munarin** / styling **Rosanna Bignucolo, Claudia Barberi** / digital image **Nudesign** / separations **Luce srl** / print **Sincromia**

thanks to **G.T.Design, Panzeri**