

LETTI / BEDS



**Alf DaFre<sup>®</sup>**

**LETTI / BEDS**

**Alf DaFre®**

# The Italian Home

Una casa dove sistemi, complementi e persone vivono in armonia. Questo è il pensiero chiave di ricerca e sviluppo del nuovo catalogo letti, in cui Alf DaFrè esplora il tema della notte attraverso un design capace di coniugare comfort, stile e innovazione. La collezione propone forme raffinate, materiali selezionati e dettagli curati che riflettono le nuove esigenze dell'abitare contemporaneo. L'ampia possibilità di personalizzazione e la perfetta integrazione tra finiture consentono accostamenti cromatici coerenti con gli altri elementi e sistemi della casa, contribuendo a creare ambienti armonici, fluidi e su misura.

A home where systems, complements and people live in harmony. This is the key concept behind the research and development of the new beds catalogue, where Alf DaFrè explores the theme of night through a design that blends comfort, style and innovation. The collection features refined shapes, carefully selected materials and meticulous details that reflect the evolving needs of contemporary living. A wide range of customisation options and the seamless integration of finishes allow for consistent colour combinations with other elements and systems in the home, helping to create harmonious, fluid and tailor-made interiors.



Alf DaFrè: due nomi che narrano le vite di due giovani italiani cresciuti nel secondo dopoguerra. Alf è Oliviero, carismatico e solare, non ancora maggiorenne quando nel 1957 diventa socio della cooperativa Artigiana Legno Francenigo (Alf). Viaggiando prima per l'Italia e poi nel mondo, in 50 anni renderà Alf uno dei principali produttori di mobili in Italia. Da Frè è Rovilio, severo e ambizioso, appena ventunenne quando nel 1955 fonda il mobilificio DaFrè. Maniacco del dettaglio e amante del design, porterà DaFrè ad essere un marchio riconosciuto per qualità e design. Nel 2008 nasce Alf DaFrè: il talento imprenditoriale di Oliviero si unisce alla ricerca senza compromessi di Rovilio, il sapere industriale Alf si unisce all'anima sartoriale DaFrè per creare sistemi e complementi in armonia con gli ambienti e le persone che li vivono.



## Due nomi, due volti



### TWO NAMES, TWO FACES

Alf DaFrè: two names telling the stories of two young Italians growing up in the wake of the Second World War. Alf is Oliviero, cheerful and charismatic, and still just a teenager in 1957 when he became a member of the Artigiana Legno Francenigo (Alf) cooperative. Travelling first in Italy and then around the world, over 50 years he made Alf one of Italy's leading furniture producers. Da Frè is Rovilio, a serious and ambitious character, who founded the DaFrè furniture business in 1955, aged just 21. Obsessed with detail and passionate about design, he transformed DaFrè from unknown brand to symbol of quality and design.

In 2008 Alf DaFrè was born, as the entrepreneurial talent of Oliviero met the uncompromising innovation of Rovilio, and the industrial expertise of Alf met the sartorial spirit of DaFrè, creating interiors and furniture truly in harmony with their surroundings and the people who live in them.

## Le persone

Maria Cristina Piovesana, Piero Piovesana e Flavio Da Frè guidano oggi Alf DaFrè, un'azienda nella quale la tradizione familiare ed i valori umani sono i veri patrimoni. In Alf DaFrè ogni mattina inizia con un buongiorno, a prescindere dagli attriti della sera precedente o dalle discussioni a venire. Una tradizione iniziata da Oliviero Piovesana e che prosegue tuttora, simbolo di un approccio affabile e gentile, per ricreare un senso di comunità che trascenda i rapporti professionali.

### PEOPLE

Maria Cristina Piovesana, Piero Piovesana and Flavio Da Frè are now at the helm of Alf DaFrè, a company where family tradition and human values are considered the true assets. Every morning at Alf DaFrè must start with a "Good Morning", whatever quibbles there may have been the evening before or disagreements may be to come. This is a tradition introduced by Oliviero Piovesana that continues today; symbolic of a kind and pleasant approach, nurturing a sense of community that transcends professional relationships.

## Il territorio

Alf DaFrè ha da oltre 70 anni sede nella provincia di Treviso, al confine tra Friuli e Veneto. Un territorio dove l'abbondante legno, trasportato via acqua e lavorato grazie alla forza motrice delle rogge, ha creato i presupposti per la nascita di una tradizione ebanista che prosegue oggi in Alf DaFrè. Un legame indissolubile con un territorio fatto da persone, scandito dall'alternarsi di Ville Venete, casali di campagna e centri abitati dai tratti veneziani. Un microcosmo di bellezza ed eleganza da cui Alf DaFrè trae continuamente ispirazione e che traspare in ogni suo prodotto e dettaglio.



### THE LOCAL AREA

Alf DaFrè has been based in the province of Treviso (Italy), on the border between the Friuli and Veneto regions, for more than 70 years. Wood supplies are plentiful in this area, with the material being transported by water and worked thanks to the driving force of the man-made waterways, which has created the prerequisites for a cabinetmaking tradition that continues today at Alf DaFrè. There's an unbreakable bond between the company and the local area, made up of people, Palladian Veneto villas, country farmhouses, and residential areas with a Venetian flavour. It's a microcosm of beauty and elegance, from which Alf DaFrè draws continuous inspiration, and which permeates every product design and detail.



### PRODUCTION

Over 150,000 square metres of production space, where artisan expertise and the combined efforts of a close-knit and highly motivated team come together to create unique interiors and furniture, made by people for people. Investment in people and innovative manufacturing technology. For over a decade, Alf DaFrè has implemented a policy of investment in 4.0 manufacturing systems, combining the productivity and flexibility of a modern company with the care and skilful touch of artisan expertise.

## La produzione

Oltre 150.000 mq di spazi produttivi dove, dall'esperienza artigianale e dal lavoro di gruppo delle persone unite e motivate, nascono sistemi e complementi unici, fatti da persone per le persone. Investimenti nelle persone e nell'innovazione tecnologica produttiva. Da oltre un decennio Alf DaFrè promuove una politica d'investimento in impianti produttivi 4.0, coniugando produttività e flessibilità di un'azienda moderna con la cura e la mano invisibile del saper fare artigianale.

# Sustainability

## Impresa come valorizzazione del territorio



Alf DaFrè ha ampliato i suoi stabilimenti e continua il suo piano di sviluppo nel rispetto dell'ambiente, valutando i suoi impatti ambientali, realizzando un progetto sostenibile con la consapevolezza di essere attore in un sistema in cui capitale naturale e capitale umano devono essere preservati e valorizzati per le generazioni future e per l'intera comunità. Nei piani di sviluppo viene sempre messo in sicurezza idrogeologica il territorio in cui Alf DaFrè opera, proteggendolo dagli allagamenti e tutelando l'ecosistema locale.

**A COMPANY WORKING WITH ITS SURROUNDINGS**  
Alf DaFrè has expanded its production sites and is moving forward with its development plan with respect for the environment, establishing a sustainable project, aware of its role in a system where natural capital and human capital must be safeguarded and promoted for future generations and the community as a whole. Development plans all include attention to the hydrogeological stability of the area in which Alf DaFrè operates, protecting it from flooding and preserving the local ecosystem.

La sostenibilità come un insieme di azioni che Alf DaFrè realizza attraverso una costante razionalizzazione dei processi e delle utenze, incrementando l'efficienza degli impianti che si traduce in un aumento della produttività a parità di consumo energetico. Oltre a controllare le emissioni in atmosfera, Alf DaFrè limita e riduce costantemente le esternalità attraverso azioni chiare e mirate. Vengono internalizzate le lavorazioni per ridurre il traffico su strada e si ottimizza la viabilità per l'accesso ai propri stabilimenti.

## Sostenibilità come razionalizzazione



**SUSTAINABILITY AS RATIONALISATION**  
Sustainability is managed as a set of actions implemented by Alf DaFrè through continuous rationalisation of processes and utilities, increasing the efficiency of systems, which translates into increased productivity with equal energy consumption. In addition to controlling atmospheric emissions, Alf DaFrè constantly limits and reduces outsourcing through clear and targeted measures. Processing is performed inhouse to reduce road transport and the road network leading to its sites has been optimised.

Alf DaFrè opera una costante ricerca per fornire materiali di altissima qualità, prediligendo l'uso di finiture all'acqua e materiali ecologici. I pannelli impiegati sono a bassa emissione di VOC e formaldeide secondo le normative EPA e CARB. Una qualità che mira a fornire prodotti che rispettino un principio cardine della sostenibilità, ovvero la durabilità nel tempo. L'attenzione verso i materiali è anche posta alla fase di raccolta differenziata, recupero e riutilizzo di questi, riciclandoli e ottimizzando gli imballaggi.



## Costante ricerca nei materiali

### CONSTANT RESEARCH INTO MATERIALS

Alf DaFrè carries out constant research in order to offer extremely high-quality materials, prioritising the use of water-based finishes and eco-friendly materials. The panels used have low VOC and formaldehyde emissions as per EPA and CARB regulations. The company strives for quality, enabling products aligned with a core principle of sustainability: durability. Focus is also placed on materials with a view to their separate processing on disposal, enabling their recovery and reuse, and the recycling and optimisation of packaging.

## Benessere e valorizzazione delle persone



Per Alf DaFrè il benessere e la valorizzazione delle persone sono principi fondamentali verso il capitale umano. Per questo è stato stilato un Codice Etico che stabilisce i valori e i comportamenti sui quali si fondano le attività e i rapporti con dipendenti e collaboratori: per lavorare bene, in un mondo migliore.

### WELLBEING AND PROMOTION OF HUMAN RESOURCES

At Alf DaFrè, ensuring the wellbeing of employees and promoting professional development are key principles in our approach to human capital. This is why a Code of Ethics has been established, setting out the values and conduct which forms the basis of the business and relationships with employees and partners: working well together, for a better world.

# Index

## Imbottiti / Upholstered



ALLEN 2  
pag. 196



ARTUR  
pag. 170



ATLAS  
pag. 114



BELLATRIX  
pag. 188



CASSIOPEA  
pag. 152



HUG  
pag. 122



JETTY 2  
pag. 104



MILANO 2  
pag. 072



MIRAM  
pag. 160



MORRISON 2  
pag. 130



NEYO  
pag. 094



OREGON 2  
pag. 180



ORION  
pag. 142



YUME  
pag. 082

## Legno / Wood



DORIAN 2  
pag. 204



ECATE  
pag. 212



GRAND VOILE  
pag. 040



LEVANTE  
pag. 056



PAAL  
pag. 026



RIGHETTO  
pag. 064



ROVI  
pag. 014



TEO 2  
pag. 222



VOILE  
pag. 050



XILO 2  
pag. 232

## Componibili / Modular



SUITE SYSTEM 2  
pag. 246

## Materassi /Mattresses

pag. 290

## Complementi / Complements

pag. 292

# Rovì

Rovì è la riedizione esclusiva di un letto iconico degli anni '70 firmato Rovilio Da Frè, simbolo di un design senza tempo che unisce artigianalità e innovazione. Rovì si distingue per una struttura sinuosa ed elegante, realizzata in rovere massello con giunti a pettine, dettaglio distintivo di grande raffinatezza. Il rivestimento della testiera, disponibile in cuoio, tessuto o pelle, offre ampie possibilità di personalizzazione, valorizzando l'estetica e il comfort del progetto.

Rovì is the exclusive reissue of an iconic 1970s bed designed by Rovilio Da Frè, a symbol of timeless design that combines craftsmanship and innovation. Rovì stands out for its sleek and elegant silhouette, crafted from solid oak with dovetail joints — a distinctive detail of great refinement. The headboard upholstery, available in leather, fabric, or hide, offers extensive customization options, enhancing both the aesthetics and comfort of the design.

design R&D Alf DaFrè





**Rovi letto / bed**  
Fashion wood Rovere Naturale e Cuoio  
Cognac / Natural oak Fashion wood and  
Cognac leather  
L/W174 P/D225,7 H97,5

**Nadir gruppo notte / storage units**  
Laccato lucido Verde Foresta / High  
gloss Verde Foresta lacquer  
L/W160 P/D55,4 H79,6  
→ Cat. Storage units: Nadir p. 014

**Disco specchiera / mirror**  
Moka shine  
Ø96 P/D5,5





Rovi letto / bed  
Fashion wood Rovere Terra e Tessuto  
Taiga 01 90/3 / Terra oak Fashion wood  
and Taiga 01 90/3 Fabric  
L/W174 P/D225,7 H97,5

Nadir gruppo notte / storage units  
Laccato opaco Bordeaux / Matt  
Bordeaux lacquer  
L/W45 P/D45 H46,8  
L/W160 P/D55,4 H79,6  
→ Cat. Storage units: Nadir p. 014



**Rovi letto / bed**  
Fashion wood Rovere Terra / Terra oak  
Fashion wood  
L/W174 P/D225,7 H97,5

**Nadir gruppo notte / storage units**  
Laccato lucido Bordeaux / High Gloss  
Bordeaux lacquer  
L/W45 P/D45 H46,8  
→ Cat. Storage units: Nadir p. 014



Rovi letto / bed  
Fashion wood Rovere Naturale, Cuoio Cognac, Tessuto Taiga 01 90/3 / Natural oak Fashion wood and Cognac leather, Taiga 01 90/3 fabric  
L/W174 P/D225,7 H97,5

## ROVI

design R&D Alf DaFrè



Rovi è un letto con struttura in legno massello disponibile nelle finiture di Fashion Wood Alf DaFrè, caratterizzato da eleganti giunti in nickel sulla struttura che esaltano la qualità artigianale del progetto. La testiera può essere personalizzata e rivestita nelle finiture di cuoio, tessuto, pelle della collezione Alf DaFrè oppure nella versione totalmente in legno per un sapore più minimalista. La struttura, realizzata in legno di frassino naturale, può presentare variazioni cromatiche, espressione autentica dell'essenza del materiale.

Struttura Fashion Wood rovere massello  
Testiera rivestita nelle finiture di tessuti, cuoio e pelli Alf DaFrè.  
Struttura interna di supporto Nickel o Moka Shine.

Misure  
Measurements  
L 174 P 225,7 H 97,5

Rovi is a bed with a solid wood frame, available in the Fashion Wood finishes by Alf DaFrè, and characterized by elegant nickel joints on the structure that highlight the artisanal quality of the design. The headboard can be customized and upholstered in leather, fabric, or hide from the Alf DaFrè collection, or offered entirely in wood for a more minimalist aesthetic. The structure, made of natural ash wood, may show colour variations, which are an authentic expression of the essence of the material.

Structure: Fashion Wood in solid oak  
Headboard: Upholstered in Alf DaFrè fabrics, hide, or leathers.  
Internal support structure: Nickel or Moka Shine finish.

Vano rete  
Inner spring support size  
160,5 X 200,5

Testiera legno / Wood headboard

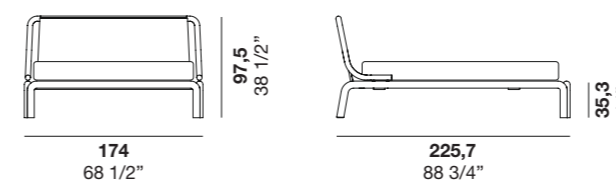

Testiera rivestita / Headboard upholstered

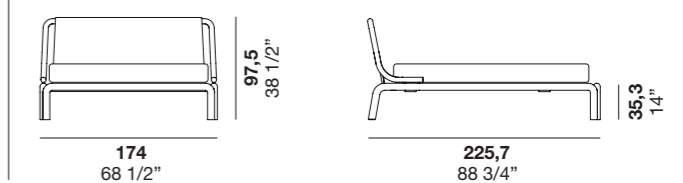

# Paal

Paal è un letto in legno caratterizzato da una struttura essenziale, impreziosita dalla caratteristica curvatura della testiera, disponibile in finitura Fashion Wood o laccata. Si distingue per la sua leggerezza visiva e per l'appoggio su gambe sagomate in legno, proposte nella ricca gamma di finiture Fashion Wood. La testiera curvata si appoggia direttamente sulle solide gambe, creando un dettaglio di incastro distintivo e raffinato, arricchito dal contrasto tra colori laccati e Fashion Wood.

Paal is a wooden bed characterized by a minimal structure, enhanced by the distinctive curved headboard, available in fashion wood or lacquered finishes. It stands out for its visual lightness and for the support on shaped wooden legs, offered in a rich range of Fashion Wood finishes. The curved headboard rests directly on the solid legs, creating a distinctive and refined interlocking detail, enriched by the contrast between lacquered colors and Fashion Wood.

design R&D Alf DaFrè







Paal letto / bed  
Fashion wood Rovere Biscotto e Laccato  
opaco Anfora / Biscotto oak Fashion  
wood and matt Anfora lacquer  
L/W172,6 P/D221,8 H100,5



Paal letto / bed  
Fashion wood Rovere Canapa / Canapa  
oak Fashion wood  
L/W172,6 P/D221,8 H100,5

Mei gruppo notte / storage units  
Laccato lucido-opaco Mocha Mousse /  
High gloss-matt Mocha Mousse lacquer  
L/W60 P/D46 H46  
→ Cat. Storage units: Mei p. 030



Paal letto / bed  
Fashion wood Rovere terra e laccato  
opaco Nude / Terra oak Fashion wood  
and Matt Nude lacquer  
L/W172,6 P/D221,8 H100,5

Mei gruppo notte / storage units  
Laccato opaco Nude / Matt  
Nude lacquer  
L/W60 P/D46 H46  
L/W130 P/D54 H75  
→ Cat. Storage units: Mei p. 030





## PAAL

design R&D Alf DaFrè



Paal è un letto in legno con la struttura della testiera curvata e il giroletto disponibili in finiture Fashion Wood e laccate che ne consentono l'ampia personalizzazione con ogni ambiente. Poggia su gambe in legno, caratterizzate dalla ricercata stonatura e personalizzabili nelle diverse finiture di Fashion Wood.

### Materiali e finiture

Testiera e struttura in Fashion Wood, laccato opaco, lucido o micalizzato. Gambe nelle diverse finiture di Fashion Wood

### Misure

Measurements

L172,6 P221,8 H100,5

Paal is a wooden bed featuring a curved headboard and bed frame, available in Fashion Wood and lacquered finishes that allow for extensive customization to suit any environment. It rests on wooden legs, characterized by refined rounding and customizable in the various Fashion Wood finishes.

### Materials and finishes

Headboard and structure in Fashion Wood, matte, glossy, or micalized lacquer. Legs available in a variety of Fashion Wood finishes.

### Vano rete

Inner spring support size

160,5 X 200,5

Legno / Wood

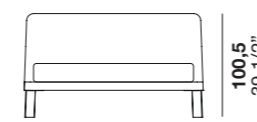

172,6  
68"

100,5  
39 1/2"

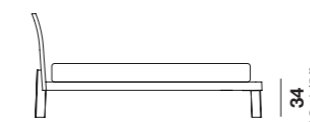

221,8  
87 1/4"

34  
13 1/2"

# Grand Voile

Grand Voile presenta un design che richiama un velo sospeso sulla notte, donando un'atmosfera di leggerezza ed eleganza. La testiera si trasforma in una scenografica boiserie che, arricchita da due cuscini, crea un'isola ideale per il riposo. Le mensole funzionali ne completano estetica e utilità.

Grand Voile features a design reminiscent of a veil suspended over the night, evoking an atmosphere of lightness and elegance. The headboard transforms into a scenic boiserie which, enhanced by two cushions, creates an ideal island for rest. Functional shelves complete its aesthetics and utility.

design R&D Alf DaFrè

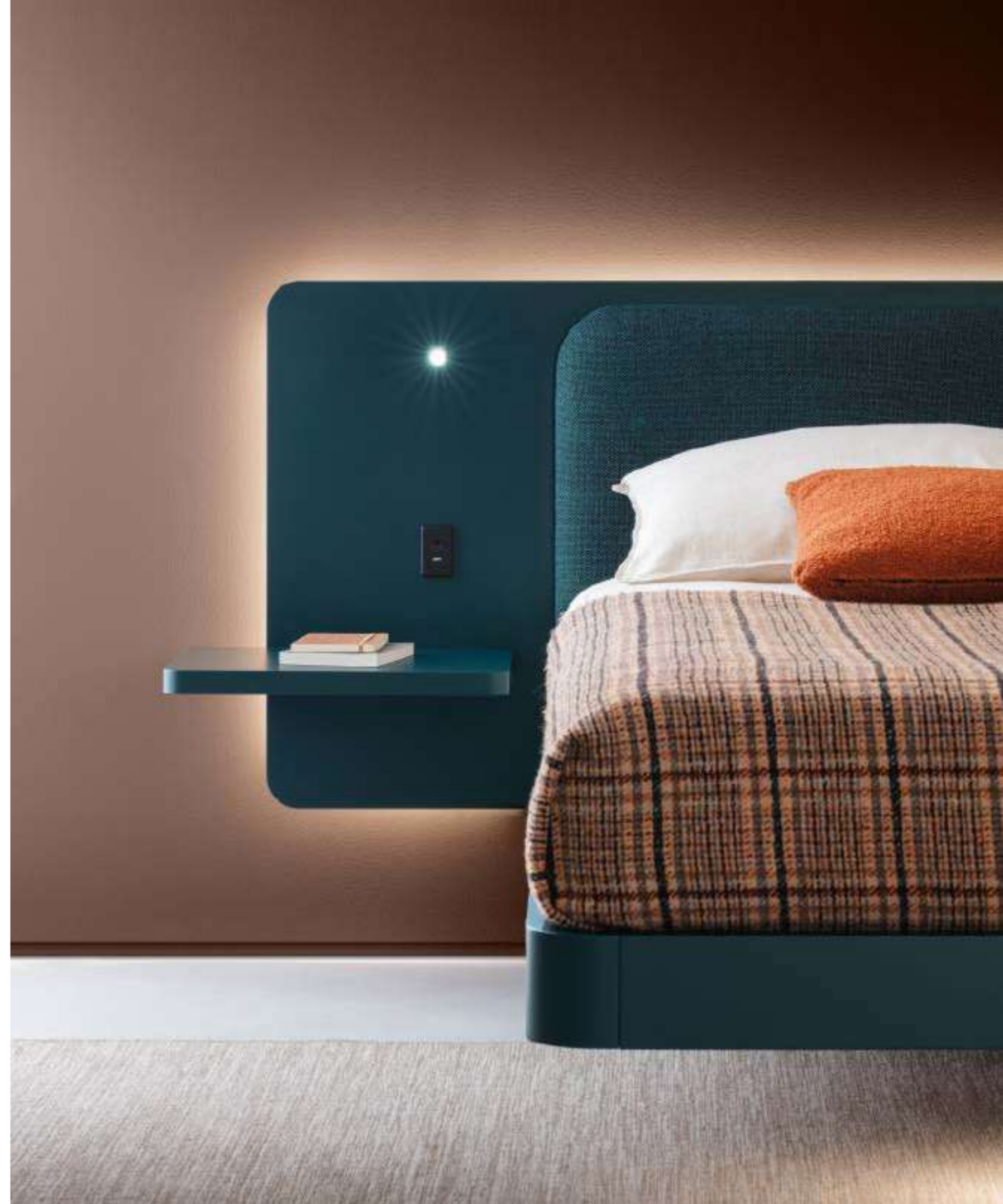



Grand Voile letto / bed  
Laccato opaco Blu notte e tessuto Taiga  
01 98/2 / Matt Blu notte lacquer and  
Taiga 01 98/2 Fabric  
L/W280 P/D216,5 H102,3

Mei gruppo notte / storage units  
Laccato opaco Nude / Matt  
Nude lacquer  
L/W130 P/D54 H75  
→ Cat. Storage units: Mei p. 030

Disco specchiera / mirror  
Verniciato Moka shine / Moka Shine painted  
Ø76,5 P/D5,5



046

Alf DaFrè



**Grand Voile** letto / bed  
Laccato opaco Blu notte e tessuto Taiga  
01 98/2 / Matt Blu notte lacquer and  
Taiga 01 98/2 Fabric  
L/W256 P/D216,5 H102,3

**Grand Voile**

**Nadir** gruppo notte / storage units  
Laccato opaco Blu notte / Matt Blu  
notte lacquer  
L/W45 P/D45 H46,8  
→ Cat. Storage units: Nadir p. 014

**Letti / Beds**

047



Grand Voile letto / bed  
Fashion wood Rovere Canapa e tessuto  
Please 503 / Canapa oak Fashion wood  
and Please 503 Fabric  
L/W280 P/D216,5 H102,3

Rim gruppo notte / storage unit  
Fashion wood Rovere Canapa /  
Canapa oak Fashion wood  
L/W40 P/D40 H52  
→ Cat. Storage units: Rim p. 188



1

2

3

1. Testiera con cuscini imbottiti e mensola / Headboard with padded cushions and shelf
2. Testiera con mensola / Headboard with shelf
3. Testiera / Headboard



1

2

3

1. Piattaforma P24 / P24 platform
2. Piattaforma P28 Fashion wood / P28 fashion wood platform
3. Piattaforma P28 laccato / P28 lacquered platform



1

2



3

4

1. Presa USB A / USB A socket
2. Luce orientabile / Adjustable light
3. Presa USB A+C / USB A+C socket
4. Telecomando luci letto / Bedside light remote control

# GRAND VOILE

design R&D Alf DaFrè



Grand Voile è un letto caratterizzato da una struttura sospesa, fissata a parete e sostenuta da un piede centrale. La testiera, che si trasforma in una boiserie, e la pediera possono essere illuminati con LED per creare un'atmosfera raffinata nella zona notte. La testiera è disponibile con o senza cuscini imbottiti e personalizzabile nella gamma di tessuti Alf DaFrè. Oltre alle mensole, è possibile aggiungere luci orientabili e una coppia di prese USB.

Grand Voile is a bed featuring a suspended structure fixed to the wall and supported by a central leg. The headboard, which transforms into a boiserie, and the footboard can be illuminated with LEDs to create a refined atmosphere in the bedroom. The headboard is available with or without upholstered cushions and can be customized with Alf DaFrè's fabric range. In addition to shelves, adjustable lights and a pair of USB outlets can be added.

**Materiali e finiture**  
Testiera e giroletto in Fashion Wood, laccato opaco, lucido o micalizzato e in nobilitato.  
Struttura nera in metallo.

**Materials and finishes**  
Headboard and bed frame in Fashion Wood, matte lacquer, high gloss lacquer, micaceous lacquer, or surfaced.  
Black metal structure.

**Misure**  
Measurements  
P28: L 236 / 256 / 266 / 276  
P 211 / 216,5  
H 102,3 / 112,3  
P24: L 236 / 256 / 266 / 276  
P 209,4 / 214,9  
H 102,3 / 112,3

**Vano rete**  
Inner spring support size  
P28: 140,5 X 202 / 207,5  
160,5 X 202 / 207,5  
170,5 X 202 / 207,5  
180,5 X 202 / 207,5  
P24: 140,5 X 200,5 / 206  
160,5 X 200,5 / 206  
170,5 X 200,5 / 206  
180,5 X 200,5 / 206

P28

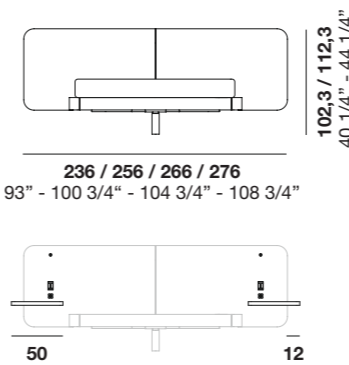

P24

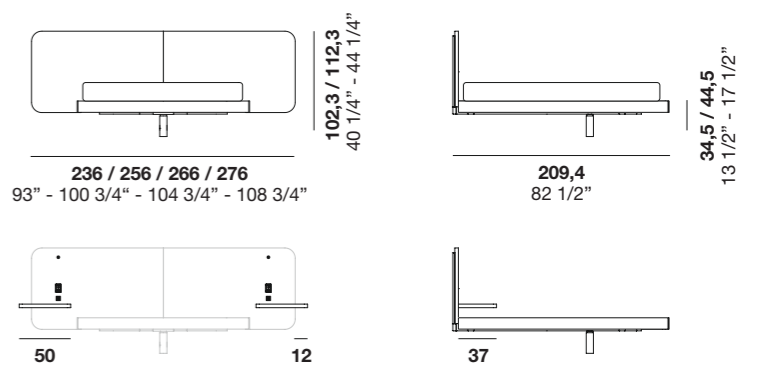

P28, testiera con cuscini / P28, headboard with cushions

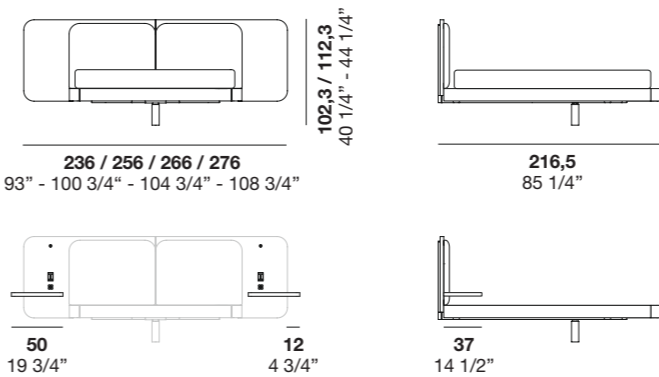

P24, testiera con cuscini / P24, headboard with cushions

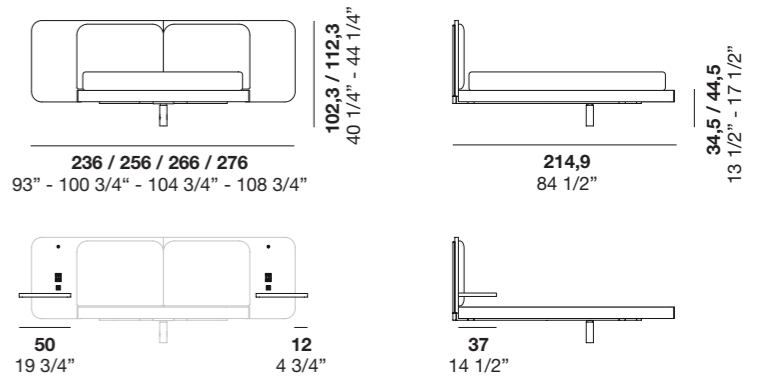

# Voile

Voile è l'opzione più essenziale, pensata con un'estetica pulita e minimale. Anche in questa versione, la testiera si trasforma in una boiserie decorativa e personalizzabile nelle finiture dei cuscini. Un design che unisce funzionalità ed eleganza, ideale per chi cerca semplicità senza rinunciare allo stile.

Voile is the most essential option, designed with a clean and minimal aesthetic. Even in this version, the headboard transforms into a decorative boiserie, customizable in the cushion finishes. A design that combines functionality and elegance, ideal for those who seek simplicity without sacrificing style.

design by R&D Alf DaFrè

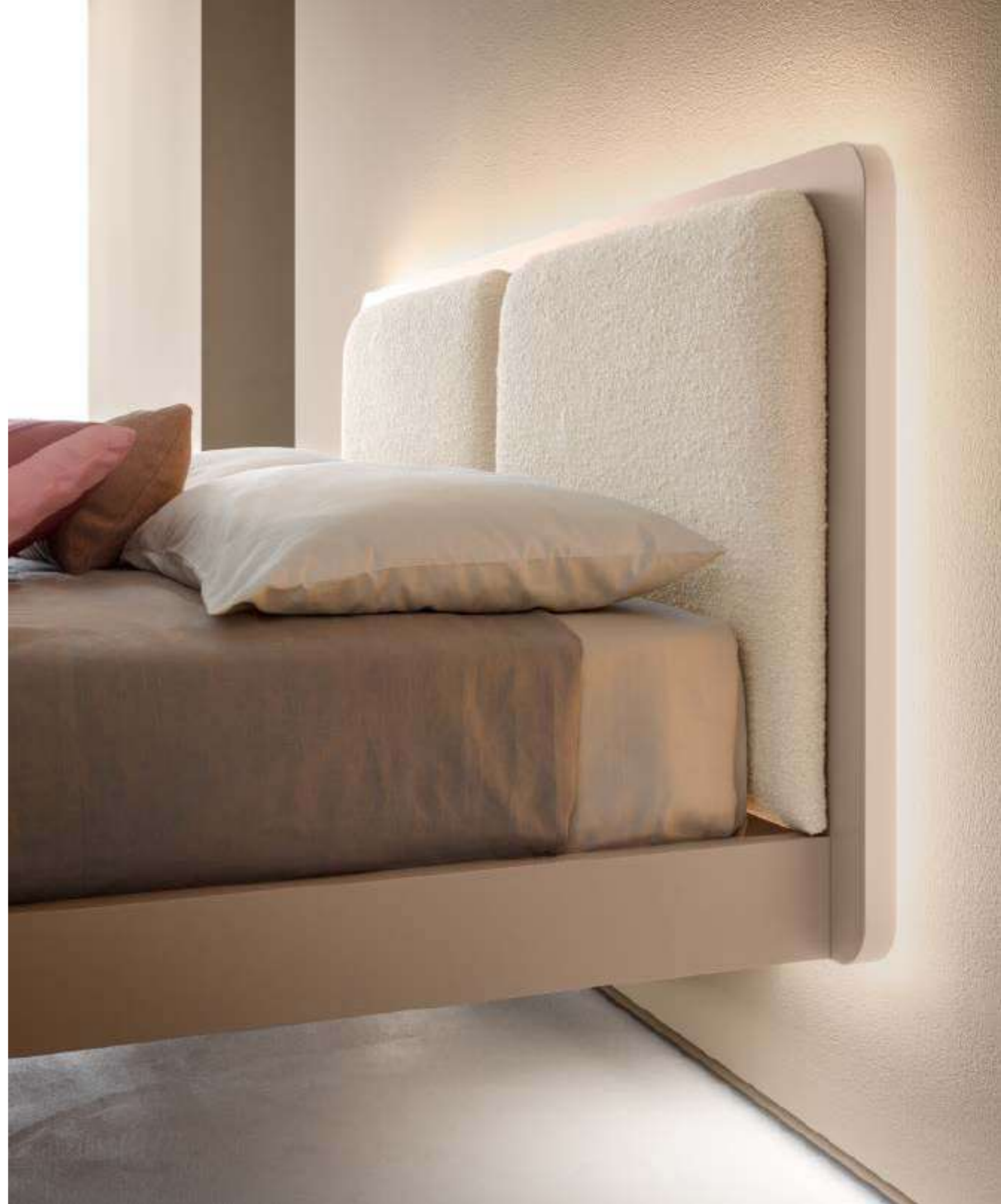



Voile letto / bed  
Laccato opaco Nude e tessuto  
Ricciolone 01 / Matt Nude lacquer  
and Ricciolone 01 Fabric  
L/W 180 P/D216,5 H 102,3

Nadir gruppo notte / storage units  
Laccato opaco Bordeaux / Matt  
Bordeaux lacquer  
L/W160 P/D55,4 H79,6  
→ Cat. Strage units: Nadir p. 014

Tsuki tavolino / occasional tables  
Verniciato Moka shine e vetro bronzo  
satinato/ Moka shine painted and satin  
finish bronze glass L/W60 P/D54,3 H42  
→ Cat. Sofas / Occasional Tables /  
Armchairs



Testiera con cuscini imbottiti /  
Headboard with padded cushions



Testiera legno /  
Wooden headboard



1. Piattaforma P24 / P24 platform
2. Piattaforma P28 Fashion wood / P28 fashion wood platform
3. Piattaforma P28 laccato / P28 lacquered platform

1

2

3

## VOILE

design R&D Alf DaFrè



Voile è un letto caratterizzato da una struttura sospesa, fissata a parete e sostenuta da un piede centrale. La testiera e la pediera possono essere illuminati con LED per creare un'atmosfera raffinata nella zona notte. La testiera è disponibile con o senza cuscini imbottiti sfoderabili e personalizzabile nella gamma di tessuti Alf DaFrè.

**Materiali e finiture**  
Testiera e giroletto in Fashion Wood, laccato opaco, lucido o micallizzato e in nobilitato.  
Struttura nera in metallo.

Voile is a bed featuring a suspended structure fixed to the wall and supported by a central leg. The headboard and the footboard can be illuminated with LEDs to create a refined atmosphere in the bedroom. The headboard is available with or without upholstered removable cushions and can be customized with Alf DaFrè's fabric range.

**Materials and finishes**  
Headboard and bed frame in Fashion Wood, matte lacquer, high gloss lacquer, micaceous lacquer, or surfaced.  
Black metal structure.

### Misure Measurements

P28: L 160 / 180 / 190 / 200  
P 211 / 216,5  
H 102,3 / 112,3  
P24: L 160 / 180 / 190 / 200  
P 209,4 / 214,9  
H 102,3 / 112,3

### Vano rete Inner spring support size

P28: 140,5 X 202 / 207,5  
160,5 X 202 / 207,5  
170,5 X 202 / 207,5  
180,5 X 202 / 207,5  
P24: 140,5 X 200,5 / 206  
160,5 X 200,5 / 206  
170,5 X 200,5 / 206  
180,5 X 200,5 / 206

P28

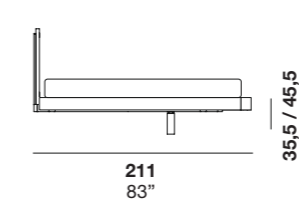
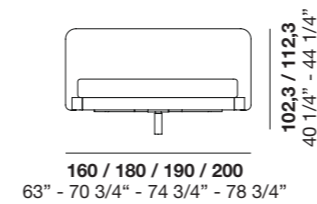

P24

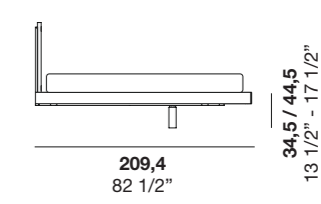
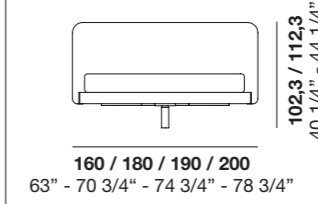

P28, testiera con cuscini / P28, headboard with cushions

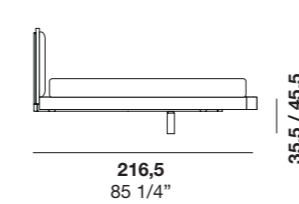
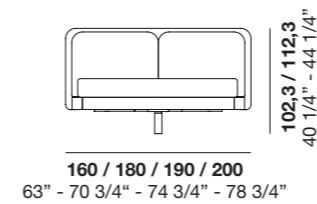

P24, testiera con cuscini / P24, headboard with cushions

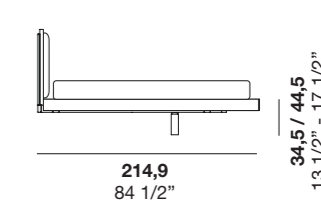
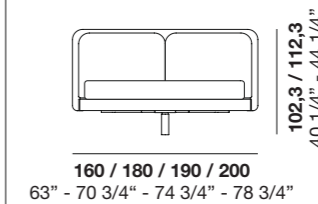

# Levante

Levante si caratterizza per la struttura stondata ed è un letto in legno ideale per completare la zona notte. Offre un rifugio intimo e accogliente, accompagnando il riposo durante tutta la notte.

Levante is characterized by its rounded structure and is an ideal wooden bed to complete the bedroom. It offers an intimate and cozy retreat, accompanying restful sleep throughout the night.

design by R&D Alf DaFrè





Levante letto / bed  
Fashion wood Rovere Ghiro e tessuto  
Regal E014 / Terra oak Fashion wood  
and Regal E014 Fabric  
L/W173,5 P/D214,5 H101

Mei gruppo notte / storage units  
Laccato micalizzato Nickel / Micalized  
Nickel lacquer  
L/W60 P/D46 H46  
→ Cat. Storage units: Mei p. 030



**Levante letto / bed**  
Laccato opaco Mocha Mousse e  
tessuto Made F21 / Matt Mocha  
Mousse lacquer and Made F21 Fabric  
L/W173,5 P/D214,5 H101

**Nadir gruppo notte / storage units**  
Laccato opaco Mocha Mousse /  
Matt Mocha Mousse lacquer  
L/W45 P/D45 H46,8  
L/W160 P/D55,4 H79,6  
→ Cat. Storage units: Nadir p. 014

**Disco specchiera / mirror**  
Moka shine  
Ø96 P/D5,5



Levante letto / bed  
 Fashion wood Rovere Ghiro e tessuto  
 Regal E014 / Terra oak Fashion wood  
 and Regal E014 Fabric  
 L/W173,5 P/D214,5 H101

## LEVANTE

design R&D Alf DaFrè



Levante è un letto caratterizzato dal design morbido e arrotondato della testiera. La testiera è disponibile nella versione con cuscini imbottiti sfoderabili, la struttura e i piedi sono in metallo. Disponibili piedi in legno o metacrilato e nella versione con contenitore.

**Materiali e finiture**  
 Testiera e giroletto in: Fashion Wood, laccato opaco, lucido o micalizzato e in nobilitato.  
 Struttura in metallo e piedi in metallo verniciato moka shine.

**Misure**  
 Measurements  
 P28: L 153,5 / 173,5 / 193,5  
 P 214,5  
 H 101  
 P24: L 153,5 / 173,5 / 193,5  
 P 213  
 H 101

Levante is a bed characterized by the soft, rounded design of the headboard. The headboard is available with removable upholstered cushions, structure and feet in metal. Feet are also available in wood or metacrylate and in the version with storage unit.

**Materials and finishes**  
 Headboard and bed frame in: Fashion Wood, matte, glossy or mica-lacquered finish, and surfaced.  
 Structure in metal and legs in painted moka shine metal.

**Vano rete**  
 Inner spring support size  
 P28: 140,5 X 207,5  
 160,5 X 207,5  
 170,5 X 207,5  
 180,5 X 207,5  
 P24: 140,5 X 206  
 160,5 X 206  
 170,5 X 206  
 180,5 X 206

P28

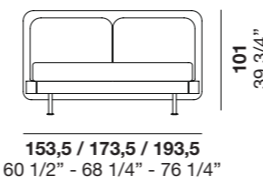

P24

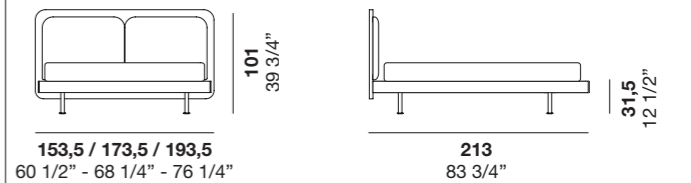

P28 con contenitore / P28 with storage unit

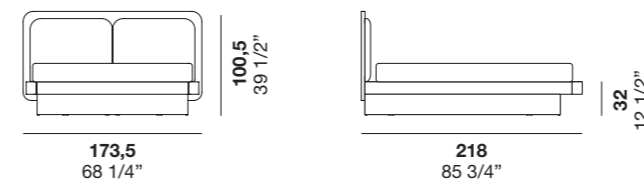

P24 con contenitore / P24 with storage unit

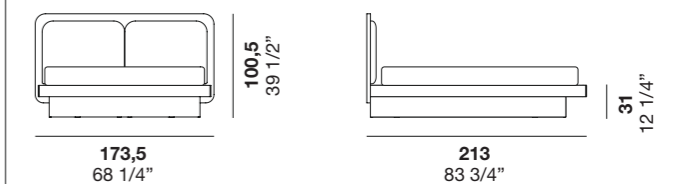

# Righetto

Linee rigorose e materiali autentici definiscono l'identità di Righetto, un letto in legno che coniuga estetica e funzionalità. La testiera, configurabile in doppia finitura, conferisce ritmo estetico grazie alla finitura Groove e carattere attraverso il profilo in alluminio, in una composizione pensata per chi cerca eleganza e soluzioni integrate.

Clean lines and authentic materials define the identity of Righetto, a wooden bed that combines aesthetics with functionality. The headboard, available in a double finish, provides aesthetic rhythm thanks to the Groove finish and character through the aluminium profile, in a design crafted for those seeking elegance and integrated solutions.

design Bruna Vaccher





Raku poltroncina / armchair  
 Tessuto Regal E060 / Regal E060 fabric  
 L/W60 P/D38 H42  
 → Cat. Sofas / Occasional Tables /  
 Armchairs

Righetto letto / bed  
 Groove Noce Naturale e Laccato opaco  
 Moka Shine / Groove Naturale walnut and  
 matt Moka Shine lacquer  
 L/W296 P/D207,4 H100

Ray gruppo notte / bedroom suite  
 Noce Naturale / Natural walnut  
 L/W133 P/D51,5 H74,3  
 → Cat. Storage units: Ray p. 072

Neyō tavolino / occasional table  
 Top Marmo Carrara e struttura verniciato  
 Moka Shine / Carrara marble top and Moka  
 Shine painted structure  
 L/W60 P/D38 H42  
 → Cat. Sofas / Occasional Tables /  
 Armchairs

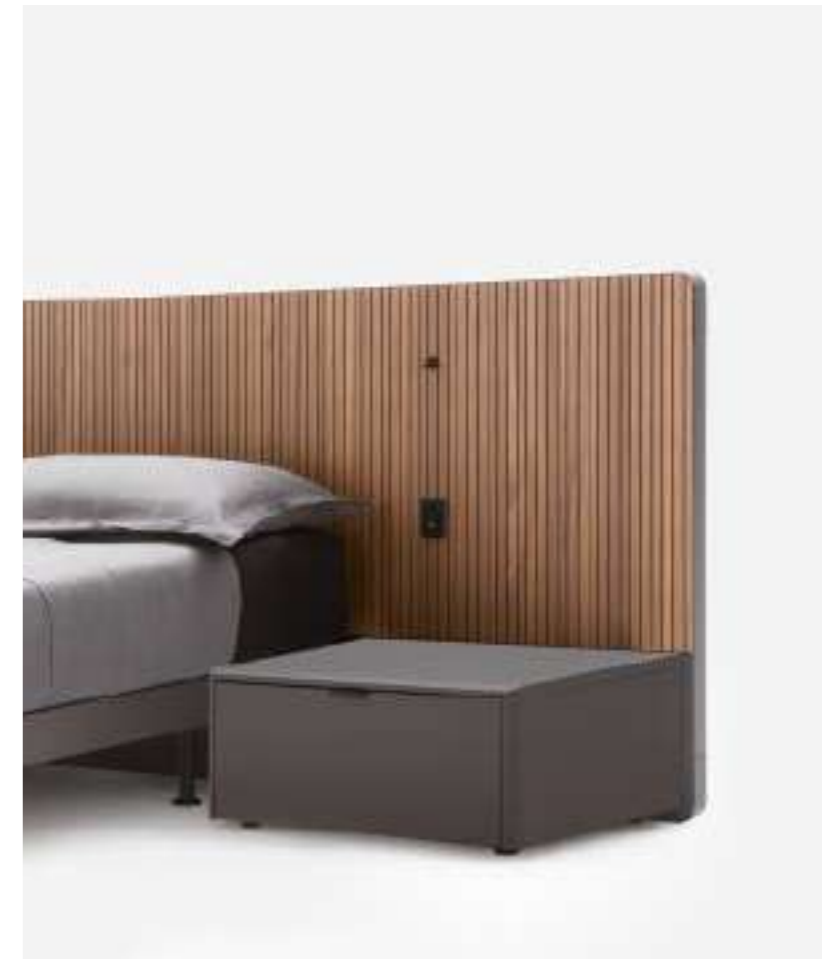



# RIGHETTO

design Bruna Vaccher



Righetto è un letto con testiera legno attrezzabile con faretto e mensola metallo, piattaforma legno con piedini metallo. La testiera con profilo perimetrale in alluminio ha due finiture, una per la parte superiore, l'altra in abbinamento alla piattaforma.

Righetto is a bed with a wooden headboard that can be fitted with a spotlight and metal shelf, and a wooden platform with metal feet. The headboard with an aluminium perimeter profile features two finishes, one for the upper part and one to match the platform.

#### Materiali e finiture

Pannello superiore testiera: Groove Noce, Groove Fashion wood.  
Pannello inferiore testiera e piattaforma: laccato Moka Shine.

#### Materials and finishes

Upper headboard panel: Walnut Groove and Groove Fashion Wood.  
Lower headboard panel and platform: Moka Shine lacquer.

#### Misure

##### Measurements

L296	P207,4	H100
L316	P207,4	H100
L296	P211,8	H100
L332	P224,8	H100
L332	P211,8	H100

#### Vano rete

##### Inner spring support size

160,5 X 200,5
180,5 X 200,5
155 X 205
187 X 218
195 X 205

Legno / Wood

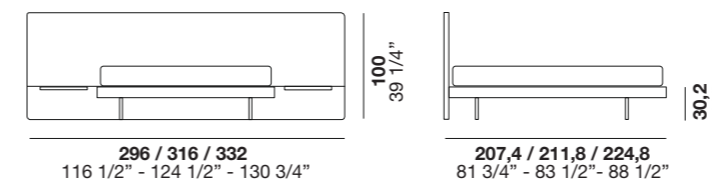

# Milano 2

Un letto imbottito che celebra la morbidezza dei volumi e la cura sartoriale nei dettagli. Milano 2 si distingue per le cuciture a “taglio vivo” e per i cuscini della testiera, sovrapposti con naturalezza in un gesto che richiama immediatamente comfort e accoglienza. Una vera e propria coccola per chi cerca un rifugio elegante e raffinato. Disponibile anche nella versione con contenitore, per unire estetica e funzionalità.

An upholstered bed that celebrates the softness of its volumes and the sartorial attention to detail. Milano 2 stands out with its “raw edge” stitching and the cushions on the headboard, naturally layered in a gesture that immediately evokes comfort and warmth. A true embrace for those seeking an elegant and refined retreat. Also available with storage, combining aesthetics and functionality.

design Enrico Cesana





Milano 2 letto / bed  
Tessuto Nina 39 / Nina 39 fabric  
L/W184 P/D234,8 H94,3

Defilè gruppo notte / bedroom suite  
Groove Noce naturale e laccato opaco  
Moka shine / Groove Naturale walnut and

matt Moka Shine lacquer  
L/W377 P/D52,4 H73,4  
→ Cat. Storage units: Defilè p. 046



Disco specchiera / mirror  
 Verniciato Moka shine / Moka Shine painted  
 Ø76,5 P/D5,5

Milano 2 letto / bed  
 Pelle Lord 9130 / Lord 9130 leather  
 L/W184 P/D234,8 H94,3

Twice gruppo notte / storage units  
 Laccato opaco Modica / Matt Modica  
 lacquer

L/W64 P/D47,4 H44,4  
 L/W150 P/D54 H74,2  
 → Cat. Storage units: Twice p. 206



Milano 2 letto / bed  
Tessuto antibes 100 / Antibes 100 fabric  
L/W184 P/D234,8 H94,3

Twice gruppo notte / storage units  
Laccato opaco Nero e gola Laccato opaco  
Cuoio / Matt Nero lacquer and matt Cuoio  
lacquer groove  
L/W64 P/D47,4 H44,4  
→ Cat. Storage units: Twice p. 206



## MILANO 2

design Enrico Cesana



Dotato, nella versione pelle, di particolari cuciture "taglio al vivo" che ne delineano i contorni, Milano 2 è un letto imbottito elegante e originale. I morbidi cuscini della testiera si "appoggiano" creando un piacevole gioco di livelli. Due le misure, anche con contenitore.

Featuring unusual, raw-cut stitching in the leather version which decorates the edging, the Milano 2 padded bed is both elegant and original. The soft cushions appear to rest on the headboard, creating the effect of different levels. It is available in two sizes, including with storage possibilities.

**Materiali e finiture**  
Rivestimento: Tessuti, Pelle, Ecopelle.

**Materials and finishes**  
Upholstery: Fabric, leather, ecoleather.

**Misure**  
Measurements

L184 P234,8 H94,3  
L204 P234,8 H94,3

Disponibile anche con contenitore

**Vano rete**  
Inner spring support size

160,5 X 202  
180,5 X 202

Also available with storage unit



Imbottiti / Upholstered

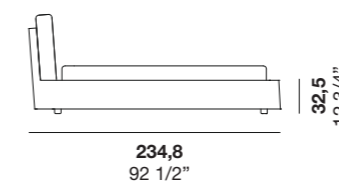
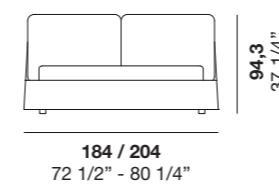

# Yume

Disegnato da Gordon Guillaumier, Yume è la sintesi tra forma fluida e sostenibilità. Ogni elemento, dalla testiera al giroletto, è progettato per essere disassemblato, in un equilibrio tra estetica avvolgente e consapevolezza ambientale. Un'eleganza responsabile che trasforma la zona notte in un nido intimo, un'isola di riposo.

Designed by Gordon Guillaumier, Yume is the perfect blend of fluid form and sustainability. Every element—from the headboard to the bed frame—is designed to be fully disassembled, striking a balance between enveloping aesthetics and environmental awareness. A responsible elegance that turns the bedroom into an intimate nest, an island of rest.

design Gordon Guillaumier





**Raku** poltroncina / armchair  
 Tessuto Iris 302 / Iris 302 fabric  
 L/W84 P/D69 H75  
 → Cat. Sofas / Occasional Tables /  
 Armchairs

**Yume** letto / bed  
 Tessuto Iris 302 / Iris 302 fabric  
 L/W192 P/D230 H102

**Rim** gruppo notte / storage units  
 Laccato micallizzato Palladio / Palladio  
 micallised lacquer  
 L/W40 P/D40 H52  
 → Cat. Storage units: Rim p. 188

**Neyo** tavolino / occasional table  
 Top Marmo Carrara e struttura verniciato  
 Moka Shine / Carrara marble top and Moka  
 Shine painted structure L/W60 P/D38 H42  
 → Cat. Sofas / Occasional Tables /  
 Armchairs



088

Alf DaFrè



Yume

Letti / Beds

089



**Yume letto / bed**  
Tessuto Antibes 901 / Antibes 901 fabric  
L/W192 P/D230 H102

**Neyō tavolino / occasional table**  
Top Marmo Carrara e struttura verniciato  
Moka Shine / Carrara marble top and Moka  
Shine painted structure  
L/W60 P/D38 H42  
→ Cat. Sofas / Occasional Tables / Armchairs



# YUME

design Gordon Guillaumier



Il letto Yume è costituito da due elementi principali, la testiera ed il giroletto. Entrambi sono pensati nell'ottica della sostenibilità sia per quanto riguarda materiali che per la progettazione. Gli elementi che compongono testiera e giroletto, ovvero fusto, imbottitura poliuretana, pre-fodera e rivestimento in tessuto, sono tutti disassemblabili tra loro.

The Yume bed has two main elements: the headboard and the bed frame. Both have been designed with a focus on sustainability, for the design itself and the choice of materials. The elements that make up the headboard and bed frame – the carcass, polyurethane padding, pre-lining and fabric upholstery – are all detachable from one another.

**Materiali e finiture**  
Rivestimento: Tessuti, Pelle, Ecopelle.

**Materials and finishes**  
Upholstery: Fabric, leather, ecoleather.

**Misure**  
Measurements

L192	P230	H102
L212	P230	H102

Disponibile anche con contenitore

**Vano rete**  
Inner spring support size

160,5 X 202
180,5 X 202

Also available with storage unit

Imbottiti / Upholstered

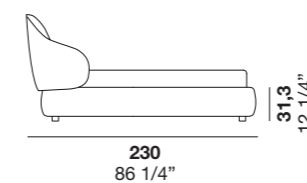
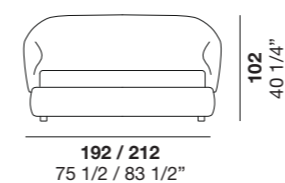

**IT** Questa è la storia di Yume, un letto progettato nel rispetto dell'ambiente. Il design morbido e avvolgente di Gordon Guillaumier è stato sviluppato ed esaltato attraverso la ricerca sui materiali selezionati su base green e dal metodo di produzione, che ne permettono la totale e agile differenziazione in fase di smaltimento. Queste sono le caratteristiche imprescindibili per un prodotto del futuro.

**EN** This is the story of Yume: a bed designed with the environment in mind. Gordon Guillaumier's soft, enveloping design has been enhanced by research into the materials used – chosen for their greenness – and the smart production method, whereby the parts are separable for recycling and disposal. This is what it means to be a product of the future.

**IT** Il fusto in legno per la testiera, viene realizzato utilizzando una combinazione di multistrato e multiflex per poter seguire al meglio la curvatura voluta dal designer. Entrambi sono certificati FSC e riciclabili.  
**EN** The wooden frame for the headboard is made with a combination of plywood and Multiflex to create the curved finish chosen by the designer. Both are recyclable and FSC-certified.



**IT** Questa costruzione dà la possibilità di riciclare correttamente i materiali, dal legno alle parti metalliche già in parte provenienti da riciclo.  
**EN** This makes the materials easy to recycle, including the wood and the metal components (already partially from recycled sources).



- ① Struttura realizzata utilizzando una combinazione di multistrato e multiflex.  
/ Frame made from a combination of plywood and Multiflex.
- ② Imbottitura poliuretana a differenti densità per un maggiore comfort.  
/ Polyurethane padding in different densities for better comfort.
- ③ Pre-fodera pensata per poter essere successivamente sfilata dal poliuretano tramite una cerniera.  
/ Pre-lining detachable from padding with zip.
- ④ Vestito in tessuto è sfoderabile agevolmente tramite l'uso del velcro.  
/ Fabric upholstery with Velcro fastening for easy removal.



**IT** L'imbottitura poliuretana, che prevede due diverse densità per un maggior comfort, viene accoppiata e non più incollata direttamente al fusto in legno.  
**EN** The polyurethane padding is bonded, rather than glued, to the wooden frame, and has two different densities for added comfort.

# Neyō

Neyō nasce dall'ispirazione organica dei ciottoli di fiume, trasformata in un letto dal design curvo e armonico.

Le superfici imbottite dialogano con ripiani e cassetti integrati, disegnando una soluzione che fonde comfort e funzionalità in un gesto unico e sofisticato.

Neyō draws inspiration from the organic shapes of river stones, transformed into a bed with a curved and harmonious design. The upholstered surfaces interact with integrated shelves and drawers, creating a solution that blends comfort and functionality in a single, sophisticated gesture.

design Gordon Guillaumier





**Neyō letto / bed**  
Tessuto Antibes 806, Fashion wood Rovere  
Naturale e Marmo Carrara / Antibes 806  
fabric, Naturale oak Fashion Wood and  
Carrara marble  
L/W315,5 P/D220,3 H98,5





Neyō letto / bed  
Tessuto Iris 403, Fashion wood Rovere  
Fossile e Marmo Carrara / Iris 403 fabric,  
Fossile oak Fashion Wood and Carrara marble  
L/W315,5 P/D220,3 H98,5



**Neyō letto / bed**  
Tessuto Iris 403, Fashion wood Rovere  
Fossile e Marmo Carrara / Iris 403 fabric,  
Fossile oak Fashion Wood and Carrara marble  
L/W315,5 P/D220,3 H98,5





# NEYŌ

design Gordon Guillaumier

Registered design



La linea del letto Neyō si ispira alla forma organica dei ciottoli di fiume levigati dall'acqua. Il disegno morbido che definisce sia gli elementi imbottiti sia i doppi ripiani regala alla composizione l'aria avvolgente e funzionale di un letto a cui non servono altri complementi.

The line of the Neyō bed is inspired by the organic shape of pebbles washed smooth by the flow of a river. The soft design of both the padded elements and the double shelf adds a welcoming, functional feel to the composition. This bed needs no further accessories.

#### Materiali e finiture

Testiera e piattaforma: Tessuti, Pelle, Ecopelle.  
Comodini: Fashion wood, Rovere laccati opachi, Marmo di Carrara.  
Piedi: metallo verniciato Moka Shine.

#### Materials and finishes

Headboard and platform: Fabric, Leather, Ecological leather.  
Bedside tables: Fashion Wood, Matt lacquered oak, Carrara marble.  
Feet: Moka Shine painted metal.

#### Misure

Measurements

L237,7 P220,3 H98,5  
L257,7 P220,3 H98,5

#### Vano rete

Inner spring support size

160,5 X 200,5  
180,5 X 200,5

Imbottiti / Upholstered

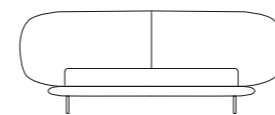

237,7 / 257,7  
93 1/2" - 101 1/2"

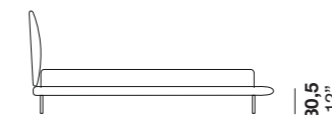

220,3  
86 3/4"

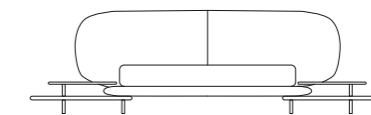

315,5 / 335,5  
124 1/4" - 132"

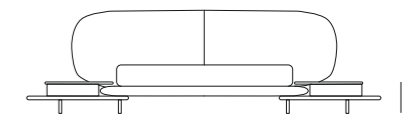

315,5 / 335,5  
124 1/4" - 132"

# Jetty 2

Struttura metallica, essenzialità estetica e finiture materiche: Jetty 2 è un letto moderno, disegnato da Gordon Guillaumier, che gioca tra rigore e comfort. La testiera in tessuto o cuoio si staglia con forza, mentre la nuova versione con longoni rivestiti ne arricchisce il linguaggio, in equilibrio tra tecnica e stile. Linee dritte e schematiche svelano l'inaspettata leggerezza di un letto disegnato in wireframe e riempito nel volume dallo stesso materasso.

Metal structure, essential aesthetics, and textured finishes: Jetty 2 is a modern bed, designed by Gordon Guillaumier, that plays between rigor and comfort. The fabric or leather headboard stands out boldly, while the new version with upholstered side rails enriches its language, balancing technique and style. Straight, clean lines reveal the unexpected lightness of a bed designed in wireframe and filled in volume by the mattress itself.

design Gordon Guillaumier





Jetty 2 letto / bed  
Cuoio 1004 e Elettrocol raggrinzante / 1001  
Leather and textured Elettrocol  
L/W174 P/D212,2 H94,5



Jetty 2 letto / bed  
Tessuto Taiga 01 colore 90/1 e Elettrocol  
raggrinzante / Taiga 01 fabric colour 90/1  
and textured Elettrocol  
L/W174 P/D212,2 H94,5

Disco specchiera / mirror  
Verniciato Moka shine / Moka Shine painted  
Ø76,5 P/D5,5  
Ø50 P/D5,5

Raku panca / bench  
Tessuto Please 802 / Please 802 fabric  
L/W150 P/D58 H53  
→ Cat. Sofas / Occasional Tables /  
Armchairs



**Jetty 2** letto con rivestimento Dressed /  
bed with Dressed upholstery  
Tessuto Antibes 904 e Elettrocol  
raggrinzante / Antibes 904 fabric and  
textured Elettrocol  
L/W174 P/D212,2 H94,5

**Nobu** gruppo notte / storage unit  
Tessuto Antibes 904 e vassoio Laccato  
micalizzato Nickel / Antibes 904 fabric and  
micalised Nickel lacquer tray  
L/W38,6 P/D42,6 H38  
→ Cat. Storage units: Nobu p. 114

**Disco** specchio / mirror  
Verniciato Moka shine / Moka Shine  
painted  
Ø76,5 P/D5,5

## JETTY 2

design Gordon Guillaumier



Il letto Jetty 2 è caratterizzato dalla struttura in metallo tubolare finitura elettrocol, con testiera in cuoio o tessuto, oggi viene integrato dalla versione con longoni rivestiti.

**Materiali e finiture**  
Struttura metallo: finitura "elettrocol".  
Testiera: Tessuti, Pelle, Ecopelle.

**Misure**  
Measurements

L174	P212,2	H94,5
L194	P212,2	H94,5

The Jetty 2 bed, with a tubular metal frame in an Elettrocol finish and a leather or fabric headboard, is now complemented by a version with upholstered frame members.

**Materials and finishes**  
Metal frame: "Elettrocol" finish.  
Headboard: Fabric, leather, ecoleather.

**Vano rete**  
Inner spring support size

160,5 X 200,5
180,5 X 200,5



Imbottito / Upholstered

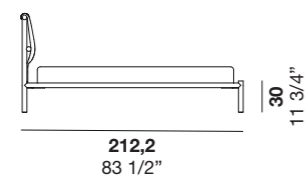
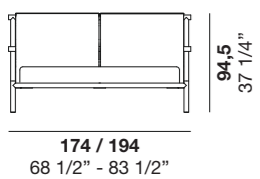

## JETTY 2

con rivestimento Dressed

design Gordon Guillaumier



**Materiali e finiture**  
Struttura metallo: finitura "elettrocol".  
Testiera: Tessuti, Pelle, Ecopelle, Cuoio.  
Rivestimento piattaforma: Tessuti, Ecopelle.

**Misure**  
Measurements

L174	P212,2	H94,5
L194	P212,2	H94,5

**Materials and finishes**  
Metal frame: "Elettrocol" finish.  
Headboard: Fabric, leather (two types), ecoleather.  
Platform upholstery: Fabric, ecoleather.

**Vano rete**  
Inner spring support size

160,5 X 200,5
180,5 X 200,5



Con rivestimento / Dressed

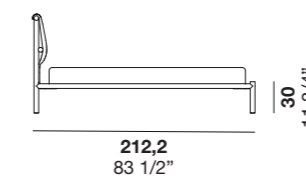
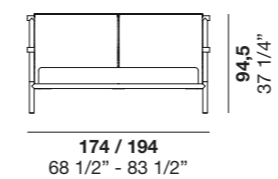

# Atlas

Linee essenziali e dettagli sofisticati definiscono l'estetica di Atlas, letto imbottito con struttura in legno e metallo, disegnato da Enrico Cesana. I piedini sottili e ben bilanciati conferiscono leggerezza visiva, evocando un senso di sospensione, mentre la testiera presenta due cuscini imbottiti che aggiungono comfort e stile. Un progetto che unisce comfort visivo, proporzioni eleganti e un'equilibrata matericità.

Essential lines and sophisticated details define the aesthetics of Atlas, an upholstered bed with a wood and metal frame, designed by Enrico Cesana. The slim, well-balanced legs provide visual lightness, evoking a sense of suspension, while the headboard features two padded cushions that add comfort and style. A design that combines visual comfort, elegant proportions, and balanced materiality.

design Enrico Cesana





**Rim gruppo notte / storage units**  
Laccato micallizzato Palladio / Palladio  
micalised lacquer  
L/W40 P/D40 H52  
→ Cat. Storage units: Rim p. 188

**Denny pouf**  
Tessuto Regal E037 / Regal E037 fabric  
Ø55 H42  
→ Cat. Sofas / Occasional Tables /  
Armchairs

**Atlas letto / bed**  
Tessuto Rubens 03 e Fashion wood Rovere  
Carbone / Rubens 03 fabric and Carbone  
oak Fashion Wood  
L/W185,9 P/D224,5 H97,5

**Fil gruppo notte / storage units**  
Laccato opaco Platino / Matt Platino  
lacquer  
L/W180 P/D48 H45,6  
→ Cat. Storage units: Fil p. 148

**Fil specchiera / mirror**  
Verniciato Moka Shine / Moka Shine  
painted  
L/W60 P/D5 H90  
→ Cat. Storage units: Fil p. 148



**Atlas letto / bed**  
Tessuto Regal E042 e Fashion wood Rovere Naturale / Regal E042 fabric and Naturale oak Fashion Wood  
L/W185,9 P/D224,5 H97,5

**Ray gruppo notte / storage units**  
Laccato opaco Platino e Fashion wood Rovere Carbone / Matt Platino lacquer and Carbone oak Fashion Wood  
L/W60 P/D46,5 H46,2  
→ Cat. Storage units: Ray p. 072



## ATLAS

design Enrico Cesana



Atlas è un letto imbottito con struttura in legno e metallo. La particolare conformazione dei piedini e il loro aggancio inclinato alla piattaforma crea un piacevole effetto di "sospensione", rafforzato dal sottile giroletto.

Atlas is an upholstered bed with a wooden and metal frame. The unusual shape of the feet and angled attachment to the bed platform create an intriguing "floating" effect, confirmed by the slim frame.

### Materiali e finiture

Struttura: verniciato Moka shine, Nickel.  
Rivestimento: Tessuti, Pelle, Ecopelle.  
Piedi: Fashion wood, Noce.

### Materials and finishes

Frame: painted in Moka Shine, Nickel.  
Upholstery: Fabric, leather, ecoleather.  
Feet: Fashion Wood, walnut.

### Misure

#### Measurements

L185,9 P224,5 H97,5  
L205,9 P224,5 H97,5

### Vano rete

#### Inner spring support size

160,5 X 200,5  
180,5 X 200,5



**Atlas letto / bed**  
Tessuto Rubens 03 e Fashion wood Rovere  
Carbone / Rubens 03 fabric and Carbone  
oak Fashion Wood  
L/W185,9 P/D224,5 H97,5



**Atlas letto / bed**  
Tessuto Regal E042 e Fashion wood Rovere  
Naturale / Regal E042 fabric and Naturale  
oak Fashion Wood  
L/W185,9 P/D224,5 H97,5

### Imbottito / Upholstered

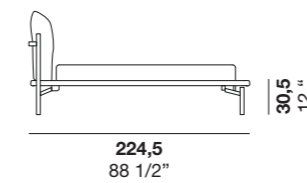
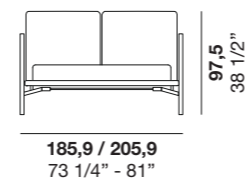

# Hug

Hug è un letto pensato per accogliere. La testiera curva si prolunga ai lati creando un abbraccio visivo e tattile, mentre il rivestimento in tessuto e cuoio amplifica la sensazione di intimità. Ogni elemento suggerisce calore e protezione, con una ricercatezza formale che non rinuncia alla morbidezza.

Hug is a bed designed to embrace. The curved headboard extends to the sides, creating a visual and tactile embrace, while the upholstery in fabric and leather enhances the feeling of intimacy. Every element conveys warmth and protection, with a refined design that never sacrifices softness.

design Enrico Cesana





**Disco specchiera / mirror**  
 Verniciato Moka shine / Moka Shine painted  
 Ø76,5 P/D5,5

**Hug letto / bed**  
 Cuoio 1031 e Tessuto Antibes 802 / 1031  
 Leather and Antibes 802 fabric  
 L/W177 P/D226 H94

**Ray gruppo notte / storage units**  
 Laccato opaco Juta e Top Laminam Sahara  
 Noir extra lucidato / Matt Juta lacquer and  
 Extra-glossy Sahara Noir top

L/W60 P/D46,5 H46,2  
 L/W133 P/D51,5 H74,3  
 L/W60 P/D51,5 H119  
 → Cat. Storage units: Ray p. 072



**Hug letto / bed**  
Cuoio Naturale e Tessuto Taiga 01 colore  
02/1 / Naturale leather and Taiga 01 fabric  
colour 02/1  
L/W177 P/D226 H94

**Moka tavolino / occasional table**  
Laccato opaco Nero / Matt Nero lacquer  
Ø60 H45,4  
→ Cat. Sofas / Occasional Tables /  
Armchairs

**Disco specchiera / mirror**  
Verniciato Moka shine / Moka Shine painted  
Ø96 P/D5,5

# HUG

design Enrico Cesana



Hug è un letto con testiera e piattaforma imbottiti. Si caratterizza per il retro testiera sagomato che si estende ai lati "abbracciando" testiera e piattaforma.

**Materiali e finiture**  
Rivestimento: Tessuti, Pelle, Ecopelle.  
Retro testiera in cuoio.

**Misure**  
Measurements

L177    P226    H94  
L197    P226    H94

Disponibile anche con contenitore

Hug is a bed with upholstered headboard and platform. The main feature is its shaped headboard back, which wraps around the headboard and platform.

**Materials and finishes**  
Upholstery: Fabric, leather, ecoleather.  
Leather headboard back.

**Vano rete**  
Inner spring support size

160,5 X 202  
180,5 X 202

Also available with storage unit



Imbottiti / Upholstered

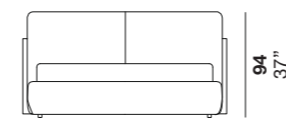

177 / 197  
69 3/4" / 77 1/2"

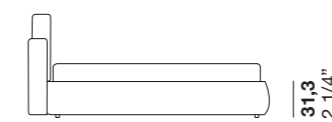

226  
89"

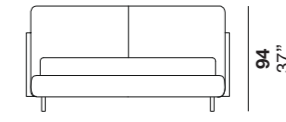

177 / 197  
69 3/4" / 77 1/2"

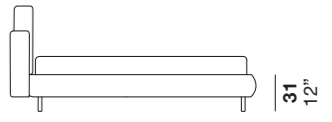

226  
89"

# Morrison 2

Volumi pieni e superfici morbide rendono Morrison 2 un letto dall'eleganza concreta. La testiera accoglie con le sue ali laterali inclinate, mentre la base, a scelta tra sommier o piedini, interpreta con flessibilità il riposo quotidiano. Ampia la modularità, anche in versione contenitore.

Full volumes and soft surfaces give Morrison 2 a sense of tangible elegance. The headboard, with its inclined side wings, offers a welcoming embrace, while the base—available with either a sommier or legs—flexibly adapts to everyday rest. Generous modularity is also available in a storage bed version.

design R&D Alf DaFrè / Enrico Cesana





**Disco specchiera / mirror**  
 Verniciato Moka shine / Moka Shine painted  
 Ø76,5 P/D5,5

**Morrison 2 letto / bed**  
 Tessuto Rubens 02 / Rubens 02 fabric  
 L/W197 P/D230 H104

**Haiku servomuto / clothes stand**  
 Struttura verniciato Moka shine e Ripiani  
 Fashion wood Rovere Fossile / Moka Shine  
 painted structure and Fossile oak Fashion  
 Wood shelves L/W50 P/D32 H120,3

**Gorge gruppo notte / storage units**  
 Noce Naturale e top Laminam Sahara Noir  
 extra lucidato / Naturale walnut and Extra-  
 glossy Laminam Sahara Noir top  
 L/W60 P/D45 H47,2 L/W150 P/D50 H74,4  
 → Cat. Storage units: Gorge p. 054



**Morrison 2 letto / bed**  
Tessuto Taiga 01 colore 90/2 / Taiga 01  
colour 90/2 fabric  
L/W197 P/D230 H104

**Adj gruppo notte / storage units+**  
Fashion wood Rovere Carbone / Carbone  
oak Fashion Wood  
L/W60 P/D46 H46  
→ Cat. Storage units: Adj p. 120



Morrison 2 letto / bed  
Tessuto Nina 37 / Nina 37 fabric  
L/W197 P/D229 H104

Gorge gruppo notte / storage units  
Fashion wood Rovere terra e top Laminam  
Sahara Noir extra lucidato / Terra oak Fashion  
Wood and Extra-glossy Sahara Noir top  
L/W60 P/D45 H55,5  
L/W120 P/D50 H82,7  
→ Cat. Storage units: Gorge p. 054



# MORRISON 2

design R&D Alf DaFrè / Enrico Cesana



In questo letto le sezioni laterali leggermente inclinate della testiera portano lo sguardo al morbido rivestimento della parte centrale. Morrison 2 dà libera scelta all'abbinamento tra il sommier o la piattaforma con piedini in metallo. Ampia la scelta di misure, anche con contenitore.

The angled sides of the headboard emphasise the soft upholstered centre. Morrison 2 can be combined as a divan bed or with a platform and metal feet. There are a wide range of sizes available, including with storage space.

Materiali e finiture  
Rivestimento: Tessuti, Pelle, Ecopelle.

Materials and finishes  
Upholstery: Fabric, leather, ecoleather.

## Misure Measurements

L197	P230	H104
L217	P230	H104
L191,5	P235	H104
L223,5	P247	H104
L231,5	P235	H104

## Vano rete Inner spring support size

160,5 X 202
180,5 X 202
155 X 207
187 X 219
195 X 207



Materiali e finiture  
Rivestimento: Tessuti, Pelle, Ecopelle.

Materials and finishes  
Upholstery: Fabric, leather, ecoleather.

## Misure Measurements

L197	P229	H104
L217	P229	H104
L191,5	P234	H104
L223,5	P246	H104
L231,5	P234	H104

Disponibile anche con contenitore

## Vano rete Inner spring support size

160,5 X 202
180,5 X 202
155 X 207
187 X 219
195 X 207

Also available with storage unit



## Imbottito / Upholstered

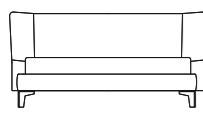

104  
41"

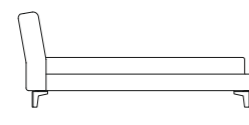

33  
13"

191,5 / 197  
217 / 223,5 / 231,5  
75 1/2" - 77 1/2"  
85 1/2" - 88" - 91 1/4"

230 / 235 / 247  
90 1/2" - 92 1/2" - 97 1/4"

## Imbottito / Upholstered

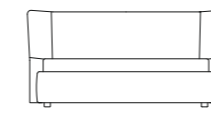

104  
41"

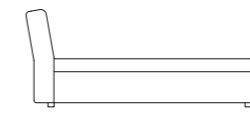

31,3  
12 1/4"

191,5 / 197  
217 / 223,5 / 231,5  
75 1/2" - 77 1/2"  
85 1/2" - 88" - 91 1/4"

229 / 234 / 246  
90 1/4" - 92 1/4" - 96 3/4"

## Imbottito Con piede X07 / With X07 feet

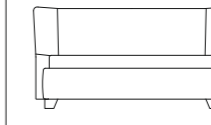

108  
43"

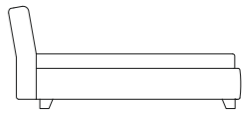

36,4  
14 1/4"

191,5 / 197  
217 / 223,5 / 231,5  
75 1/2" - 77 1/2"  
85 1/2" - 88" - 91 1/4"

229 / 234 / 246  
90 1/4" - 92 1/4" - 96 3/4"

# Orion

Un segno grafico, deciso e orizzontale, attraversa la testiera di Orion, letto imbottito disponibile con base sommier o piedini. La cucitura diventa un dettaglio distintivo che enfatizza la morbidezza della testiera, dove l'essenzialità del disegno incontra la qualità dei rivestimenti per un'estetica misurata, perfetta per ambienti contemporanei dallo spirito rilassato.

A bold, horizontal graphic line runs across the headboard of Orion, an upholstered bed available with either a divan base or feet. The stitching becomes a distinctive detail that enhances the softness of the headboard, where the clean design meets the quality of the upholstery for a measured aesthetic — perfect for contemporary spaces with a relaxed spirit.

design R&D Alf DaFrè





**Denny pouf**  
 Tessuto Antibes 901 / Antibes 901 fabric  
 Ø55 H42  
 → Cat. Sofas / Occasional Tables / Armchairs

**Disco specchiera / mirror**  
 Verniciato Moka shine / Moka Shine painted  
 Ø76,5 P/D5,5  
 Ø50 P/D5,5

**Orion letto / bed**  
 Tessuto Antibes 805 / Antibes 805 fabric  
 L/W177 P/D219 H115

**Hobby gruppo notte / storage units**  
 Fashion wood Rovere Fossile e basamento  
 verniciato Moka shine / Fossile oak Fashion  
 Wood and Moka Shine painted base

L/W55,7 P/D44 H42  
 L/W134,2 P/D52,7 H75,4  
 → Cat. Storage units: Hobby p. 168



**Orion** letto / bed  
Tessuto Nina 55 / Nina 55 fabric  
L/W177 P/D219 H102





Orion letto / bed  
Tessuto Nina 55 / Nina 55 fabric  
L/W177 P/D219 H102

Timeless gruppo notte / storage units  
Laccato opaco Arena / Matt Arena lacquer  
L/W60 P/D45 H30,9  
→ Cat. Storage units: Timeless p. 194

# ORION

design R&D Alf DaFrè



Orion è un letto imbottito con testiera e piattaforma sommier o con piedini. Una marcata cucitura orizzontale nella testiera ne definisce lo stile.

Orion is an upholstered bed with a headboard and divan platform or feet. Statement stitching across the headboard defines the style.

**Materiali e finiture**  
Rivestimento: Tessuti, Pelle, Ecopelle.

**Materials and finishes**  
Upholstery: Fabric, leather, ecoleather.

**Misure**  
Measurements

**Vano rete**  
Inner spring support size

L177 P219 H102  
L197 P219 H102

160,5 X 202  
180,5 X 202



Imbottito / Upholstered

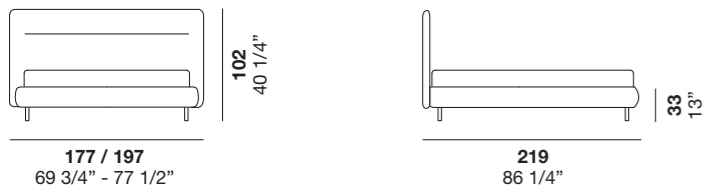

**Materiali e finiture**  
Rivestimento: Tessuti, Pelle, Ecopelle.

**Materials and finishes**  
Upholstery: Fabric, leather, ecoleather.

**Misure**  
Measurements

**Vano rete**  
Inner spring support size

L177 P219 H115  
L197 P219 H115

160,5 X 202  
180,5 X 202

Disponibile anche con contenitore

Also available with storage unit



Imbottito / Upholstered

Imbottito Con piede X07 / With X07 feet

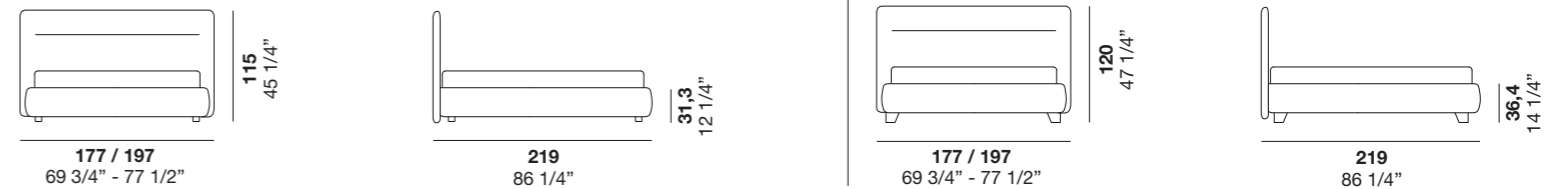

# Cassiopea

Cassiopea è un letto imbottito dal carattere raffinato ed elegante. La testiera si distingue per la possibilità di abbinare due finiture: una per il pannello frontale, diviso da una cucitura centrale, e una per il bordo esterno, in continuità con la base. Un progetto elegante che valorizza la combinazione materica e il dettaglio sartoriale.

Cassiopea is an upholstered bed with a refined and elegant character. The headboard stands out for the combination of two finishes: one for the central front panel, divided by a central seam, and one for the outer edge that continues along the base. An elegant design that enhances material contrasts and tailored details.

design R&D Alf DaFrè





**Cassiopea letto / bed**  
Tessuto Fado 1 / Fado 1 fabric  
L/W176 P/D223 H104

**Fil gruppo notte / storage units**  
Laccato opaco Fango / Matt Fango lacquer  
L/W60 P/D48 H46,9  
→ Cat. Storage units: Fil p. 148

**Suite System 2 boiserie / wall panels**  
Nobilitato Noce naturale / Surfaced  
Naturale walnut  
**Mensole metallo / Metal shelves**  
Verniciato Moka shine / Moka Shine  
painted



**Cassiopea letto / bed**  
Tessuto Fado 1 / Fado 1 fabric  
L/W176 P/D223 H104

**Denny pouf**  
Tessuto Fado 1 / Fado 1 fabric  
Ø55 H52  
→ Cat. Sofas / Occasional Tables /  
Armchairs



**Cassiopea letto / bed**  
Pelle Lord 9120 e Tessuto Taiga 01 colore  
30/1 / Lord 9120 leather and Taiga 01 fabric  
colour 30/1  
L/W176 P/D223 H118

**Rim gruppo notte / storage units**  
Laccato micalizzato / Palladio micalised  
lacquer Ø40 H52  
→ Cat. Storage units: Rim p. 188

# CASSIOPEA

design R&D Alf DaFrè



Cassiopea è un letto imbottito con testiera e piattaforma sommier o con piedini. Si distingue per la possibilità di abbinare due finiture, una per la piattaforma e bordo esterno testiera, l'altra per il pannello frontale diviso da una cucitura.

Cassiopea is an upholstered bed with a headboard and divan platform or feet. Two finishes can be used together with this bed, one on the platform and outer edge of the headboard, the other on the front headboard panel, with stitching down the middle.

Materiali e finiture  
Rivestimento: Tessuti, Pelle, Ecopelle.

Materials and finishes  
Upholstery: Fabric, leather, ecoleather.

Misure  
Measurements

Vano rete  
Inner spring support size

L176 P223 H104  
L196 P223 H104

160,5 X 202  
180,5 X 202



Materiali e finiture  
Rivestimento: Tessuti, Pelle, Ecopelle.

Materials and finishes  
Upholstery: Fabric, leather, ecoleather.

Misure  
Measurements

Vano rete  
Inner spring support size

L176 P223 H104  
L196 P223 H104

160,5 X 202  
180,5 X 202

Disponibile anche con contenitore

Also available with storage unit



Imbottito / Upholstered

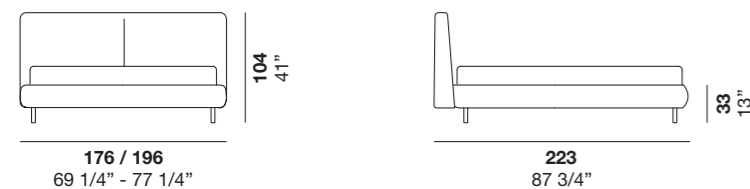

Imbottito / Upholstered

Imbottito con piede X07 / With X07 feet

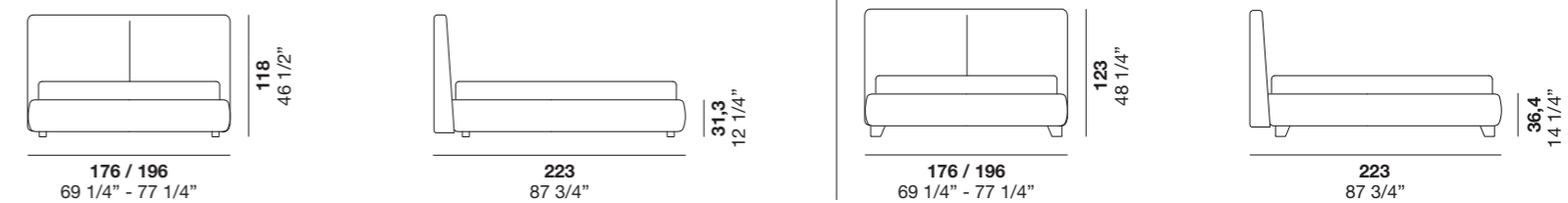

# Miram

Miram è un letto imbottito dalle proporzioni generose e dall'eleganza senza tempo. La testiera, alta e accogliente, è valorizzata da una raffinata lavorazione trapuntata che ne esalta il volume e la morbidezza. Disponibile in più altezze e rivestimenti, si adatta con stile ad ambienti sofisticati e rilassanti.

Miram is an upholstered bed with generous proportions and timeless elegance. The tall, inviting headboard features refined quilted detailing that enhances its volume and softness. Available in various heights and coverings, it adapts with style to sophisticated, relaxing interiors.

design R&D Alf DaFrè





Miram letto / bed  
Pelle Lord 9340 / Lord 9340 leather  
L/W176 P/D223 H118

Timeless gruppo notte / storage units  
Laccato opaco Arena / Matt Arena lacquer  
L/W145 P/D55 H70  
L/W60 P/D45 H30,9  
→ Cat. Storage units: Timeless p. 194

Disco specchio / mirror  
Verniciato Moka shine / Moka Shine  
painted  
Ø50 P/D5,5



Miram letto / bed  
Pelle Lord 9340 / Lord 9340 leather  
L/W176 P/D223 H118





Miram letto / bed  
Tessuto Iris 605 / Iris 605 fabric  
L/W176 P/D223 H104

Malmo tavolino / occasional tables  
Laccato opaco Moka Shine / Matt Moka  
Shine lacquer  
L/W42 P/D42 H50  
→ Cat. Sofas / Occasional Tables /  
Armchairs

# MIRAM

design R&D Alf DaFrè



Miram è un letto imbottito con testiera e piattaforma sommier o con piedini. La testiera è caratterizzata da una lavorazione trapuntata.

Miram is an upholstered bed with a headboard and divan platform or feet. The headboard features a quilted finish.

Materiali e finiture  
Rivestimento: Tessuti, Pelle, Ecolpelle.

Materials and finishes  
Upholstery: Fabric, leather, ecolather.

## Misure Measurements

L176	P223	H104
L196	P223	H104
L171	P228	H104
L203	P240	H104
L211	P228	H104

## Vano rete Inner spring support size

160,5 X 202
180,5 X 202
155 X 207
187 X 219
195 X 207



## Misure Measurements

L176	P223	H118
L196	P223	H118

Disponibile anche con contenitore

## Vano rete Inner spring support size

160,5 X 202
180,5 X 202

Also available with storage unit



## Imbottito / Upholstered

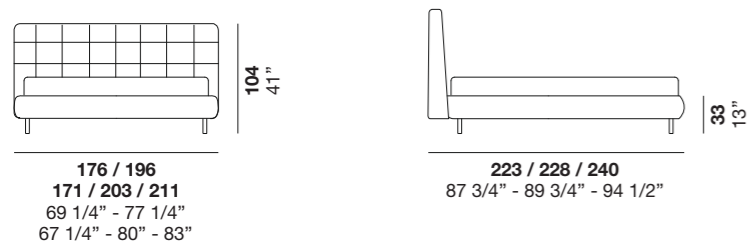

## Imbottito / Upholstered

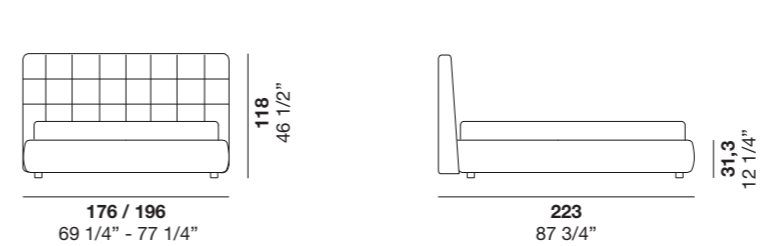

## Imbottito con piede X07 / With X07 feet

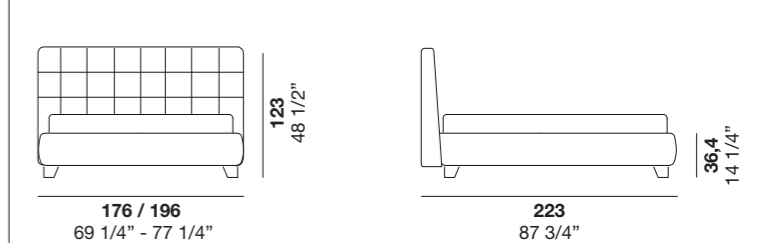

# Artur

Il letto Artur si presenta con un design contemporaneo e raffinato, capace di integrarsi armoniosamente in diversi contesti abitativi. La testiera si distingue per la fascia curvata di tessuto che la accompagna in altezza, un dettaglio distintivo che caratterizza il rivestimento e conferisce al letto una forte identità grazie alle cuciture grafiche che lo decorano. Le proporzioni equilibrate e la cura nei dettagli rendono Artur una soluzione elegante e confortevole per la zona notte.

The Artur bed features a contemporary and refined design, seamlessly integrating into a variety of living spaces. The headboard is distinguished by a curved fabric band that extends vertically, a distinctive detail that defines the upholstery and gives the bed a strong identity through the graphic stitching that decorates it. Balanced proportions and meticulous attention to detail make Artur an elegant and comfortable solution for the bedroom.

design R&D Alf DaFrè





**Artur letto / bed**  
Tessuto Regal E039 / Regal E039 fabric  
L/W240 P/D236 H118

**Denny pouf**  
Tessuto Regal E039 / Regal E039 fabric  
Ø55 H42  
→ Cat. Sofas / Occasional Tables /  
Armchairs

**Malmo tavolino / occasional table**  
Laccato opaco Moka Shine / Matt Moka  
Shine lacquer  
L/W42 P/D42 H50  
→ Cat. Sofas / Occasional Tables /  
Armchairs



Artur letto / bed  
Tessuto Antibes 903 / Antibes 903 fabric  
L/W240 P/D236 H118

Adj gruppo notte / storage units  
Fashion wood Rovere Carbone / Carbone  
oak Fashion Wood  
L/W60 P/D46 H46  
→ Cat. Storage units: Adj p. 120



**Artur** letto / bed  
Tessuto Antibes 903 / Antibes 903 fabric  
L/W240 P/D236 H118



# ARTUR

design R&D Alf DaFrè



Artur è un letto con testiera e piattaforma sommier imbottiti. Si distingue per la presenza di cuciture verticali su longoni e testiera che creano un piacevole gioco estetico.

Artur is a bed with upholstered headboard and divan platform. It features vertical stitching down the frame members and headboard, creating a playful aesthetic.

**Materiali e finiture**  
Rivestimento: Tessuti, Pelle, Ecopelle.

**Materials and finishes**  
Upholstery: Fabric, leather, ecoleather.

**Misure**  
Measurements

L240	P236	H118
L260	P236	H118
L235	P241	H118
L267	P253	H118
L277	P241	H118

**Vano rete**  
Inner spring support size

160,5 X 202
180,5 X 202
155 X 207
187 X 219
195 X 207

Disponibile anche con contenitore

Also available with storage unit

Imbottito / Upholstered

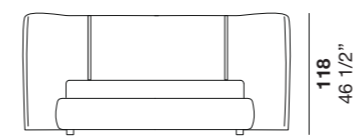

240 / 260 / 235 / 267 / 275  
94 1/2" - 102 1/4" - 92 1/2"  
105" - 108 1/4"

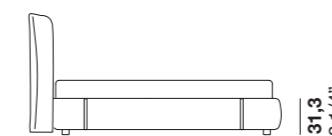

236 / 241 / 253  
93" - 95" - 99 1/2"

# Oregon 2

Oregon è un letto caratterizzato da una testiera avvolgente sulle fasce laterali che accoglie con comfort e stile, trasformando questo angolo di relax nel momento più piacevole della giornata. Le cuciture dettagliate nella parte superiore della testiera definiscono un elegante risvolto ergonomico, esaltando la qualità artigianale e il design raffinato di questo modello.

Oregon is a bed characterized by a headboard that wraps around the side panels, offering comfort and style, transforming this corner of relaxation into the most enjoyable moment of the day. The detailed stitching along the upper part of the headboard defines an elegant ergonomic fold, highlighting the artisanal quality and refined design of this model.

design Enrico Cesana





**Malmo** tavolino / occasional table  
 Top laccato micalizzato Palladio e gambe verniciato Moka Shine / Palladio micalised lacquer top and Moka Shine painted legs  
 L/W42 P/D42 H50  
 → Cat. Sofas / Occasional Tables / Armchairs

**Denny** pouf  
 Tessuto Smile 19 / Smile 19 fabric  
 Ø55 H42  
 Ø85 H37  
 → Cat. Sofas / Occasional Tables / Armchairs

**Oregon 2** letto / bed  
 Tessuto Please 503 / Please 503 fabric  
 L/W187 P/D225 H102

**Haiku** specchiera / mirror  
 Struttura verniciato Moka Shine e ripiani Nobilitato Juta / Moka Shine painted structure and Juta surfaced shelves  
 L/W50 P/D39,7 H189,7

**Timeless** gruppo notte / storage units  
 Laccato opaco Arena / Matt Arena lacquer  
 L/W60 P/D45 H36  
 → Cat. Storage units: Timeless p. 194



**Oregon 2 letto / bed**  
Tessuto Antibes 802 / Antibes 802 fabric  
L/W187 P/D225 H102

**Malmo tavolino / occasional table**  
Laccato opaco Moka Shine / Matt Moka Shine  
lacquer L/W42 P/D42 H50  
→ Cat. Sofas / Occasional Tables / Armchairs



## OREGON 2

design Enrico Cesana



Oregon 2 è un letto caratterizzato dalla particolare sagoma della testiera con parti laterali che creano un effetto di continuità estetica e funzionale. Due misure e la possibilità del contenitore completano l'offerta di questo prodotto.

Oregon 2 features an usually shaped headboard with sides that create a sense of continuity, extending the style and function of this bed. This product is available in two sizes and can include storage space.

### Materiali e finiture

Rivestimento: Tessuti, Pelle, Ecopelle.

### Materials and finishes

Upholstery: Fabric, leather, ecoleather.

### Misure

Measurements

L187	P225	H102
L207	P225	H102

Disponibile anche con contenitore

### Vano rete

Inner spring support size

160,5 × 202
180,5 × 202

Also available with storage unit

### Imbottito / Upholstered

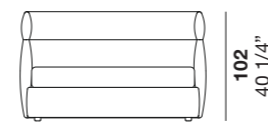

187 / 207  
73 1/2" - 81 1/2"

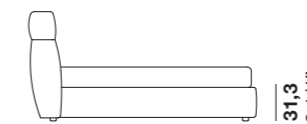

225  
88 1/2"

# Bellatrix

Bellatrix è un letto che accoglie il corpo e lo spirito in un abbraccio di morbidezza e calore. La sua testiera e piattaforma imbottite, dalle forme generose e avvolgenti, sembrano creare una cornice soffice che invita a lasciarsi andare al riposo più profondo.

Bellatrix is a bed that embraces both body and spirit in a warm and gentle hug. Its generously padded headboard and platform create a soft frame that invites you to surrender to the deepest rest.

design R&D Alf DaFrè





Bellatrix letto / bed  
Tessuto Taiga 01 colore 71/2 / Taiga 01  
fabric colour 71/2  
L/W189 P/D225 H126

By Side gruppo notte / storage units  
Fashion wood Rovere Carbone / Carbone  
oak Fashion Wood  
L/W120 P/D48 H19,5 L/W90 P/D48 H29,5  
→ Cat. Storage units: By Side p. 088



**Bellatrix letto / bed**  
Tessuto Taiga 01 colore 90/3 / Taiga 01  
fabric colour 90/3  
L/W189 P/D225 H121

**Gorge gruppo notte / storage units**  
Fashion wood Rovere Terra e top Laminam Sahara  
Noir extra lucidato / Terra oak Fashion Wood and  
Extra-glossy Laminam Sahara Noir top  
L/W60 P/D45 H47,2  
→ Cat. Storage units: Gorge p. 054



# BELLATRIX

design R&D Alf DaFrè



Bellatrix è un letto con testiera e piattaforma sommier imbottiti. Dalle forme classiche e rassicuranti, Bellatrix è disponibile con piattaforma a "terra" e con piedini che facilitano le pulizie quotidiane.

**Materiali e finiture**  
 Rivestimento: Tessuti, Pelle, Ecopelle.

**Misure**  
 Measurements

L149	P225	H121
L169	P225	H121
L189	P225	H121
L209	P225	H121

Disponibile anche con contenitore

Bellatrix is a bed with upholstered headboard and divan platform. The Bellatrix bed has a classic, reassuring shape and comes with a floor-standing platform and with feet for easy cleaning.

**Materials and finishes**  
 Upholstery: Fabric, leather, ecoleather.

**Vano rete**  
 Inner spring support size

120,5 X 202
140,5 X 202
160,5 X 202
180,5 X 202

Also available with storage unit

**Imbottito / Upholstered**

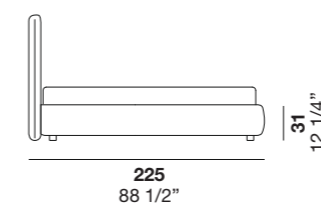
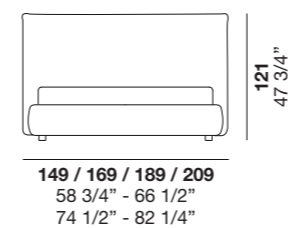

**Imbottito con piede X07 / Upholstered with X07 feet**

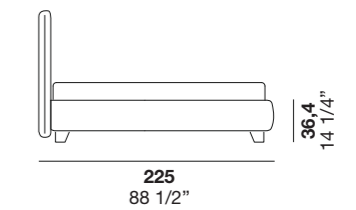
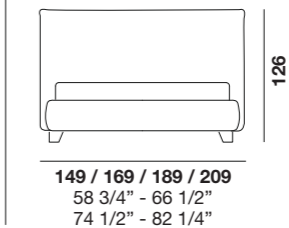

# Allen 2

Allen 2 è un letto che si distingue per la sua testiera alta e slanciata, che innalza l'eleganza dell'ambiente con un tocco di raffinata leggerezza. La lavorazione imbottita, impreziosita da una delicata cucitura a motivo esagonale, disegna una superficie armoniosa e sofisticata, capace di avvolgere con grazia il riposo. Progettato per adattarsi a ogni esigenza, Allen 2 offre un'ampia gamma di misure, anche nella versione con contenitore, unendo funzionalità e stile in un equilibrio perfetto.

Allen 2 is a bed distinguished by its tall and slender headboard, which elevates the room's elegance with a touch of refined lightness. The upholstered craftsmanship, enhanced by a delicate hexagonal stitch pattern, creates a harmonious and sophisticated surface that gracefully embraces rest. Designed to meet every need, Allen 2 offers a wide range of sizes, including a version with storage, perfectly blending functionality and style.

design Enrico Cesana





**Allen 2 letto / bed**  
Tessuto Ranger 11 / Ranger 11 fabric  
L/W186 P/D215 H128,3

**Hobby gruppo notte / storage units**  
Laccato opaco Cuoio e Basamento verniciato Moka shine /  
Matt Cuoio lacquer and Moka Shine painted base  
L/W55,7 P/D44 H42 L/W134,2 P/D52,7 H75,4  
→ Cat. Storage units: Hobby p. 168



Allen 2 letto / bed  
Tessuto Nina 28 / Nina 28 fabric  
L/W186 P/D215 H128,3

Gorge gruppo notte / storage units  
Noce naturale e top Laminam Sahara Noir  
extra lucidato / Naturale walnut and Extra-  
glossy Laminam Sahara Noir top  
L/W60 P/D45 H47,2  
→ Cat. Storage units: Gorge p. 054



## ALLEN 2

design Enrico Cesana



Allen 2 è un letto imbottito e sfoderabile caratterizzato da una testiera di altezza generosa con piacevole cucitura a motivo esagonale. Ampia la scelta di misure, anche con contenitore.

**Materiali e finiture**  
 Rivestimento: Tessuti, Pelle, Ecopelle.

### Misure Measurements

L146	P215	H128,3
L166	P215	H128,3
L186	P215	H128,3
L206	P215	H128,3
L181	P220	H128,3
L213	P232	H128,3
L221	P220	H128,3

Disponibile anche con contenitore

Allen 2 is a padded bed with removable upholstery and a tall headboard featuring hexagonal stitching. There are a wide range of sizes available, including with storage space.

**Materials and finishes**  
 Upholstery: Fabric, leather, ecoleather.

### Vano rete Inner spring support size

120,5 X 202
140,5 X 202
160,5 X 202
180,5 X 202
155 X 207
187 X 219
195 X 207

Also available with storage unit

### Imbottito / Upholstered

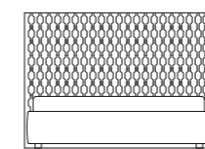

**146 / 166 / 181**  
**186 / 206 / 213 / 221**  
 57 1/2" - 65 1/4" - 71 1/4" - 73 1/4"  
 81" - 83 3/4" - 86 3/4"

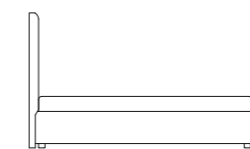

**215 / 220 / 232**  
 84 3/4" - 86 1/2" - 91 1/4"

### Imbottito con piede X07 / Upholstered with X07 feet

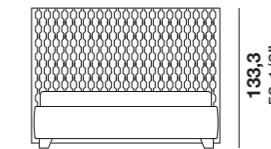

**146 / 166 / 181**  
**186 / 206 / 213 / 221**  
 57 1/2" - 65 1/4" - 71 1/4" - 73 1/4"  
 81" - 83 3/4" - 86 3/4"

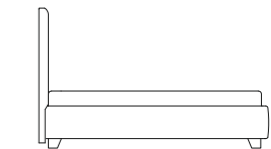

**215 / 220 / 232**  
 84 3/4" - 86 1/2" - 91 1/4"

# Dorian 2

Dorian 2 è un letto in legno dal design che reinterpreta con eleganza le forme retrò. La struttura solida e le linee pulite evocano calore e tradizione, mentre la versione con cuscini imbottiti aggiunge comfort e morbidezza alla testiera. Questo equilibrio tra robustezza e accoglienza rende Dorian 2 ideale per chi cerca un letto di design in legno autentico e funzionale.

Dorian 2 is a wooden bed with a design that elegantly reinterprets the retro shapes. Its solid structure and clean lines evoke warmth and tradition, while the version with upholstered cushions adds comfort and softness to the headboard. This balance between sturdiness and coziness makes Dorian 2 ideal for those seeking an authentic and functional wooden design bed.

design Haften Studio





Disco specchiera / mirror  
 Verniciato Moka shine / Moka Shine painted  
 Ø76,5 P/D5,5

Dorian 2 letto / bed  
 Fashion wood Rovere Terra e Tessuto  
 Nina 18 / Terra oak Fashion Wood and  
 Nina 18 fabric  
 L/W181 P/D229,3 H96,6

Da-Do system gruppo notte /  
 storage units  
 Laccato opaco Platino / Matt Platino lacquer  
 L/W148 P/D53 H74,4  
 → Cat. Storage units: Da-Do p. 130

Rim gruppo notte / storage units  
 Laccato Micalizzato Palladio / Micalised  
 Palladio lacquer  
 L/W40 P/D40 H52  
 → Cat. Storage units: Rim p. 188



Dorian 2 letto / bed  
Fashion wood Rovere Terra / Terra oak  
Fashion Wood  
L/W181 P/D220,2 H94

Rim gruppo notte / storage units  
Laccato Micalizzato Palladio / Micalised  
Palladio lacquer  
L/W40 P/D40 H52  
→ Cat. Storage units: Rim p. 188

## DORIAN 2

design Haften Studio



L'ispirazione è il recupero delle forme retrò dei letti di memoria, dalle linee sottili e dalla struttura quasi evanescente. Ma il tocco di spessori nella finitura della testata, nel disegno delle gambe e nella curvatura elegante di tutti gli elementi, lo rendono un vero pezzo di alto valore, che può essere arricchito da morbidi cuscini per la testata.

This piece is inspired by and reminiscent of the retro shapes of beds of times past, with thin lines and a structure that almost fades into the distance. The contrasting thickness in the headboard finish, leg design and omnipresent elegant curves make it a high-value piece, which can be embellished with soft headboard cushions.

### Materiali e finiture

Struttura: Laccati opachi, Fashion wood, Roveri laccati opachi.

### Materials and finishes

Frame: Matt lacquer, Fashion Wood, matt lacquered oak.

### Misure

#### Measurements

L141	P220,2	H94
L161	P220,2	H94
L181	P220,2	H94
L201	P220,2	H94

### Vano rete

#### Inner spring support size

120,5 X 200,5
140,5 X 200,5
160,5 X 200,5
180,5 X 200,5



Legno / Wood

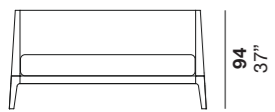

141 / 161 / 181 / 201  
55 1/2" - 63 1/2"  
71 1/4" - 79 1/4"

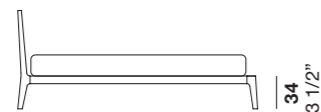

220,2  
86 3/4"

## DORIAN 2

con cuscini

design Haften Studio



### Materiali e finiture

Struttura: Laccati opachi, Fashion wood, Roveri laccati opachi.  
Cuscini: Tessuti, Pelle, Ecopelle.

### Materials and finishes

Frame: Matt lacquer, Fashion Wood, matt lacquered oak.  
Cushions: Fabric, leather, ecoleather.

### Misure

#### Measurements

L141	P229,3	H96,6
L161	P229,3	H96,6
L181	P229,3	H96,6
L201	P229,3	H96,6

### Vano rete

#### Inner spring support size

120,5 X 200,5
140,5 X 200,5
160,5 X 200,5
180,5 X 200,5



Testiera con cuscini / Headboard cushions



141 / 161 / 181 / 201  
55 1/2" - 63 1/2"  
71 1/4" - 79 1/4"

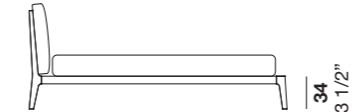

229,3  
90 1/4"

# Ecate

Ecate è un letto in legno caratterizzato da una testiera imbottita dal design minimalista e confortevole. La struttura si distingue per un elegante innesto grafico tra le gambe e la piattaforma, che ne definisce l'identità con un dettaglio unico e contemporaneo. Ecate si propone come una soluzione versatile, capace di integrarsi con stile in diversi ambienti, unendo estetica e funzionalità.

Ecate is a wooden bed distinguished by a minimally designed, comfortable upholstered headboard. The structure stands out for its elegant graphic connection between the legs and the platform, defining its identity with a unique and contemporary detail. Ecate offers a versatile solution, able to blend stylishly into various settings, combining aesthetics and functionality.

design Enrico Cesana





**Ecate letto / bed**  
 Laccato Cuoio opaco e tessuto Fado 28 /  
 Matt Cuoio lacquer and Fado 28 fabric  
 L/W173 P/D225 H98

**Olis gruppo notte / storage units**  
 Fashion wood Rovere Naturale e gola  
 laccato Cuoio opaco / Naturale oak Fashion  
 Wood and matt Cuoio lacquer groove

L/W55,2 P/D44,7 H46,4  
 L/W125,2 P/D54 H75  
 → Cat. Storage units: Olis p. 180



**Ecate** letto / bed  
Tessuto Antibes 100 e Rovere laccato  
opaco Tortora / Antibes 100 fabric and matt  
Tortora lacquer oak  
L/W173 P/D225 H98



**Ecate letto / bed**  
 Tessuto Antibes 100 e Rovere laccato  
 opaco Tortora / Antibes 100 fabric and matt  
 Tortora lacquer oak  
 L/W173 P/D225 H98

**Tuft tavolino / occasional table**  
 Laccato opaco Nero / Matt Nero lacquer  
 L/W33,2 P/D33,2 H46,3  
 → Cat. Sofas / Occasional Tables /  
 Armchairs

**Wok tavolino / occasional table**  
 Laccato opaco Tortora / Matt Tortora  
 lacquer  
 L/W27,5 P/D27,5 H50  
 → Cat. Sofas / Occasional Tables /  
 Armchairs



## ECATE

design Enrico Cesana

Registered design



Ecate è un confortevole letto caratterizzato da un'esile struttura in legno definita da morbidi raccordi, con la possibilità di personalizzare le gambe a vista. La testiera tessile, essenziale e leggermente curva, dona al letto un fascino ricercato.

Ecate is a comfortable bed, featuring a slim wooden frame with smooth joins and the option to customise the legs on show. The simple, slightly curved fabric headboard gives the bed refined charm.

### Materiali e finiture

Struttura: Laccati opachi, Fashion wood, Roveri laccati opachi.  
Testiera: Tessuti, Pelle, Ecopelle.

### Materials and finishes

Frame: Matt lacquer, Fashion Wood, matt lacquered oak.  
Headboard: Fabric, leather, ecoleather.

### Misure

Measurements

L 173 P 225 H 98

### Vano rete

Inner spring support size

160,5 X 200,5

Letto legno con testiera imbottita / Letto legno con testiera imbottita

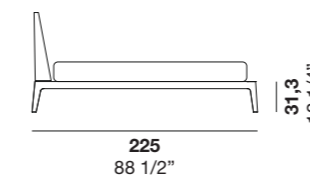
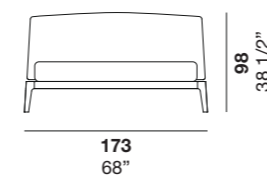

# Teo 2

Teo 2 è un letto dal design essenziale, con una testiera in legno pulita e lineare che può essere arricchita da un confortevole cuscino imbottito. Questa combinazione unisce la solidità del legno alla morbidezza del tessuto, offrendo un comfort su misura e uno stile versatile, perfetto per ogni ambiente.

Teo 2 is a bed with an essential design, featuring a clean and linear wooden headboard that can be enhanced with a comfortable upholstered cushion. This combination blends the solidity of wood with the softness of fabric, offering tailored comfort and a versatile style, perfect for any environment.

design R&D Alf DaFrè / Haften Studio





**Teo 2 letto / bed**  
Nobilitato Noce Naturale / Surfaced  
Naturale walnut  
L/W169 P/D214,5 H92,5

**Gorge gruppo notte / storage units**  
Laccato opaco Tè verde / Matt Tè Verde  
lacquer  
L/W45 P/D45 H47,2 L/W60 P/D50 H120  
→ Cat. Storage units: Gorge p. 054

**Raku panca / bench**  
Tessuto Antibes 100 e mensola Fashion  
wood Rovere Carbone / Antibes 100 fabric  
and Carbone oak Fashion Wood shelf  
L/W60 P/D50 H120 → Cat. Sofas /  
Occasional Tables / Armchairs



**Teo 2 letto / bed**  
Nobilitato Noce Naturale e Tessuto Nina 31 /  
Surfaced Naturale walnut and Nina 31 fabric  
L/W169 P/D214,5 H92,5

**Twice gruppo notte / storage units**  
Laccato opaco Nero e laccato opaco cuoio /  
Matt Nero lacquer and matt Cuoio lacquer  
L/W64 P/D47,4 H44,4  
→ Cat. Storage units: Twice p. 206

**Disco specchiera / mirror**  
Verniciato Moka shine / Moka Shine painted  
Ø76,5 P/D5,5



**Gorge** gruppo notte / storage units  
Laccato opaco Tè Verde / Matt Tè Verde  
lacquer  
L/W45 P/D45 H47,2  
→ Cat. Storage units: Gorge p. 054

**Teo 2** letto / bed  
Nobilitato Eukalipto Fossile / Surfaced  
Eukalipto Fossile  
L/W169 P/D214,5 H92



# TEO 2

design R&D Alf DaFrè / Haften Studio



Teo 2 è un letto con struttura in legno dalle forme essenziali e moderne disponibile con tre varianti di piattaforma. Il pannello testiera può essere "vestito" da un cappuccio imbottito e trapuntato disponibile in tutti i rivestimenti a campionario. Dispone inoltre di una versione con contenitore.

Teo 2 is a bed featuring a minimalist, modern wooden frame available with three different platform models. The headboard panel can be dressed with a padded, quilted hood, available in all sample box upholstery options. A version with a storage unit is also available.

**Materiali e finiture**  
Struttura: Nobilitati, Laccati opachi, Noce, Fashion wood, Roveri laccati opachi.  
Cappuccio testiera: Tessuti, Pelle, Ecopelle.

Disponibile anche con contenitore

**Materials and finishes**  
Frame: Surfaced, matt lacquer, walnut, Fashion Wood, matt lacquered oak.  
Headboard hood: Fabric, leather, ecoleather.

Disponibile anche con contenitore

## Misure Measurements

P18		
L99	P214,5	H91
L129	P214,5	H91
L149	P214,5	H91
L169	P214,5	H91
L189	P214,5	H91

## Vano rete Inner spring support size

P18	
90,5 X 200,5	
120,5 X 200,5	
140,5 X 200,5	
160,5 X 200,5	
180,5 X 200,5	

## Misure Measurements

P24		
L99	P214	H92,5
L129	P214	H92,5
L149	P214	H92,5
L169	P214	H92,5
L189	P214	H92,5

## Vano rete Inner spring support size

P24	
90,5 X 200,5	
120,5 X 200,5	
140,5 X 200,5	
160,5 X 200,5	
180,5 X 200,5	

## Misure Measurements

P22		
L99	P214	H92,5
L129	P214	H92,5
L149	P214	H92,5
L169	P214	H92,5
L189	P214	H92,5

## Vano rete Inner spring support size

P22	
90,5 X 200,5	
120,5 X 200,5	
140,5 X 200,5	
160,5 X 200,5	
180,5 X 200,5	

P18

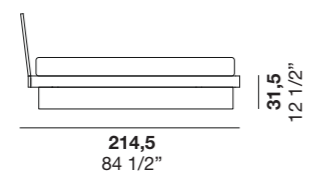
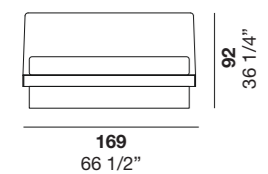
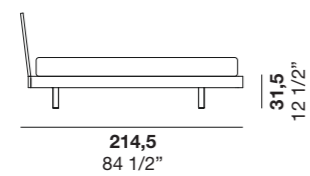
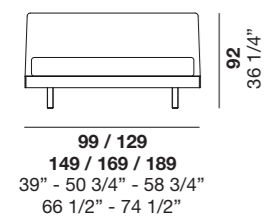

P24

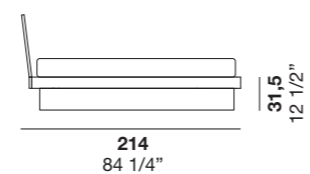
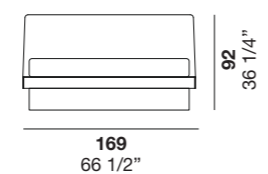
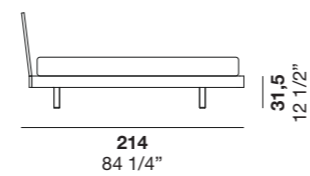
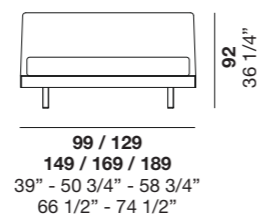

P22

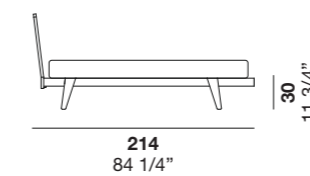
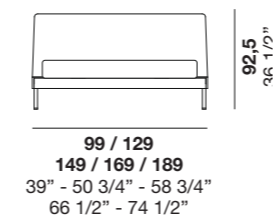

# Xilo 2

Xilo 2 è un letto in legno che unisce l'eleganza della semplicità alla forza di un design contemporaneo. La testiera, caratterizzata da un raffinato dettaglio curvato, si trasforma in un elemento iconico che definisce l'identità del letto con un tocco di armonia e originalità. Disponibile anche con testiera imbottita e piattaforma rivestita, Xilo 2 offre comfort e versatilità, capace di integrarsi con stile in qualsiasi ambiente, donando calore e carattere alla zona notte.

Xilo 2 is a wooden bed that combines the elegance of simplicity with the strength of contemporary design. The headboard, distinguished by a refined curved detail, becomes an iconic element that defines the bed's identity with a touch of harmony and originality. Also available with an upholstered headboard and a padded platform, Xilo 2 offers comfort and versatility, seamlessly integrating into any space while bringing warmth and character to the bedroom.

design Enrico Cesana





Xilo 2 letto / bed  
Noce Naturale / Naturale walnut  
L/W174,5 P/D216 H95,2

Haiku servomuto / clothes stand  
Struttura verniciato Moka Shine e ripiani  
Fashion wood Rovere Fossile / Moka Shine  
painted structure and Fossile oak Fashion  
Wood shelves L/W45 P/D45 H47,2

Ray gruppo notte / storage units  
Noce Naturale / Naturale walnut  
L/W60 P/D46,5 H46,2  
→ Cat. Storage units: Ray p. 072



Xilo 2 letto / bed  
Fashion wood Rovere Carbone / Carbone  
oak Fashion Wood  
L/W174,5 P/D216 H95,2

Timeless gruppo notte / storage units  
Laccato opaco Arena / Matt Arena lacquer  
L/W60 P/D45 H30,9  
→ Cat. Storage units: Timeless p. 194





**Xilo 2 letto / bed**  
Fashion wood Rovere Fossile e Pelle  
Scamosciata Seppia / Fossile oak Fashion  
Wood and Seppia suede  
L/W174,5 P/D216 H95,2

**Timeless gruppo notte / storage units**  
Laccato opaco Arena / Matt Arena lacquer  
L/W60 P/D45 H30,9  
L/W145 P/D55 H70  
→ Cat. Storage units: Timeless p. 194

**Esagona specchiera / mirror**  
Verniciato Moka Shine / Moka Shine  
painted  
L/W80 P/D5 H69,3



Xilo 2 letto / bed  
Fashion wood Rovere Fossile e Pelle  
Scamosciata Seppia / Fossile oak Fashion  
Wood and Seppia suede  
L/W174,5 P/D216 H95,2

## XILO 2

design Enrico Cesana



Xilo 2 è un letto con struttura in legno e piedi in metallo. Si distingue per la stondatura ai lati della testiera e per le forme decise ma leggere della piattaforma. Xilo 2 con piattaforma Soft è la variante con piattaforma rivestita in tessuto in abbinamento alla testiera imbottita.

The Xilo 2 bed has a wooden frame and metal feet. It features rounded headboard sides and a gritty, yet nimble, platform. The Xilo 2 with Soft platform model has an upholstered platform and padded headboard.

### Materiali e finiture

Struttura: Laccati opachi, Noce, Fashion wood, Roveri laccati opachi.

### Materials and finishes

Frame: Matt lacquer, walnut, Fashion Wood, matt lacquered oak.

### Misure

Measurements

L174,5 P216 H95,2

Disponibile anche con contenitore

### Vano rete

Inner spring support size

160,5 X 200,5

Also available with storage unit

Legno / Wood

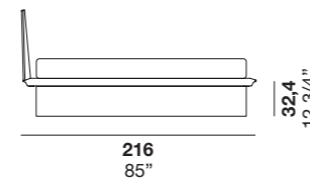
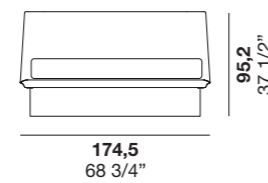
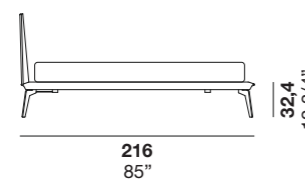
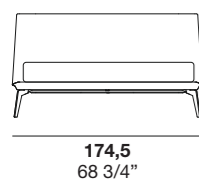

## XILO 2

con piattaforma Soft

design Enrico Cesana



### Materiali e finiture

Struttura: Laccati opachi, Noce, Fashion wood, Roveri laccati opachi.  
Testiera e rivestimenti piattaforma: Tessuti, Pelle, Ecopelle.

### Materials and finishes

Frame: Matt lacquer, walnut, Fashion Wood, matt lacquered oak.  
Headboard and platform upholstery: Fabric, leather, ecoleather.

### Misure

Measurements

L174,5 P216 H95

### Vano rete

Inner spring support size

160,5 x 200,5

Testiera imbottita e piattaforma soft / Padded headboard and upholstered platform

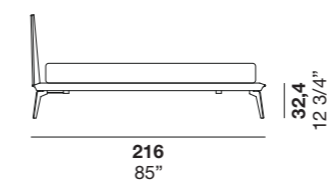
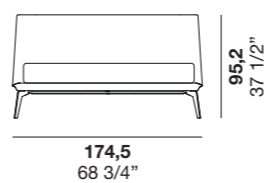

# Suite System 2

IT Un sistema pensato per creare il letto come lo vuoi tu  
EN Designed for you to create your bed the way you want it



01 → Suite System 2 con imbottitura bold e soft  
Suite System 2 with Bold and Soft padding



02 → Suite System 2 con contenitori a terra  
Suite System 2 with floor-standing storage units

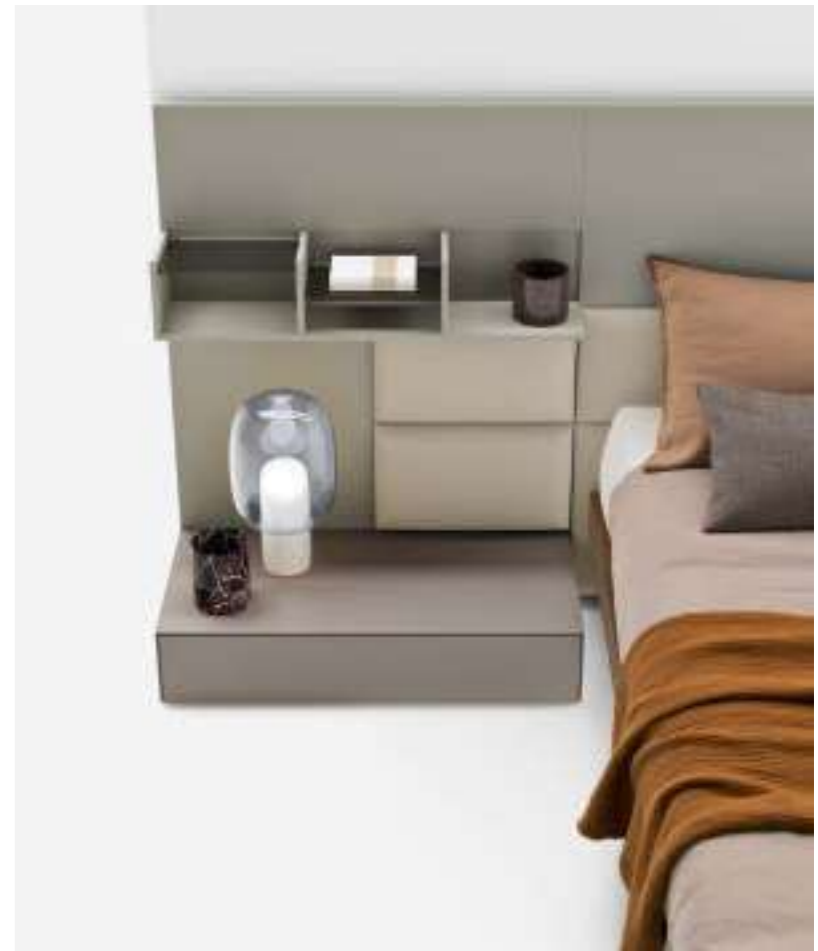

04 → Suite System 2 con vano a giorno  
Suite System 2 with open compartment



03 → Suite System 2 con luce led e mensola metallo  
Suite System 2 with LED lighting and metal shelf



05 → Suite System 2 con imbottitura soft  
Suite System 2 with soft padding



06 → Suite System 2 con porta oggetti in metallo  
Suite System 2 with metal storage compartment



**Denny pouf**  
 Pelle Lord 9120 / 9120 Lord leather  
 Ø85 H37  
 → Cat. Sofas / Occasional Tables /  
 Armchairs

**Cassiopea letto / bed**  
 Pelle Lord 9120 e Tessuto Taiga 01 colore  
 30/1 / Lord 9120 leather and Taiga 01 fabric  
 colour 30/1  
 L/W176 P/D223 H118

**Suite System 2 boiserie / wall panels**  
 Laccato opaco Fango / Matt Fango lacquer  
 SX L/W105 H45,6  
 DX L/W165 P28,4 H45,6

mensola metallo verniciato Moka shine e  
 Laminan Sahara Noir extra lucidato / metal  
 shelf Moka Shine painted and Laminan  
 Extra-glossy Sahara Noir.

**By Side gruppo notte / storage units**  
 Laccato opaco Fango / Matt Fango lacquer  
 SX L/W90 P/D48 H17,8  
 DX L/W150 P/D48 H17,8  
 → Cat. Storage units: By Side p. 088



**Cassiopea letto / bed**  
 Pelle Lord 9120 e Tessuto Taiga 01 colore  
 30/1 / Lord 9120 leather and Taiga 01 fabric  
 colour 30/1  
 L/W176 P/D223 H118

**Suite System 2 boiserie / wall panels**  
 Laccato opaco Fango / Matt Fango lacquer  
 SX L/W105 H45,6  
 DX L/W165 P28,4 H45,6

**mensola metallo verniciato Moka shine e  
 Lamin Sahara Noir extra lucidato / metal  
 shelf Moka Shine painted and Lamin  
 Extra-glossy Sahara Noir.**

**By Side gruppo notte / storage units**  
 Laccato opaco Fango / Matt Fango lacquer  
 SX L/W90 P/D48 H17,8  
 DX L/W150 P/D48 H17,8  
 → Cat. Storage units: By Side p. 088





**Miram letto / bed**  
 Pelle Lord 9340 / 9340 Lord leather  
 L/W176 P/D223 H118

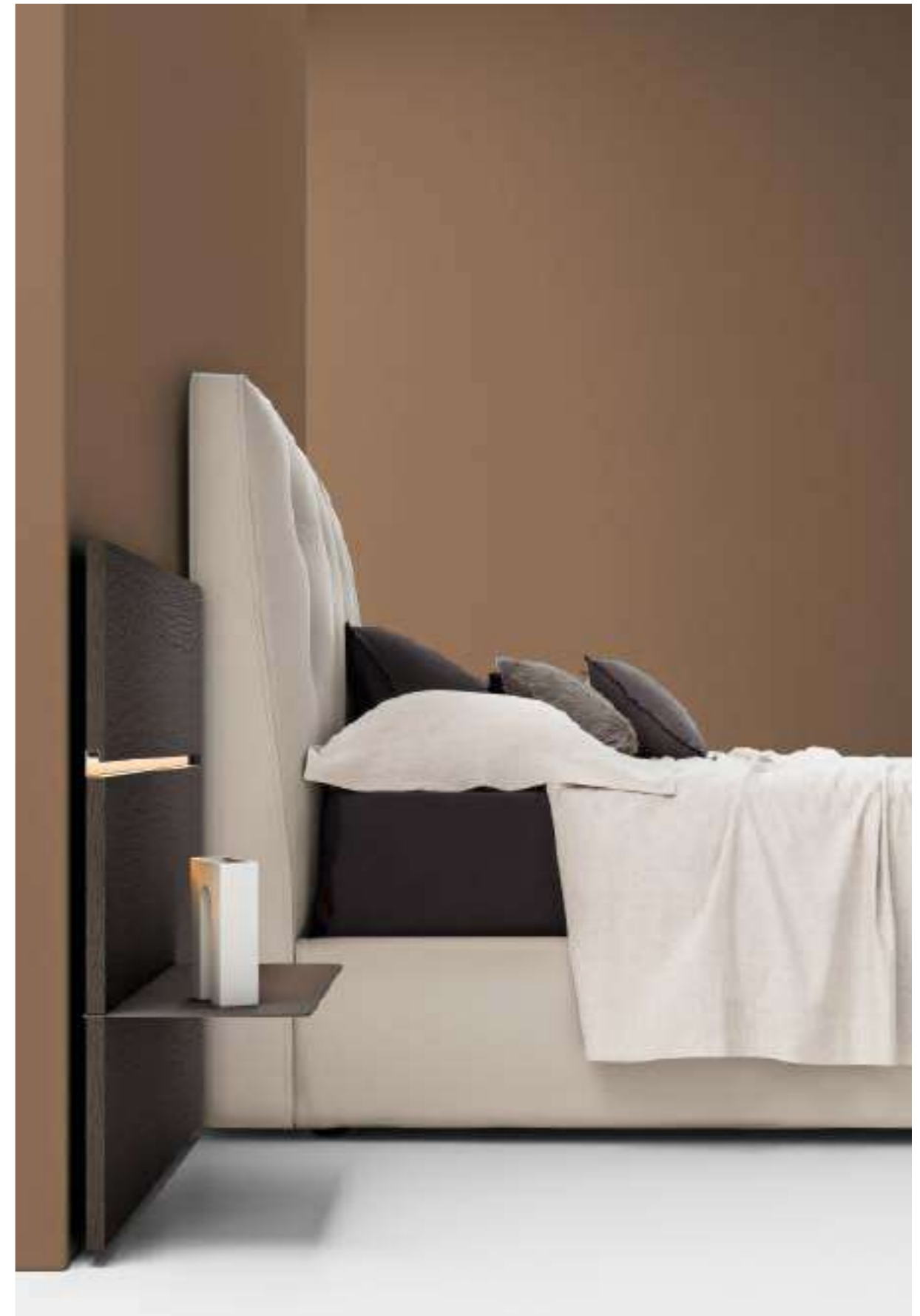

**Suite System 2 boiserie / wall panels**  
 Fashion wood Rovere Carbone / Carbone  
 oak Fashion Wood  
 SX L/W90 P/D28,4 H83,4  
 DX L/W90 H83,4

**mensola metallo verniciato Moka shine /  
 metal shelf Moka Shine painted**

**Rim gruppo notte / storage units**  
 Fashion wood Rovere Carbone / Carbone  
 oak Fashion Wood  
 L/W40 P/D40 H52  
 → Cat. Storage units: Rim p. 188



Fil vano a giorno / open unit  
Laccato opaco Cuoio / Matt Cuoio lacquer  
L/W48 P/D47,5 H27,8

Suite System 2 boiserie e vano a giorno /  
wall panel and open unit  
Fashion wood Rovere Fossile / Fossile oak  
Fashion Wood  
L/W360 P/D22,2 H73,4

P24 Piattaforma / platform  
Nobilitato Noce naturale / Surfaced  
Naturale oak  
L/W167,5 P/D204 H31,5

Fil gruppo notte / storage units  
Fashion wood Rovere Fossile / Fossile oak  
Fashion Wood  
L/W60-90 P/D48 H17,8  
→ Cat. Storage units: Fil p. 148



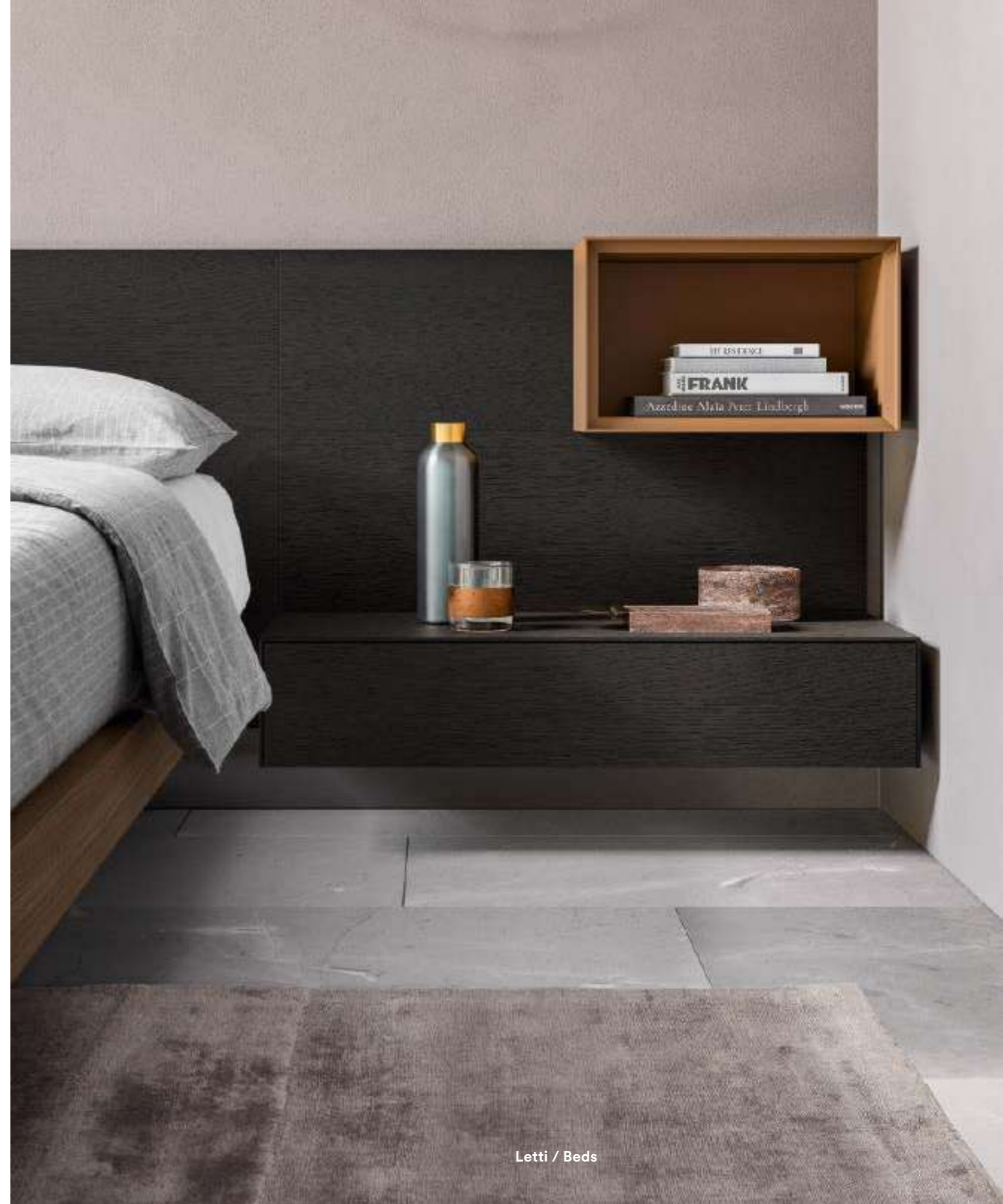



**GL07** Piattaforma / platform  
Tessuto Nina 39 / Nina 39 fabric  
L/W171,5 P/D207,5 H,31



**Suite System 2** boiserie / wall panels  
Laccato opaco Platino / Matt Platino  
lacquer  
L/W300 H83,4

**Da-Do system** gruppo notte / storage units  
Nobilitato Gurè / Surfaced Gurè  
SX L/W60 P/D45 H19,8  
DX L/W60 P/D45 H19,8  
→ Cat. Storage units: Da-Do system p. 130

Elementi appesi / Wall-mounted units  
Laccato opaco Moka Shine / Matt Moka  
Shine lacquer.  
L/W30 P/D15 H40



**Rim** gruppo notte / storage units  
Laccato opaco Platino / Matt Platino  
lacquer  
Ø40 H52  
→ Cat. Storage units: Rim p. 188

**Jet Set** poltroncina / armchair  
Tessuto Ranger 30 / Ranger 30 fabric  
L/W77 P/D87 H80

**GL07** Piattaforma / platform  
Tessuto Ranger 28 / Ranger 28 fabric  
L/W171,5 P/D207,5 H31

**Suite System 2** boiserie / wall panels  
Tessuto Ranger 28 / Ranger 28 fabric  
L/W390 P/D44 H73,4

**By Side** gruppo notte / storage units  
Laccato opaco Modica, Laccato opaco Platino  
e Laccato opaco Tortora / Matt Modica,  
Tortora and Platino lacquer  
SX L/W90 P/D48 H37,3  
DX L/W120 P/D227,2 H55,1  
→ Cat. Storage units: By Side p. 088

**Disco** specchiera / mirror  
Verniciato Moka Shine / Moka Shine  
painted  
Ø76,5 P/D5,5





**Suite System 2** boiserie / wall panels  
Tessuto Ranger 25 e Laccato opaco Fango /  
Ranger 25 fabric and matt Fango lacquer  
L/W345 H101,2

**GL07** Piattaforma / platform  
Tessuto Ranger 25 / Ranger 25 fabric  
L/W171,5 P/D207,5 H31

**By Side** gruppo notte / storage units  
Laccato opaco Fango / Matt Fango lacquer  
L/W120 P/D48 H37,3 L/W90 P/D48 H19,5  
→ Cat. Storage units: By Side p. 088





**Suite System 2** boiserie e vani a giorno /  
wall panels and open units  
Pelle Lord 9340 e Laccato opaco Aghata /  
Lord 9340 leather and matt Aghata lacquer  
L/W360 P/D22,2 H119

**P18** Piattaforma / platform  
Noce naturale / Naturale walnut  
L/W168,5 P/D204 H31,5

**Fil** gruppo notte / storage units  
Laccato opaco Arena / Matt Arena lacquer  
L/W90 P/D48 H19,8  
→ Cat. Storage units: Fil p. 148



**Suite System 2** boiserie / wall panels  
Laccato opaco Tortora e Tessuto Smile 46 /  
Matt Tortora lacquer and Smile 46 fabric  
L/W360 P/D8,7 H139

**GL06** Piattaforma / platform  
Tessuto Smile 46 / Smile 46 fabric  
L/W171,5 P/D208 H31,3

**Handy Kobe** tavolino / occasional table  
Laccato opaco Moka Shine / Matt Moka  
Shine lacquer  
→ Cat. Sofas / Occasional Tables /  
Armchairs





**Wok tavolino / occasional table**  
Laccato opaco Origano / Matt Origano  
lacquer  
L/W27,5 P/D27,5 H50  
→ **Cat. Sofas / Occasional Tables /  
Armchairs**

**Disco specchiera / mirror**  
Verniciato Moka shine / Moka Shine  
painted  
Ø50 P/D5,5

**Denny pouf**  
Tessuto Taiga 01 colore 30/1 / Taiga 01  
fabric colour 30/1  
Ø55 H42  
→ **Cat. Sofas / Occasional Tables /  
Armchairs**

**Fil gruppo notte / storage units**  
Laccato opaco Origano / Matt Origano  
L/W270 P/D48 H85,4  
→ **Cat. Storage units: Fil p. 148**

**GL07 Piattaforma / platform**  
Tessuto Smile 46 / Smile 46 fabric  
L/W171,5 P/D207,5 H31

**Suite System 2 boiserie / wall panels**  
laccato opaco Origano e Tessuto Taiga 01  
colore 30/1 / Matt Origano lacquer and  
Taiga 01 fabric colour 30/1  
L/W360 P/D19,9 H119

**Suite System 2 vano a giorno / open unit**  
Laccato opaco Tè verde / Matt Tè verde  
lacquer  
L/W 270 P/D48 H83,4

**Suite System 2 boiserie / wall panels**  
Fashion wood rovere Naturale / Naturale  
oak Fashion Wood





**Denny pouf**  
 Tessuto Nina 18 / Nina 18 fabric  
 Ø55 H42  
 → Cat. Sofas / Occasional Tables /  
 Armchairs

**Suite System 2** boiserie / wall panels  
 Tessuto Nina 18 / Nina 18 fabric  
 L/W360 P/D44 H91,2

**GL07** Piattaforma / platform  
 Tessuto Nina 18 / Nina 18 fabric  
 L/W171,5 P/D207,5 H31

**Da-Do system** gruppo notte / storage units  
 Laccato opaco Amaranto e laccato opaco  
 Nude / Matt Amaranto and Nude lacquer  
 L/W90 P/D45 H19,8 L/W90 P/D45 H37,1  
 → Cat. Storage units: Da-Do p. 130



## SUITE SYSTEM 2 / PIATTAFORME ABBINABILI

Suite System 2 / Matching platforms



Piattaforma legno P18 / P24 con piedini  
Wooden platform P18 / P24 with feet



Piattaforma legno P27 con piedini  
Wooden platform P27 with feet



Piattaforma imbottita GL07 con piedini  
Padded platform GL07 with feet



Piattaforma imbottita GL05 / GL06 Sommier  
Padded platform GL05 / GL06 Divan bed



P18



P24



P27



GL07



GL05



GL06

## SUITE SYSTEM 2 / ACCESSORI E CONTENITORI ABBINABILI

Suite System 2 / Matching accessories and storage units



Contenitore a terra  
Floor-standing storage unit



Specchiera tonda  
Round mirror



Specchiera rettangolare  
Rectangular mirror



Contenitore sospeso  
Wall-mounted storage unit



Luce led  
LED light



Porta oggetti in metallo  
Metal storage compartment



Mensola metallo  
Metal shelf



Faretto led e presa usb  
LED spotlight and USB socket



Vano a giorno  
Open compartment

## SUITE SYSTEM 2 / BOISERIE

Suite System 2 / Headboards and boiserie

## SUITE SYSTEM 2 / ESEMPI CONFIGURAZIONI

Suite System 2 / Configuration examples



Boiserie legno sospesa  
Wall-mounted wooden boiserie



Boiserie a terra  
Floor-standing boiserie



Boiserie legno a terra con libreria  
Floor-standing wooden boiserie with bookcase



SUITE SYSTEM 2  
pag. 248



SUITE SYSTEM 2  
pag. 261



SUITE SYSTEM 2  
pag. 272



Boiserie imbottita soft sospesa  
Soft wall-mounted padded boiserie



Boiserie imbottita soft a terra  
Soft floor-standing padded boiserie



Boiserie mista soft a terra  
Soft mixed floor-standing boiserie



SUITE SYSTEM 2  
pag. 252



SUITE SYSTEM 2  
pag. 262



SUITE SYSTEM 2  
pag. 276



Boiserie imbottita bold sospesa  
Bold wall-mounted padded boiserie



Boiserie imbottita bold a terra  
Bold floor-standing padded boiserie



Boiserie mista bold a terra  
Bold floor-standing mixed boiserie



SUITE SYSTEM 2  
pag. 254



SUITE SYSTEM 2  
pag. 266



SUITE SYSTEM 2  
pag. 280

# SUITE SYSTEM 2

design Enrico Cesana

Non solo un letto ma un vero sistema componibile che da ampia scelta di configurazioni e abbinamenti di finiture. Sei le piattaforme disponibili in abbinamento ai pannelli imbottiti e alle boiserie dotate di pratiche mensole in metallo. Ampia la scelta di misure, anche con contenitore.

More than just a bed, this modular composition allows you to create a wide range of configurations in a combination of finishes. There are six platforms available, which can be matched with the padded panels and boiserie fitted with functional metal shelves. There are a wide range of sizes available, including with storage space.

**P27**  
L120,5 P203  
L140,5 P203  
L165,5 P203  
L185,5 P203

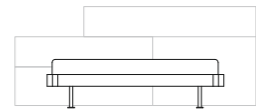

**120,5 / 140,5 / 165,5 / 185,5**  
47 1/2" / 55 1/4" / 65 1/4" / 73"



**203**  
80"

**30,2**  
12"

**P18**  
L98,5 P204,5  
L120,5 P204,5  
L140,5 P204,5  
L165,5 P204,5  
L185,5 P204,5

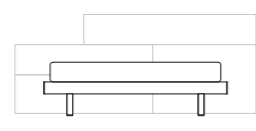

**98,5 / 128,5 / 148,5**  
**168,5 / 188,5**  
38 3/4" - 50 1/2" - 58 1/2"  
66 1/4" - 74 1/4"

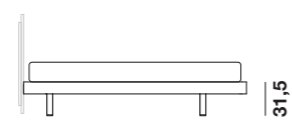

**204,5**  
80 1/2"

**31,5**  
12 1/2"

**P24**  
L97,5 P204  
L127,5 P204  
L147,5 P204

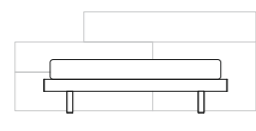

**97,5 / 127,5 / 147,5**  
**167,5 / 187,5**  
38 1/2" - 50 1/4" - 58"  
66" - 73 3/4"

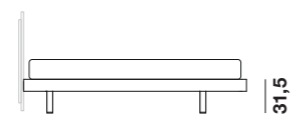

**204**  
80 1/4"

**31,5**  
12 1/2"

**GL05**  
L136,5 P210,4  
L156,5 P210,4

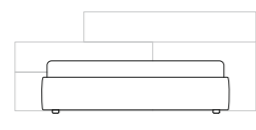

**136,5 / 156,5 / 176,5 / 196,5**  
53 3/4" - 61 1/2" - 69 1/2" - 77 1/4"

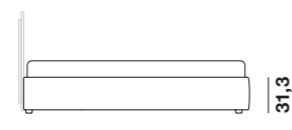

**210,4**  
82 3/4"

**31,3**  
12 1/4"

Con piede X07 / With X07 feet

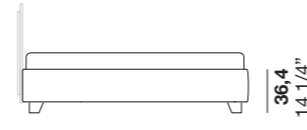

**36,4**  
14 1/4"

**GL06**  
L131,5 P208  
L151,5 P208

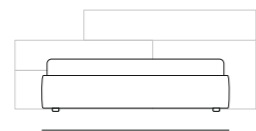

**131,5 / 151,5 / 171,5 / 191,5**  
51 3/4" - 59 3/4" - 67 1/2" - 75 1/2"

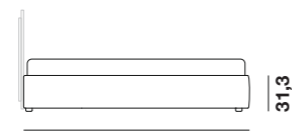

**208**  
82"

**31,3**  
12 1/4"

Con piede X07 / With X07 feet

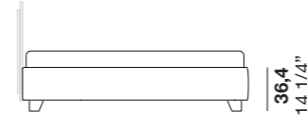

**36,4**  
14 1/4"

Legno / Wood

**GL07**  
L131,5 P207,5  
L151,5 P207,5

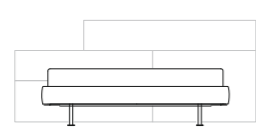

**131,5 / 151,5 / 171,5 / 191,5**  
51 3/4" - 59 3/4" - 67 1/2" - 75 1/2"

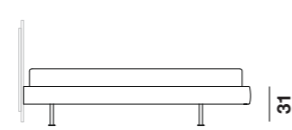

**207,5**  
81 3/4"

**31**  
12 1/4"

Boiserie / Wall panels

L 45 / 60 / 75\* / 90 / 105\* / 120 / 135 / 150 / 165 / 180 / 195 / 210 cm  
\* Nelle larghezze 75 e 105 non disponibile boiserie imbottita / In widths 75 and 105 upholstered boiserie is not available

Boiserie legno / Wooden boiserie

Boiserie legno o imbottita / Wooden or padded boiserie

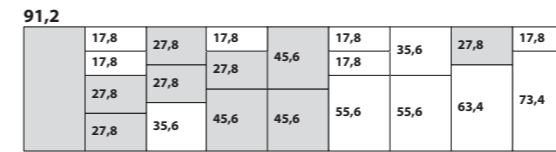
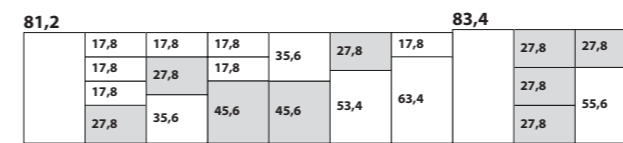
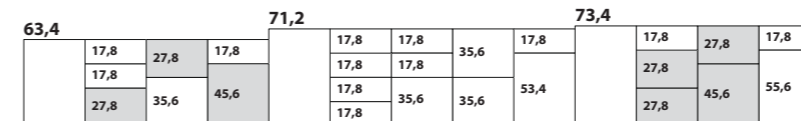
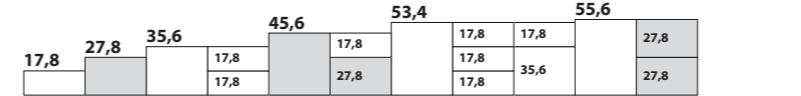

Testiera libreria / Headboard bookcase

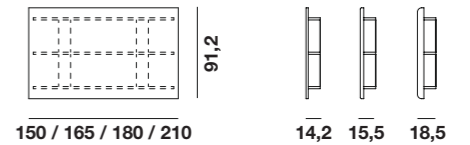

Porta accessori vani a giorno / Open accessory compartments

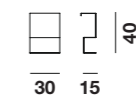

Vani a giorno / Open compartments

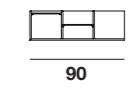
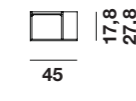

Specchiere / Mirrors

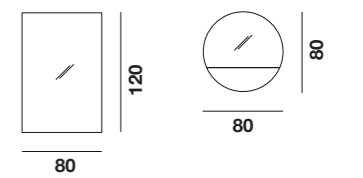

Fil moduli a giorno / Fil open units

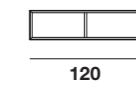
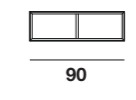
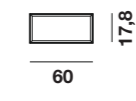
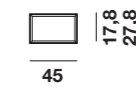

Mensole in metallo / Metal shelves

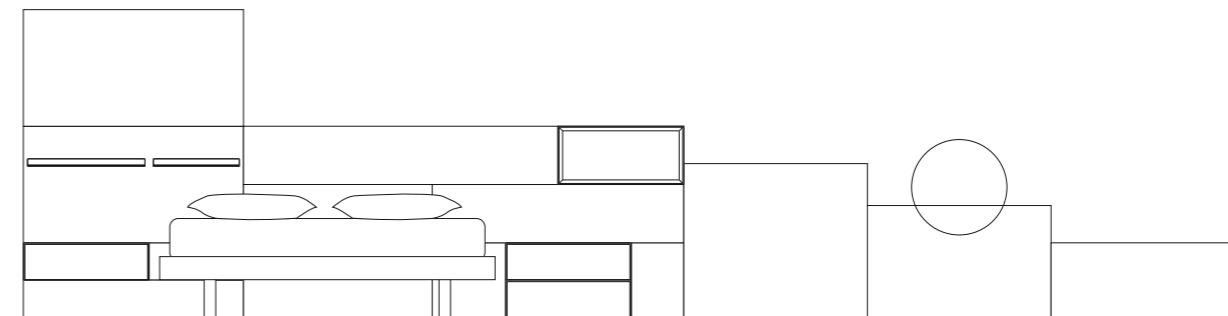
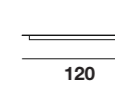
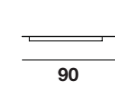
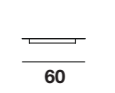
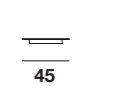

# MATERASSI

Mattresses

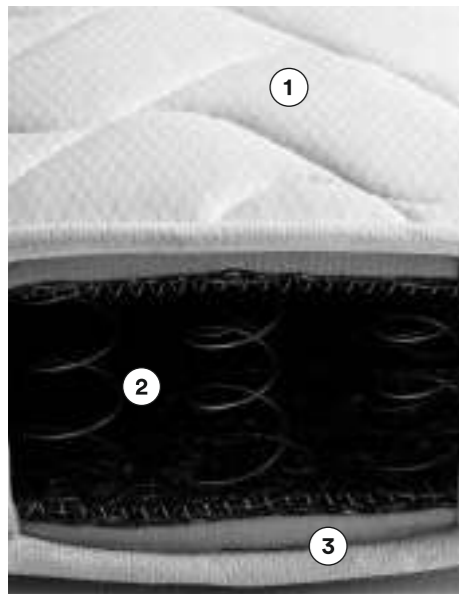

## ALF RELAX

- 1 Superficie di contatto in Elasfoam FC Fisiso Contact flessibile e traspirante massima traspirabilità. FC Fisiso Contact Elasfoam top surface that is both flexible and breathable.
- 2 Molleggio box system con 390 molle tradizionali di tipo Bonnell sostegno bilanciato. Box system springs with 390 traditional Bonnell coils for balanced support.
- 3 Imbottitura in fibre di lana, cotone e soffice tecnofibra Imbottitura a 5 strati con un cuore di aloe vera. Wool-fibre, cotton and soft synthetic-fibre padding. Five layers of padding with aloe vera at the core.



## ALF TOUCH

- 1 Superficie di contatto in Elasfoam arricchita da Memory foam in trapuntatura. Elasfoam top surface with Memory Foam in the quilting.
- 2 Struttura boxata con 700 molle insacchettate indipendenti differenziate in 7 zone. Boxed structure with 700 individual pocketed springs divided into 7 areas.
- 3 Imbottitura traspirante a 3 strati, lana, lyocell e cotone. Triple layered breathable padding: wool, lyocell and cotton.

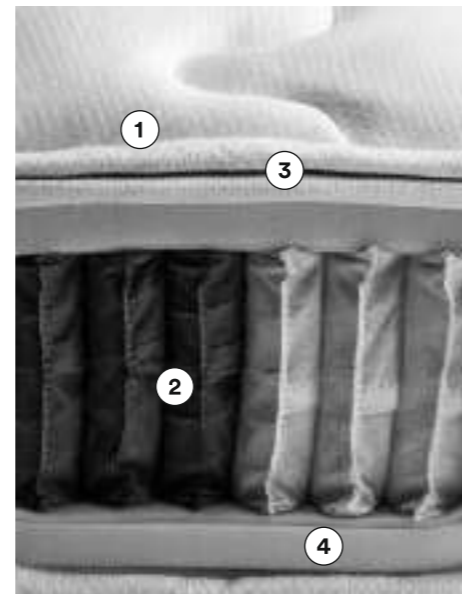

## ALF TOP

- 1 Superficie di contatto in Elasfoam con proprietà automodellanti. Elasfoam top surface that adapts its shape.
- 2 Struttura boxata con 1700 molle insacchettate indipendenti differenziate in 7 zone. Boxed structure with 1700 individual pocketed springs divided into 7 areas.
- 3 Pillow Top removibile aumenta l'accoglienza del materasso. Removable Pillow Top, making the mattress even more inviting.
- 4 Imbottitura traspirante a 3 strati, lana, lyocell e cotone. Triple layered breathable padding: wool, lyocell and cotton.

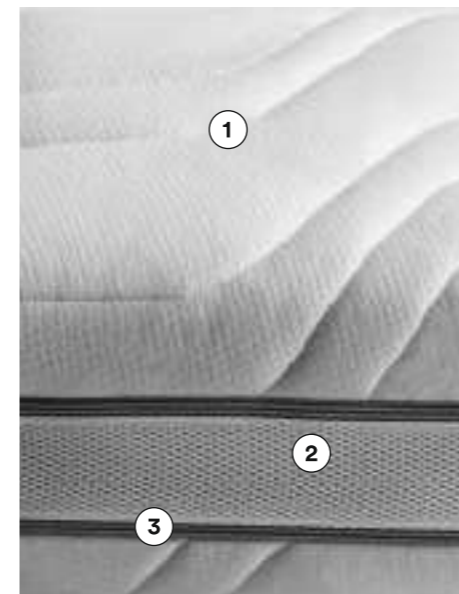

## ALF LUCK

- 1 Superficie di contatto in Memory foam regala una piacevole sensazione di accoglienza graduale. Memory foam top surface for a pleasant, gradually enveloping feel.
- 2 Struttura in Elasfoam con 7 zone differenziate con inserto in Elasfoam ad alta densità assicura un supporto ottimale. Elasfoam structure with 7 different areas and a thick Elasfoam insert for optimal support.
- 3 Imbottitura traspirante a 3 strati, lana, lyocell e cotone. Triple layered breathable padding: wool, lyocell and cotton.

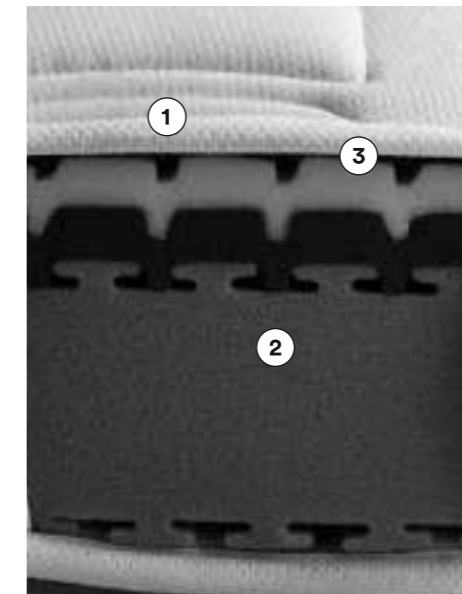

## ALF MEMORY

- 1 Superficie di contatto in Fly-Dry, una speciale schiuma antibatterica e traspirante al 100%. Top surface in Fly-Dry, an anti-bacterial, 100% breathable foam.
- 2 Struttura a 4 strati: Fly-Dry, 2 strati di Memory foam con proprietà automodellanti e 1 di flessibile e traspirante Elasfoam. Quadri-layered structure: Fly-Dry, 2 layers of self-shaping Memory Foam and 1 layer of flexible, breathable Elasfoam.
- 3 Imbottitura traspirante a 3 strati, lana, lyocell e cotone. Triple layered breathable padding: wool, lyocell and cotton.

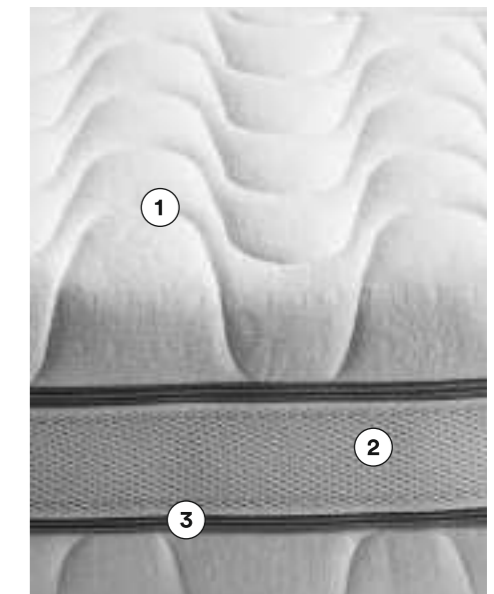

## ALF LATTICE

- 1 Struttura in schiuma di lattice a 7 zone differenziate, orono la giusta accoglienza dove serve. Latex foam structure divided into 7 different areas to provide the right level of comfort, just where you need it.
- 2 La conformazione ad alveoli del lattice conferisce elasticità, termoregolazione e la giusta ventilazione al prodotto. The cellular structure of the latex provides elasticity, heat control and the right flow of air through the product.
- 3 Tessuto in 100% cotone, fresco e sempre asciutto. Fresh, dry 100% cotton fabric.
- 4 Imbottitura a 5 strati con un cuore di aloe vera. Five layers of padding with aloe vera at the core.

## DISCO

design R&D Alf DaFrè



Specchiera Disco con cornice in metallo finitura Moka Shine. Disponibile in tre misure.

The mirror Disco has a metal frame finished in Moka Shine. Available in three sizes.



50  
19 3/4"      5,5  
2 1/4"



76,5  
30"      5,5  
2 1/4"

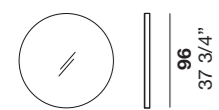

96  
37 3/4"      5,5  
2 1/4"

## ESAGONA

design R&D Alf DaFrè



Specchiera Esagona, adatta ad ogni ambiente, ha cornice in metallo finitura Moka Shine.

The mirror Esagona, suitable for any space, has a metal frame finished in Moka Shine.



80      5  
31 1/2"      2"

## FIL

design R&D Alf DaFrè



Le specchiere Fil sono dotate di una cornice in metallo di forte spessore. Disponibili in una vasta gamma di misure e finiture cornice.

The Fil mirrors have a thick metal frame. Available in a wide range of frame sizes and finishes.



45      5  
17 3/4"      2"      90 / 120 / 150  
35 1/2" - 47 1/4" - 59"

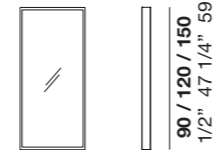

60      5  
23 1/2"      2"      90 / 120 / 150  
35 1/2" - 47 1/4" - 59"

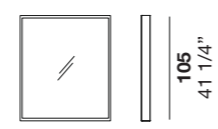

90      5  
35 1/2"      2"      105  
41 1/4"

## HAIKU

design Bruna Vaccher



Haiku è una specchiera "a terra" che nasconde pratiche funzioni, come l'appendino e il comodo ripiano disponibile in una vasta gamma di finiture.

Haiku is a floor-standing mirror unit with hidden practical features like a clothes rail and handy shelf available in a wide range of finishes.

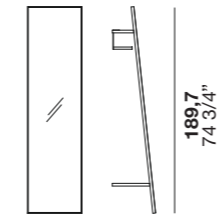

50      39,7  
19 3/4"      19"      189,7  
74 3/4"

## HAIKU

design Bruna Vaccher



Haiku servomuto è un sistema semplice per riporre gli abiti velocemente, alloggiare gli accessori che ci accompagnano durante la giornata, mantenere in ordine la stanza da letto.

The Haiku clothes stand provides a quick and simple way to put away clothes, tidy the accessories we use during the day, and keep the bedroom space tidy.

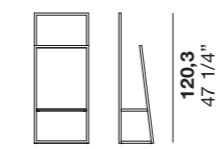

50      32  
19 3/4"      12 3/4"      120,3  
47 1/4"

## RELIEF

design Bruna Vaccher



Tappeto Relief: le proprietà brillanti della viscosa di bamboo sono utilizzate al meglio in questo esercizio di tessitura manuale contemporanea. Il volume di questa tessitura, ottenuto dai telai antichi ancora disponibili in India, risulta essere compatto, seducente e vibrante alla luce.

Relief rug: this contemporary hand-woven piece boasts a shiny finish created by the bamboo viscose material. The weave was created using ancient looms still found in India and is both compact and seductive, glimmering in the light.

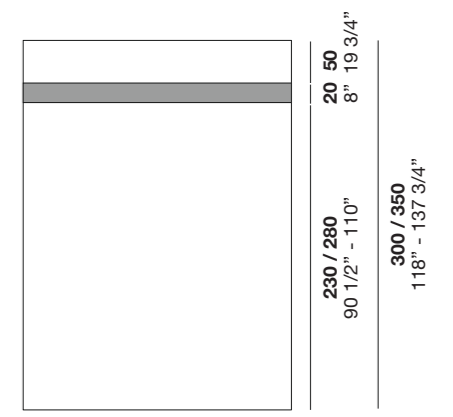

200 / 250      20 50  
78 3/4" - 98 1/2"      8" - 19 3/4"      300 / 350  
118" - 137 3/4"



02 → Studio prototipo letto Yume  
Yume bed prototype study



01 → Iris / Tessuto ecologico  
Iris / Ecological fabric



03 → Designer al lavoro sul prodotto  
Designer working on the product



04 → Magazzino prodotti finiti  
Finished product warehouse



05 → Prototipo letto Atlas  
Atlas bed prototype

**IT** Produzione tutta italiana e filiera corta dello sviluppo prototipo e produzione del prodotto, il guadagno è nei tempi, nel rispetto dell'ambiente, ma soprattutto nella valorizzazione di un territorio, che per manualità, qualità e attenzione per l'ambiente, ha sempre considerato queste condizioni come primarie.

**EN** Production in Italy and a short supply chain for developing prototypes and manufacturing products all equates to saving time, safeguarding the environment and, especially, valuing local expertise and skills. Craftsmanship, quality and care for the environment have always been of primary importance in this area.



**IT** Alf DaFrè è orgogliosa di raccontare tutta l'evoluzione nella ricerca e sviluppo dei propri prodotti, sempre attenta alle risposte da dare alle continue richieste del mercato. Una ricerca che ha lavorato sia sui materiali che sui metodi di produzione, pensati nell'ottica di favorire il processo di cambiamento ecologico in atto.

**EN** Alf DaFrè is proud to present the full evolution of its product designs: the result of attentive research and development work in response to the ongoing demands of the market. This work is focused on both materials and production methods, with a view to promoting the ecological transition underway.

## Alf DaFre®

A.L.F. Uno SpA  
Via S. Pio X 17  
31018 Francenigo di Gaiarine  
Treviso, Italy  
Tel. +39 0438 997111  
Fax Italia +39 0438 997245  
Fax estero +39 0438 997246  
www.alfdafre.it alf@alf.it



A.L.F. Uno SpA  
è certificata ISO 9001:2015  
A.L.F. Uno SpA  
is certified by the ISO 9001:2015

Verifica le finiture disponibili sul nostro sito internet / Check the finishes available on our website [www.alfdafre.it](http://www.alfdafre.it)

A.L.F. Uno SpA si riserva di apportare in qualsiasi momento modifiche a prodotti, misure e materiali, che ritenesse utili per esigenze di carattere produttivo e commerciale. Per essere sempre aggiornati vi invitiamo a consultare il nostro sito internet [www.alfdafre.it](http://www.alfdafre.it). LE FINITURE: I materiali utilizzati dalla nostra azienda sono selezionati tra i più affidabili per applicazione e resa estetica. Nonostante questo devono considerarsi tollerabili alcune differenze dovute alle caratteristiche stesse di materiali come essenze naturali, vetri, laccature e all'artigianalità di alcune fasi del processo produttivo che da sempre è un nostro valore aggiunto. Inoltre alcune finiture possono subire nel tempo maturazioni dovute all'azione della luce e del tempo. È importante quindi specificare se nell'ordine vi sono sostituzioni o completamenti per valutare insieme il miglior modo di procedere. Le tonalità di colore e le finiture illustrate vanno considerate puramente indicative. Verificare sempre la fattibilità dell'abbinamento finiture consultando l'interno del listino.

A.L.F. Uno SpA reserves the right to make any changes to products, measurements and materials at any time deemed useful for manufacturing and sales purposes. To stay up to date at all times, please visit our website [www.alfdafre.it](http://www.alfdafre.it). FINISHES: The materials we use are selected among the most reliable products in terms of application and aesthetic rendering. Despite this, certain differences due to the very characteristics of materials such as natural wood finishes, glass and lacquers must be considered tolerable, as well as the hand-crafted nature of certain phases of the production process, which has always been one of our added values. In addition, some finishes may change over time, due to the effects of light and time. It is therefore important to specify whether there are replacements or completions in the order to assess the best way to proceed together. The finishes featured in this sample collection are purely indicative and are not available for all products. Please check in the price list if the finish is available for the chosen item. Orders will not be accepted for products with finishes not included in the price list. The colour shades and finishes illustrated herein are to be considered purely indicative. Always check the feasibility of finish combinations by consulting the price list contents.

