

.collection  
2021 | 2022

**Tonin**  
CASA

# Tonin

---

## CASA

Tonin Casa in questo 2020 spegne le sue **45 candeline** di storia basata sulla **qualità** e sul **Made In Italy** che caratterizzano i suoi prodotti. Per festeggiare questo evento, Ernesto Barbieri, *CEO di Tonin Casa*, ha chiamato l'architetto *Angelo Tomaiuolo*, uno dei più importanti designer che da anni collabora con l'azienda, per **rinnovare il logo**. Ecco come lo stesso designer descrive il nuovo concept del logo.

In this 2020, Tonin Casa blows out its **45 candles** of history based on the **quality** and the **Made in Italy** that characterizes its products. To celebrate this event, Ernesto Barbieri, *CEO of Tonin Casa*, called one of the most important designers who has collaborated over the years to **restyle the logo**: the architect *Angelo Tomaiuolo*. Here is how the designer describes the new logo concept.



*"Nel concepire il restyling del logo di Tonin Casa ho immaginato di fargli indossare l'abito scuro, per esprimere la maturità e l'eleganza, che uniti all'originalità stilistica ed allo spirito innovativo, caratterizzano le collezioni del brand.*

*Ho introdotto un nuovo carattere tipografico, che meglio interpreta i valori evolutivi del marchio, utilizzando un codice semantico più classico ed autorevole.*

*Il fil rouge che segna la continuità con il passato è una sottile linea rossa, linea energetica ed orizzonte degli eventi, simbolo dello spazio umano dove si incontrano cielo e terra, ingegno e materia, creatività ed eccellenza produttiva."*

*"In conceiving the restyling of the Tonin Casa logo, I imagined to make him wear the dark suit, to express the maturity and elegance, which combined with the stylistic originality and innovative spirit, characterize the brand's collections.*

*I have introduced a new typeface, which better interprets the evolutionary values of the brand, using a more classic and authoritative semantic code.*

*The common thread that marks continuity with the past is a thin red line, energy line and event horizon, a symbol of human space where heaven and earth meet, ingenuity and substance, creativity and production excellence. "*



**sgabelli  
stools**

beetle	108
malva	112
malva élite	114
manta	116
mivida élite	118

**tavoli  
tables**

blade	006
cube	014
luxo	018
maitre	022
prime	028
style	030
tenso	040
tree	048
victory	052
zang	056

**poltrone e divani  
armchairs & sofas**

amarcord	122
anvil	126
cleo élite	128
dolce vita	134
doppio sogno	138
mama	142
moove	144
metropolis	148
sebastian	152

**vetrine e librerie  
showcases & bookcases**

archè	222
honeybook	226
kaspar	230
master	234
opera	236
plan	238
sintesi	246
venus	248

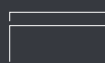
**consolle  
consoles**

cora	254
eliseo	258
eliseo élite	260
leaf	264
still	268
still élite	270

**specchiere  
mirrors**

anemos	274
daisy	278
decò	280
dorian	282
enigma	286
era ora	288
fusion	292
glamour	294
io&te	298
leave	300
lost	302
memphis	306
oblio	308
opal	310
otello	314
sottosopra	318
stone élite	320
tower	322
vogue	324

**complementi  
occasional furniture**

audrey	330
baobab	332
bloom	336
bridge	340
catullo	344
classic	346
classic big	350
cosmo	352
dedalo	356
dot	358
fidelio	360
flow	362
ginco	364
jazz	366
ledor	370
levels	374
libellula	376
line	378
madame	380
mirò	382
modì	384
oblò	392
opus	394
pacman	398
palmbeach	400
papillon	404
rendez-vous	406
rim	408
roller	412
ryazka	418
sinergy	420
snowboards	424
surf	430
venanzio	434

**lampade  
lamps**

bijoux	438
breath	440
fullmoon	444
klimt	446
mandala	450
mirò	454
shade	456

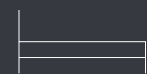
**letti  
beds**

bernini	460
havana	464
mama	468
random	472

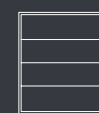
**gruppi notte  
night groups**

cubò	478
opera night	480
orazio	482

**tappeti  
rugs**

atelier	486
geometric	488

**oggettistica  
objects**

boule	492
impero	494
kaspar basket	496
plumage	498

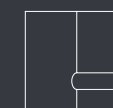
**carta da parati  
wallpapers**

wallpapers	502
------------	-----





# blade

Pierluigi Stella

Tavolo con un'unica base centrale in acciaio verniciato o dalla cover in legno che si apre verso il piano d'appoggio, con leggerezza ed eleganza, rendendolo protagonista della scena.

Table with a single central base painting steel base or with a wooden cover that opens towards the top with lightness and elegance, making it the protagonist of the scene.

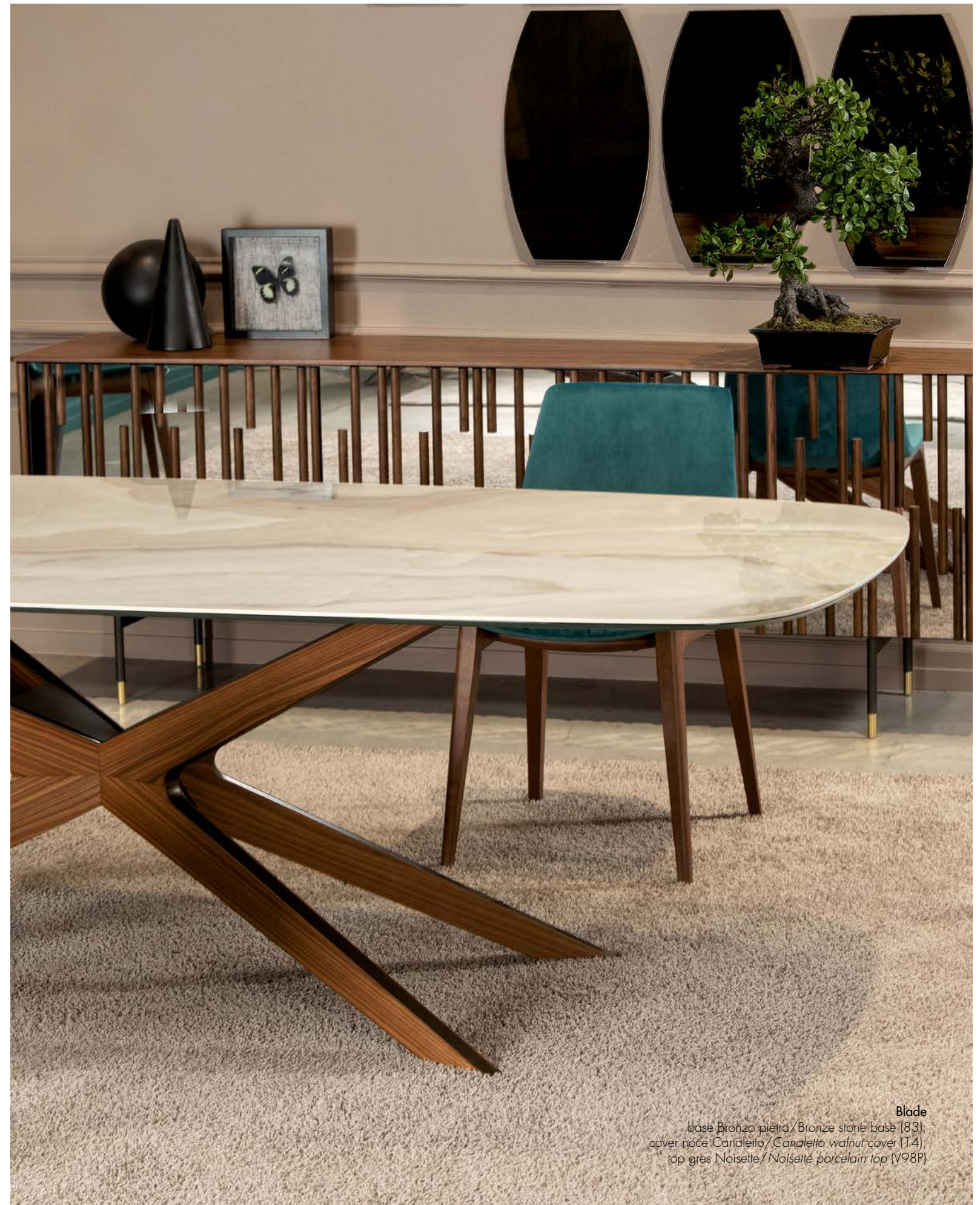
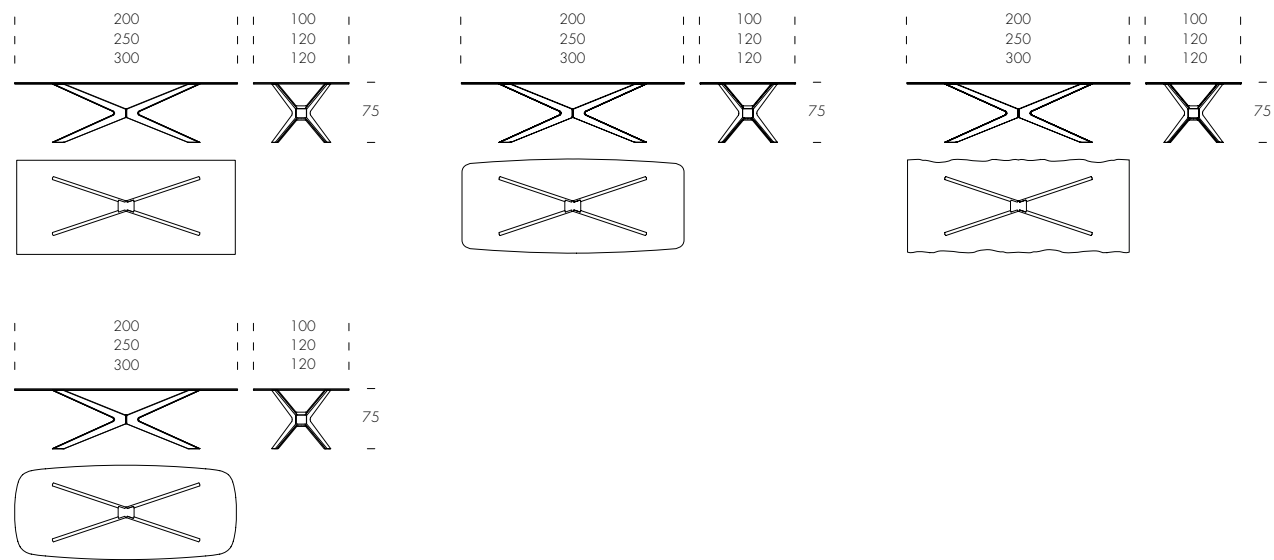

Blade  
base Bronzo pietra / Bronze stone base (183);  
cover noce Canaletto / Canaletto walnut cover (114);  
top grès Noisette / Noisette porcelain top (V98P)





**Blade**  
base grigio carbone/  
carbon grey base (110);  
top gres Terra Liquida/  
Terra Liquida top (V92P).



**Blade**

base Bronzo pietra/Bronze stone base (83);

cover noce Canaletto/Canaletto walnut cover (14);

top vetro extrachiaro trasparente bisellato/bevelled extra-clear transparent top (V100B).







**Blade**  
base bronzo pietra/ Bronze stone base (83);  
cover noce Canaletto/ Canaletto walnut cover (14);  
top gres Noisette/ Noisette porcelain top (V98P).



# cube

Cristian dal Bianco

Fisso o allungabile, Cube è un tavolo da pranzo dall'estetica decisa. La particolare sagomatura delle basi rende il tavolo raffinato, adattabile ad ogni progetto o ambiente, grazie anche alle molteplici finiture.

Fixed or extendable, Cube is a dining table with a strong aesthetic. The particular shape of the bases makes the table refined, suitable to every project or setting, thanks also to the many finishes.

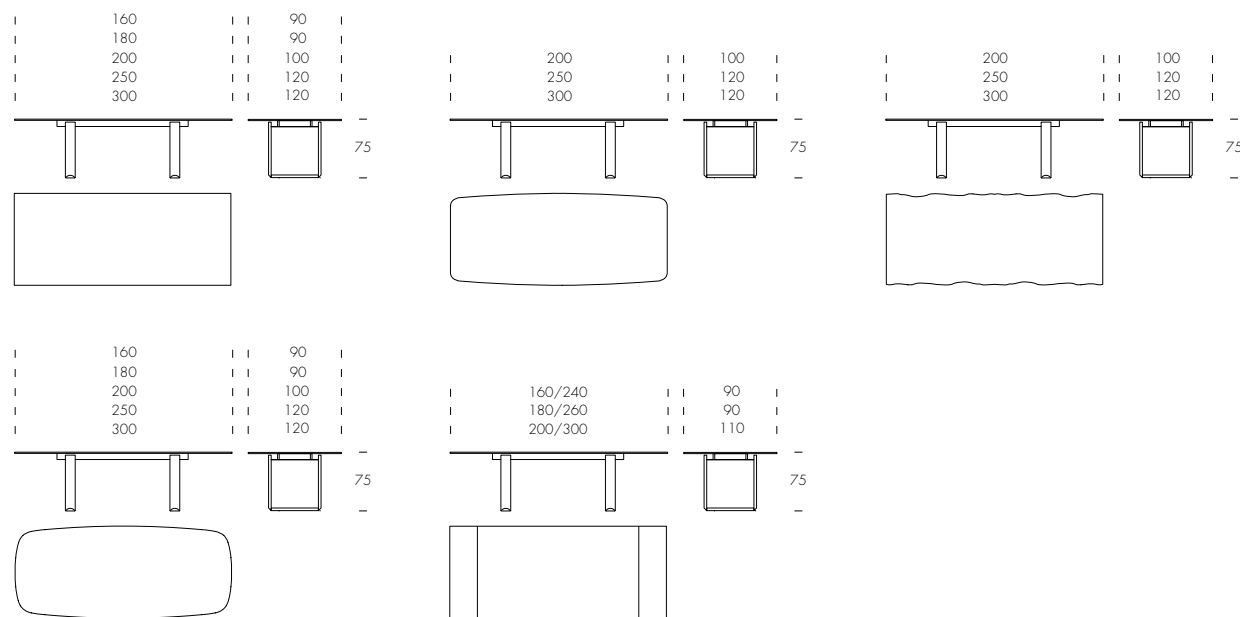





Cube  
base bronzo pietra/stone bronze base (83);  
binario grigio carbone/carbon grey guide-bar (10);  
top gres Crème opaco/matt Crème porcelain top (V91P).



# luxo

Artefatto Studio Design

Tavolo caratterizzato da un'originale struttura con base a gabbia, composta da linee verticali in acciaio verniciato, con piano rotondo in legno massello e porcellana con Lazy Susan incorporato a filo.

Table characterized by an original structure with cage base composed by vertical lines in painted steel, with round top in solid wood and porcelain with built-in Lazy Susan.

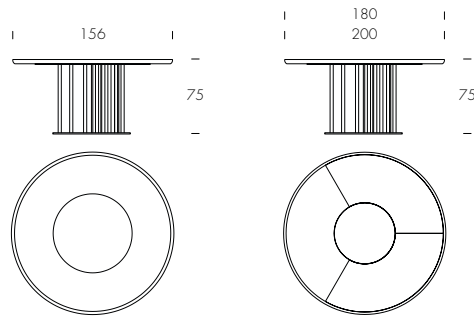





Luxo  
base grigio carbone / carbon grey base (10);  
ring frassino nero / black ash ring (25);  
top gres Macchiavecchia opaco / matt Macchiavecchia porcelain top (V88P).



# maitre

Angelo Tomaiuolo

Maitre si propone con un'imponente base a V rovesciata in acciaio verniciato gofrato, addolcita da un top in gres porcellanato racchiuso in una cornice di legno. L'impatto visivo di grandiosa raffinatezza fa di Maitre un'autentica dichiarazione di convivialità e social living.

Maitre is proposed with an inverted V-shaped embossed painted steel base, and a porcelain stoneware top enclosed in a wooden frame. The visual impact of the huge refinement makes Maitre an authentic declaration of conviviality and social living.

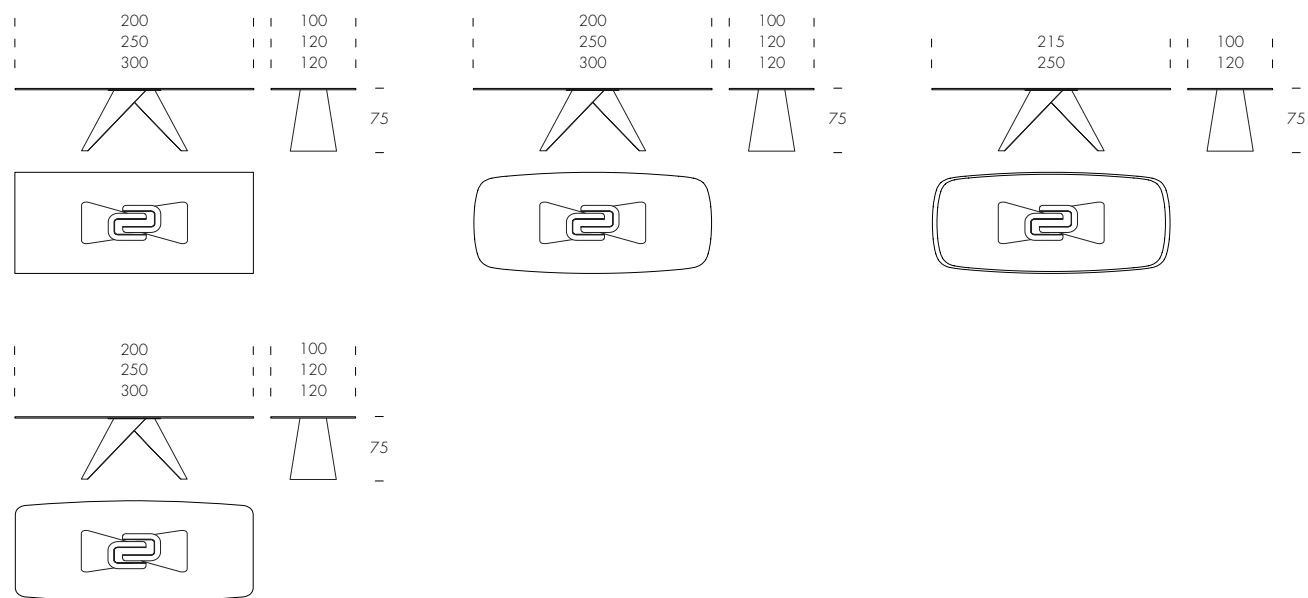





**Maitre**  
base bronzo pietra/stone bronze base (83);  
ring noce Canaletto/Canaletto walnut ring (14);  
top gres Crème opaco/  
matt Crème porcelain top (V88P).







# prime

Tonin Casa Creatives

La pienezza scultorea della base in legno termocurvato esalta la perfezione formale del piano porcellanato, incorniciato dalla finitura lignea che enfatizza ancor di più la magnificenza di Prime.

The sculptural fullness of the thermo-curved wooden base enhances the formal perfection of the porcelain top, framed by the wooden finish that emphasizes even more the magnificence of Prime.

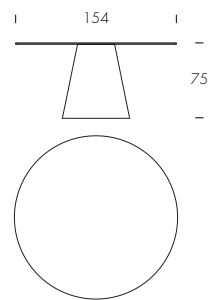

Prime  
base e ring rovere scuro/ dark oak base and ring (16);  
top gres Emperador/Emperador porcelain top (V83P).



# style

Tonin Casa Creatives

Lo stile è la peculiarità di questo nuovo ed esclusivo tavolo che si distingue per un'estetica articolata, un unicum che fonde le forme intrecciate della sontuosa base al raffinato design dei piani in gres porcellanato, vetro martellato e legno.

Style is the peculiarity of this new and exclusive table that stands out for an articulated aesthetic, an unicum that blends the interwoven shapes of the sumptuous base to the refined design of the hammered glass, porcelain stoneware and wood tops.

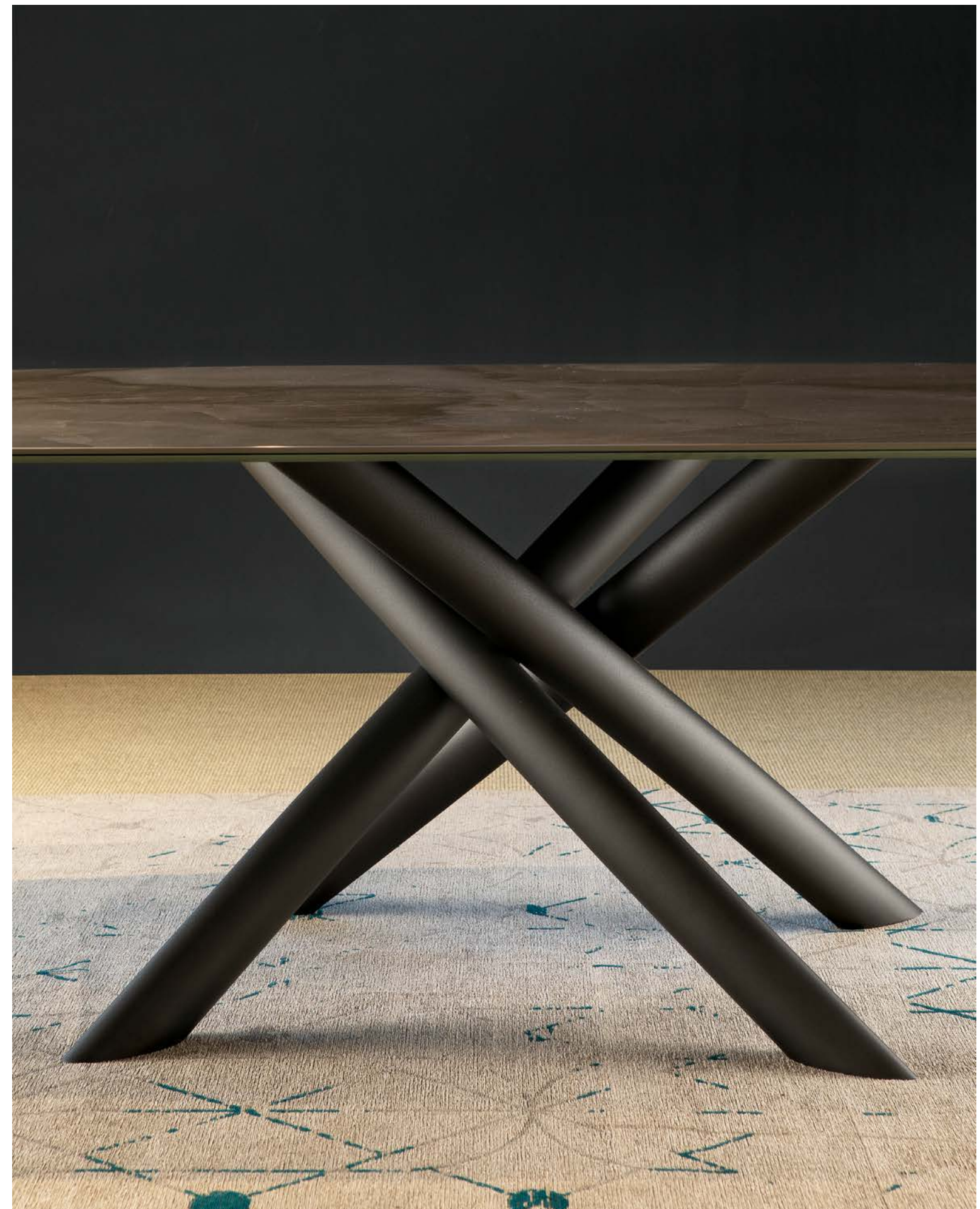
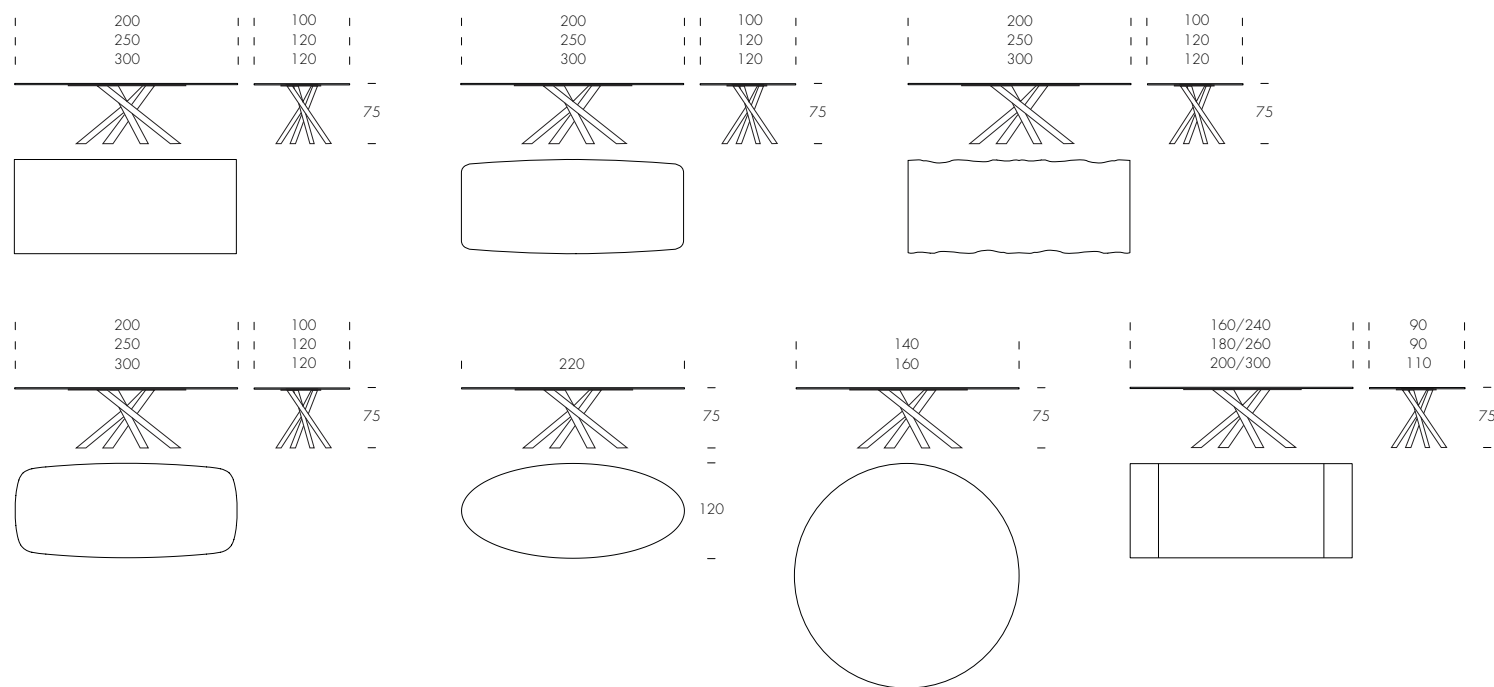





Style  
base grigio carbone/*carbon grey base* (10);  
top gres *Symphonie/Symphonie top* (V89P).





Style  
base grigio carbone / carbon grey base (10);  
top grès Choco / Choco porcelain top (V99P)





Style  
base bronzo pietra/stone bronze base (83);  
top noce Canaletto/Canaletto walnut top (14).





Base **bronzo pietra** - top botte gres porcellanato **Symphonie**  
Stone bronze base - *Symphonie* porcelain shaped top



Base **bronzo pietra** - top rettangolare vetro **martellato blu**  
Stone bronze base - blue hammered glass rectangular top



Base **bronzo pietra** - top botte gres porcellanato **Macchiavecchia matt**  
Stone bronze base - *Macchiavecchia matt* porcelain shaped top



Base **bronzo pietra** - top rettangolare vetro **martellato nero**  
Stone bronze base - black hammered glass rectangular top



Base **bronzo pietra** - top allungabile gres porcellanato **Onice Ambra**  
Stone bronze base - *Onyx Amber* porcelain extendible top

Base **bronzo pietra** - top botte **noce Canaletto**  
Stone bronze base - *Canaletto* walnut shaped top



Base **bronzo pietra** - top allungabile gres porcellanato **Statuario Altissimo**  
Stone bronze base - *Statuario Altissimo* porcelain extendible top

Base **bronzo pietra** - top rettangolare **noce Canaletto**  
Stone bronze base - *Canaletto* walnut rectangular top





# tenso

Angelo Tomaiuolo

leggero, prezioso, elegante: è Tenso, tavolo dal design iconico, che sembra scolpito con la luce e la materia. La struttura è caratterizzata da un raffinato intreccio di tubi in metallo verniciato che si intersecano e creano un design deciso, incontrando i vari top nelle diverse finiture della gamma Tonin Casa: vetro, porcellana, legno, marmo. Un tavolo dalla forte identità che si adatta perfettamente ad ogni stile di interni.

Light, precious, elegant: it is Tenso, a table with an iconic design, which seems sculpted with light and matter. The structure is characterized by a refined intertwining of painted metal tubes that intersect and create a decisive design, meeting the various tops in the different finishes of the Tonin Casa range: glass, porcelain, wood, marble. A table with a strong identity that adapts perfectly to any interior style.

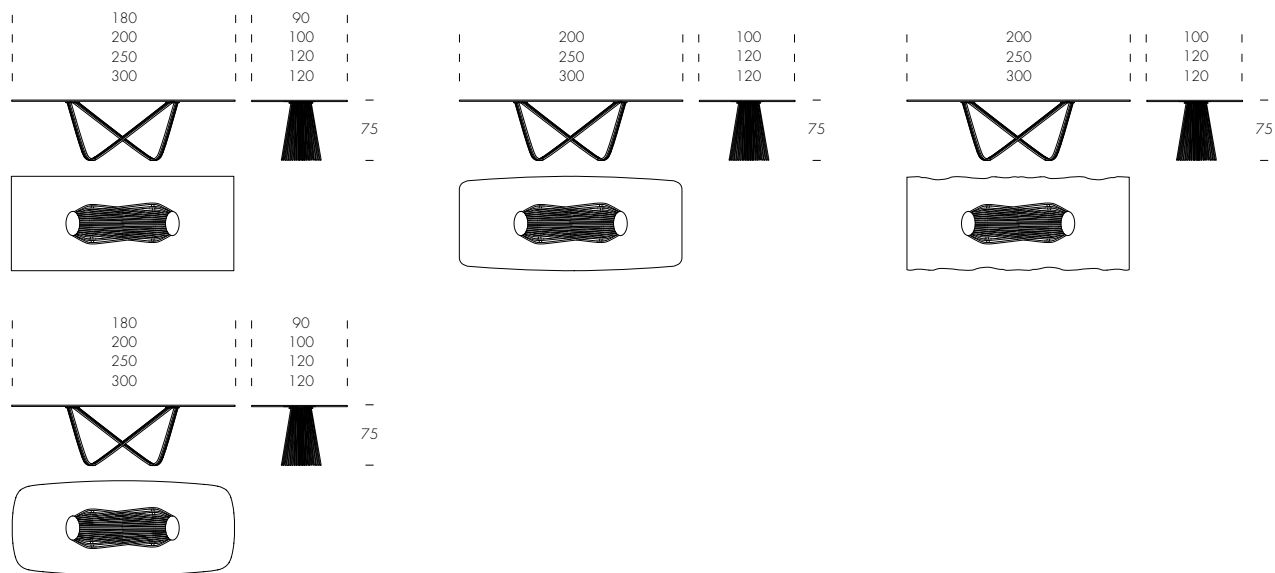



Tenso  
base oro opaco / matt gold base (8.5);  
top vetro extrachiaro trasparente bisellato / bevelled extra-clear glass top (V100B).







Tenso  
base titanio/titanium base (34);  
top gres Terra Liquida/Terra Liquida porcelain top (V92P)





**Tenso**  
base titanio/*titanium base* (34);  
top vetro martellato nero/  
*hammered black glass top* (V02M).



# tree

Pierluigi Stella

La torsione dei vari elementi metallici che costituiscono la base del tavolo Tree, crea un particolare movimento visivo di rotazione intorno al suo stesso asse. Questa nuova prospettiva sollecita una ricercatezza unica, con un design senza tempo.

The twisting of the various metal elements which constitute the base of the Tree table, creates a particular visual rotation movement around its own axis. This new perspective calls for a unique refinement with a timeless design.

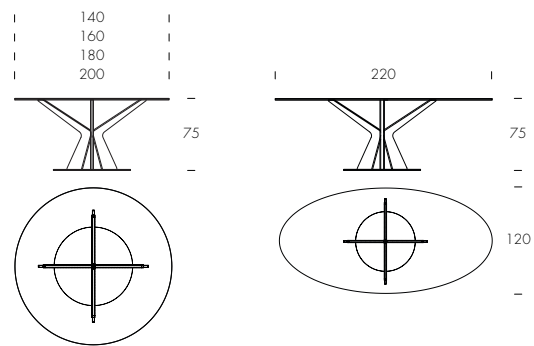

Tree  
base nero opaco/matt black base (02);  
top vetro trasparente fumè/  
transparent fumè glass top (V85).





Tree  
base bronzo pietra/stone bronze base (83);  
top vetro extrachiario trasparente/  
transparent extra-clear glass top (V100).





# victory

Cristian Dal Bianco

L'eleganza lineare e contemporanea si esprime nel tavolo Victory, dalla personalità definita, caratterizzato dall'armonico accostamento di due solide basi a V in metallo verniciato, che sostengono con leggerezza l'ampio top, personalizzabile nelle varie finiture disponibili, per una soluzione d'arredo dal grande impatto estetico.

Linear and contemporary elegance is expressed in the Victory table, with a defined personality, characterized by the harmonious combination of two solid V-shaped bases in painted metal, which lightly support the large top, that can be customized in the various finishes available, for a furniture with a great aesthetic impact.

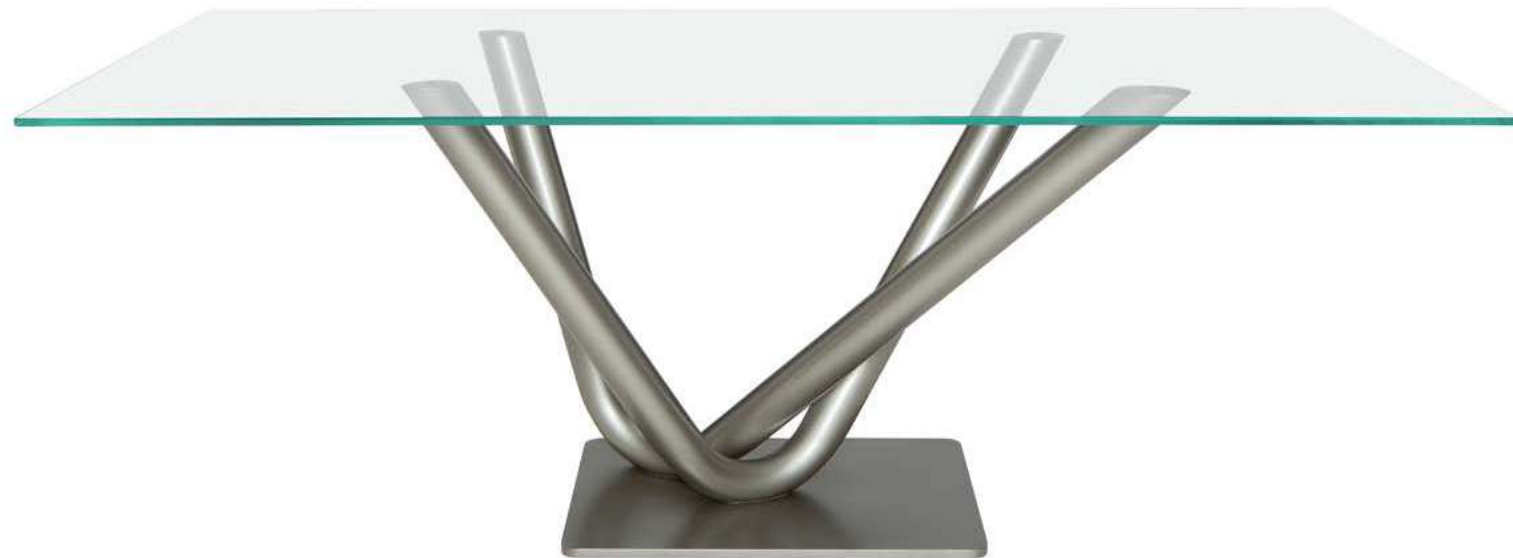
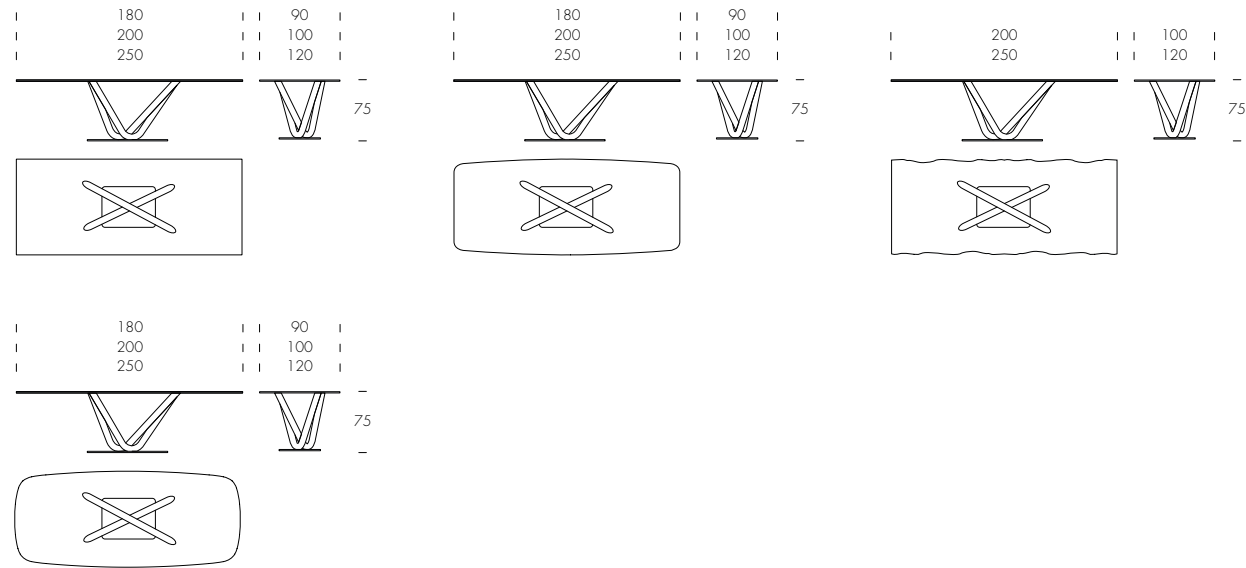



Victory  
base titanio/titanium base (34);  
top gres Porcellanato Crème opaco/Glossy Crème porcelain stoneware top (V91P).





# zang

Artefatto Design Studio

Zang è un omaggio all'opera "Zang Tumb Tumb" del futurista Marinetti. Raffinato tavolo in legno massello e marmo di Carrara, dal design rigoroso, geometrico e al contempo fluido e dinamico, grazie al movimento della base che sembra avanzare con le sue "Forme uniche della continuità nello spazio". Un effetto nuovo che arricchisce ogni ambiente.

Zang is a tribute to the futurist Marinetti's work "Zang Tumb Tumb". Refined table in solid wood and Carrara marble, with a rigorous, geometric and at the same time fluid and dynamic design thanks to the movement of the base that seems to advance with its "Unique forms of the continuity in space". A new effect that enriches any environment.

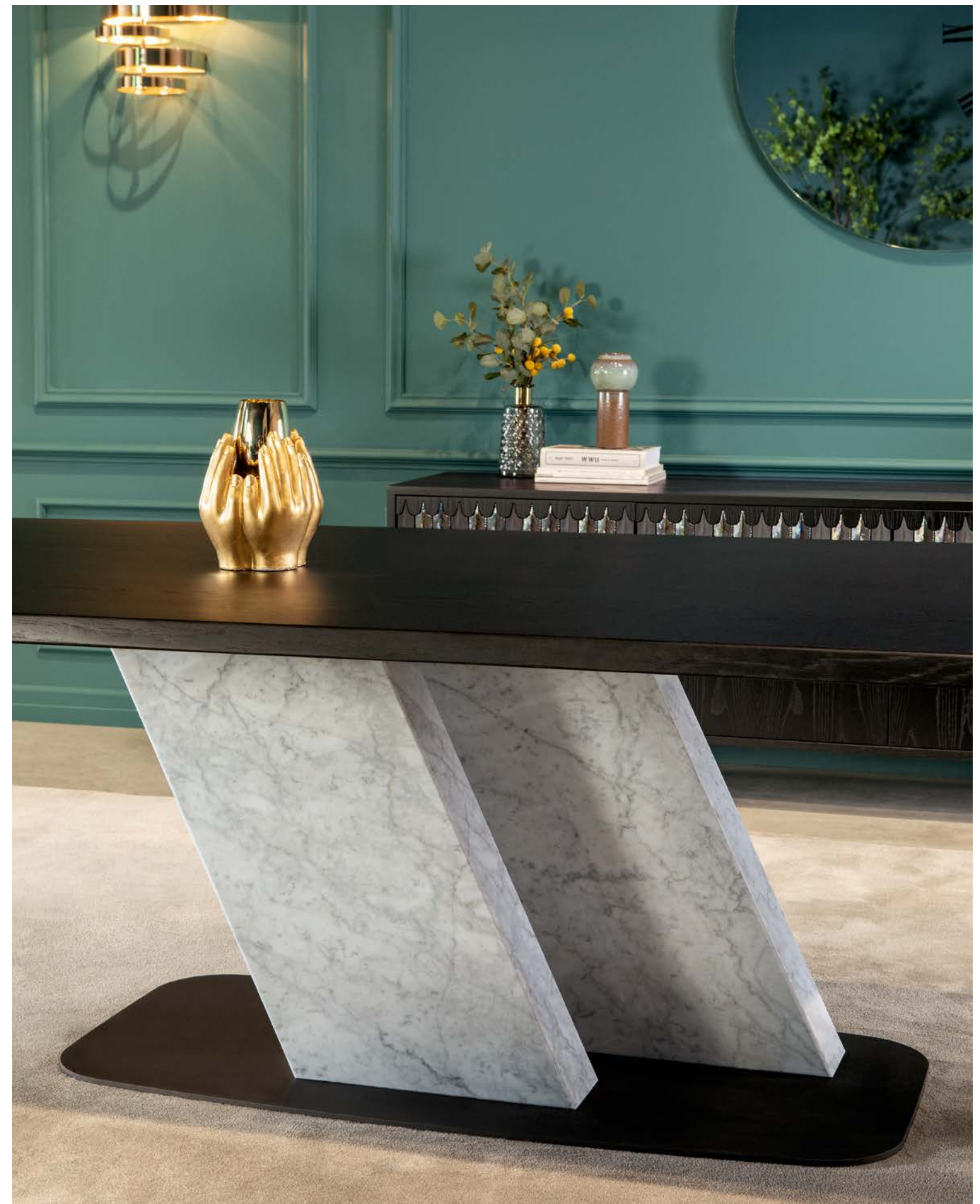
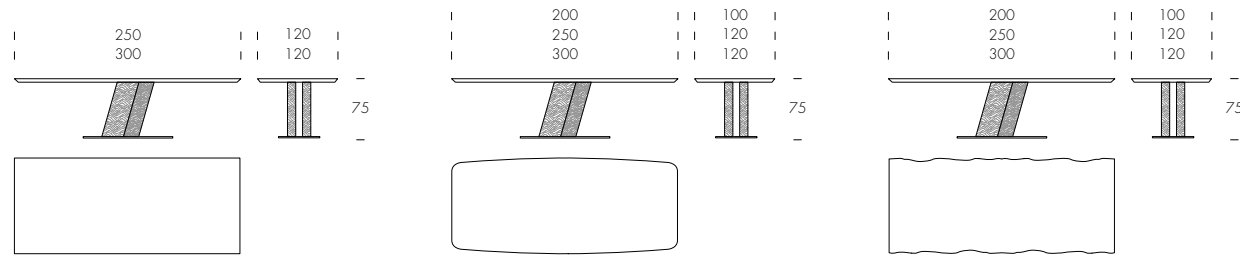



Zang  
base grigio carbone/*carbon grey base* (10);  
struttura marmo bianco Carrara/*white Carrara marble structure* (M101);  
top legno massello frassino nero/*black ash solid wood top* (LM25).







# aragona élite

Tonin Casa Creatives

Una sensazione preziosa, arricchita da finiture raffinate: è Aragona Élite, la seduta che riprende il modello iconico della collezione Tonin Casa, con una nuova elegante trapuntatura a rombi sullo schienale.

Un prodotto artigianale straordinario che unisce la struttura in legno frassino, rovere scuro e naturale a diversi rivestimenti: pelle, pelle fiore, pelle nabuk, ecopelle, tessuto.

A precious sensation, enriched by refined finishes: it is Aragona Élite, the seat that incorporates the iconic model of the Tonin Casa collection, with a new elegant rhombus pattern on the backrest.

An extraordinary handcrafted product that combines the ash, dark and natural oak wood structure with different coverings: leather, grain leather, nubuck leather, eco-leather, fabric.

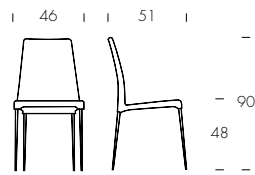

Aragona élite  
base noce Canaletto/Canaletto walnut base (14);  
rivestimento pelle beige/beige leather covering (P36).





# aria élite

Tonin Casa Creatives

Aria Élite è caratterizzata da una linea sinuosa, leggera e morbida, rivestita in cuoio con base in finitura cromo nero. Una sedia adatta ai più diversi contesti, impilabile, con scocca in stampato polimerico e struttura in metallo laccato o cromato.

Aria Élite is characterized by a sinuous, light and soft line, covered in thick leather with base in black chrome finish. A stackable chair suitable for the most diverse contexts, with molded polymer shell and lacquered or chromed metal structure.

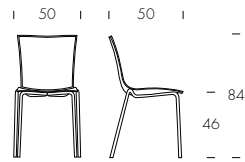

Aria élite  
base verniciato cromo nero / black chrome varnished base (76);  
rivestimento cuoio bianco e fango /  
white and mud thick leather covering (K01, K51).



# beetle

Luca Signoretti

Beetle è disponibile in versione sedia e poltroncina. Pratica, comoda ed estremamente raffinata: esile e leggera nella versione con struttura in metallo, nobile ed elegante nella versione con base in legno. Nelle sue varie combinazioni e finiture, Beetle dona un avvolgente comfort di schienale e seduta.

Beetle is the seat available in both chair and armchair version. Practical, comfortable and extremely refined: slender and light in the version with metal structure, noble and elegant in the version with wooden base. In its various combinations and finishes, Beetle gives an enveloping back and seat comfort.

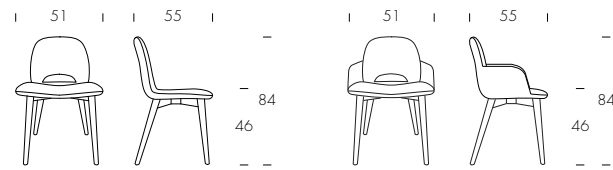

Beetle  
base grigio carbone / carbon grey base (T10);  
rivestimento velluto Vega blu profondo / deep blue Vega velvet covering (T10V).



Beetle  
base frassino nero/black ash base (25);  
rivestimento pelle grigio/  
grey leather covering (P73).





# cleo

Tonin Casa Creatives

La nuova seduta Cleo è espressione di glamour senza tempo. Confortevole e solida, curata nel dettaglio e disponibile anche nella versione con cuciture a rombo sullo schienale, che ne denotano l'artigianalità, Cleo esalta ogni spazio living con la sua identità di grande impatto. Disponibile anche nella versione Élite con elegante trapuntatura a rombi sullo schienale.

The new Cleo seat is an expression of timeless glamour. Comfortable cured in every detail it's available in the version with rhombus stitching on the back, wich underline its craftsmanship, Cleo enhances every living space with its impactful identity. Also available in the Élite version with elegant pattern on the back.

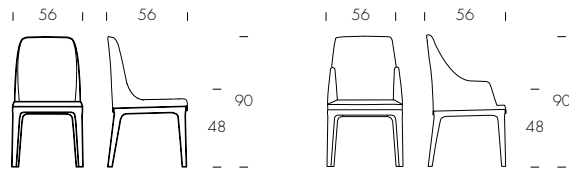

Cleo  
base noce Canaletto/Canaletto walnut base (14);  
rivestimento combinazione Grigio Lunare: tessuto Flora bianco-beige e pelle grigio/  
Grigio Lunare combination covering: white-beige Flora fabric and grey leather (05).



# cleo élite

Tonin Casa Creatives

La nuova seduta Cleo è espressione di glamour senza tempo. Confortevole e solida, curata nel dettaglio e disponibile anche nella versione con cuciture a rombo sullo schienale, che ne denotano l'artigianalità, Cleo esalta ogni spazio living con la sua identità di grande impatto. Disponibile anche nella versione Élite con elegante trapuntatura a rombi sullo schienale.

The new Cleo seat is an expression of timeless glamour. Comfortable and solid, cured in every detail it's available in the version with rhombus stitching on the back, which underline its craftsmanship, Cleo enhances every living space with its impactful identity. Also available in the Élite version with elegant pattern on the back.

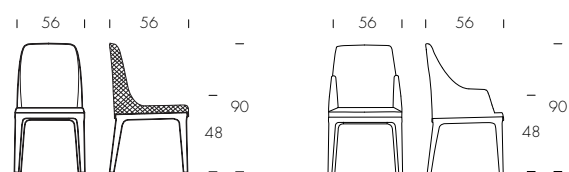

Cleo Élite  
base frassino nero / black ash base (25);  
rivestimento combinazione Grigio Intenso: tessuto Flora marrone-beige e pelle grigio /  
Grigio Intenso combination covering: brown-beige Flora fabric and grey leather (01).





Cleo Élite  
base noce Canaletto/Canaletto walnut base (14);  
rivestimento pelle blu turchese/turquoise blue leather covering (P40).





# daddy

Tonin Casa Creatives

Il capitonné è in assoluto una delle lavorazioni più pregiate e affascinanti nel mondo dell'arredamento. Questa seduta dalla linea sinuosa dona un morbido comfort ed un effetto capitonné, che la rende un unicum dall'eleganza indiscussa, unendo finiture di pelle e tessuto.

The capitonné is absolutely one of the most valuable and fascinating processes in the world of furnitures. This sinuous line seat gives soft comfort and a capitonné effect, which makes it unique with undisputed elegance, combining leather and fabric finishes.

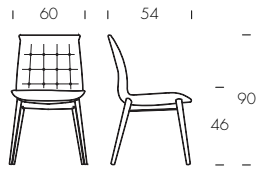

Daddy  
base bronzo pietra/stone bronze base (83);  
rivestimento pelle beige/beige leather covering (P36).



Daddy

base bronzo pietra/stone bronze base (83);  
rivestimento combinazione Grigio Intenso: tessuto Flora marrone-beige e pelle grigio/  
Grigio Intenso combination covering: brown-beige Flora fabric and grey leather (01).





# gilda élite

Angelo Tomaiuolo

Uno degli ultimi prodotti Tonin Casa da oggi si arricchisce con una nuova lavorazione che testimonia la cura e l'artigianalità che caratterizza il Made in Italy: la seduta Gilda, nella sua identità di forte impatto, è resa ancora più esclusiva con la lavorazione di trapuntatura a rombi sullo schienale.

One of the last products of Tonin Casa, now is enriched with a new process that testifies the care and craftsmanship that characterizes the Made in Italy quality: the Gilda chair in its identity with a strong impact, is made even more exclusive with the processing of the rhombus quilting on the back.

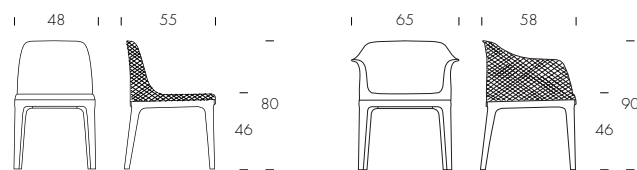

Gilda Élite  
base rovere scuro/dark oak base (16);  
rivestimento pelle nabuk panna/cream nubuck leather covering (PN05).



# glam

Luca Signoretti

La sedia Glam si distingue per le sue linee definite e per l'estetica raffinata. L'iconico schienale ne esalta il comfort, rendendo questa seduta accogliente e versatile.

The Glam chair stands out for its defined lines and refined aesthetic. The iconic back enhances its comfort making this seat cozy and versatile.

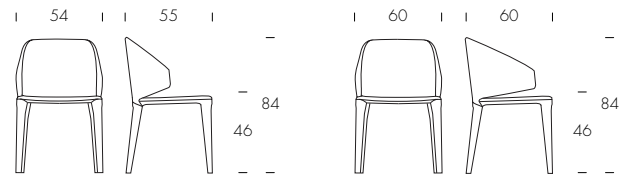

Glam  
base grigio scuro / carbon grey base (10);  
rivestimento ecopelle nabuk ecrù /  
ecrù nubuck eco-leather covering (SN03).



# hole élite

Tonin Casa Creatives

Hole Élite è una seduta dal design distintivo, rivestita in cuoio con eleganti cuciture perimetrali. La base nella nuova finitura cromo nero o nelle altre finiture esalta i vari colori disponibili per la scocca. La struttura che viene avvolta dal cuoio è in propilene, materiale che coniuga sostenibilità e resistenza.

Hole Élite is a seat with a distinctive design, covered in thick leather with elegant perimeter stitching. The base in the new black chrome finish or in the other finishes enhances the various colors available for the shell. The structure that is wrapped in leather is in propylene, a material that combines sustainability and resistance.

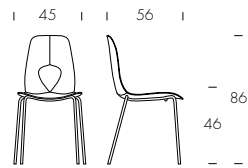

Aria élite  
base verniciato cromo nero / black chrome varnished base (76);  
rivestimento cuoio Arancio Siracusa / Siracusa orange thick leather covering (K33).





# hug

Luca Signoretti

La seduta Hug abbraccia e crea empatia grazie all'inedita curvatura e sagomatura di schienale e braccioli. Con base in metallo o in legno, la raffinatezza di questa sedia diventa un tutt'uno con l'ambiente che la circonda.

The Hug seat embraces and creates empathy thanks the unusual curvature and shaping of the back and armrests. With metal or wooden structure, the refinement of this chair becomes one with the environment that surrounds it.

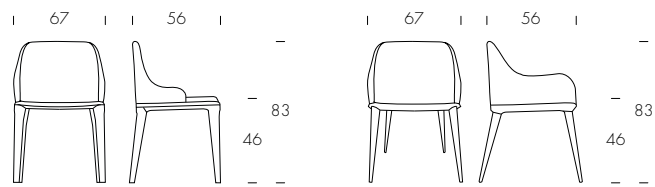

Hug  
base frassino nero / black ash base (25);  
rivestimento ecopelle nabuk ecrù / ecru nubuck eco-leather covering (SN03).

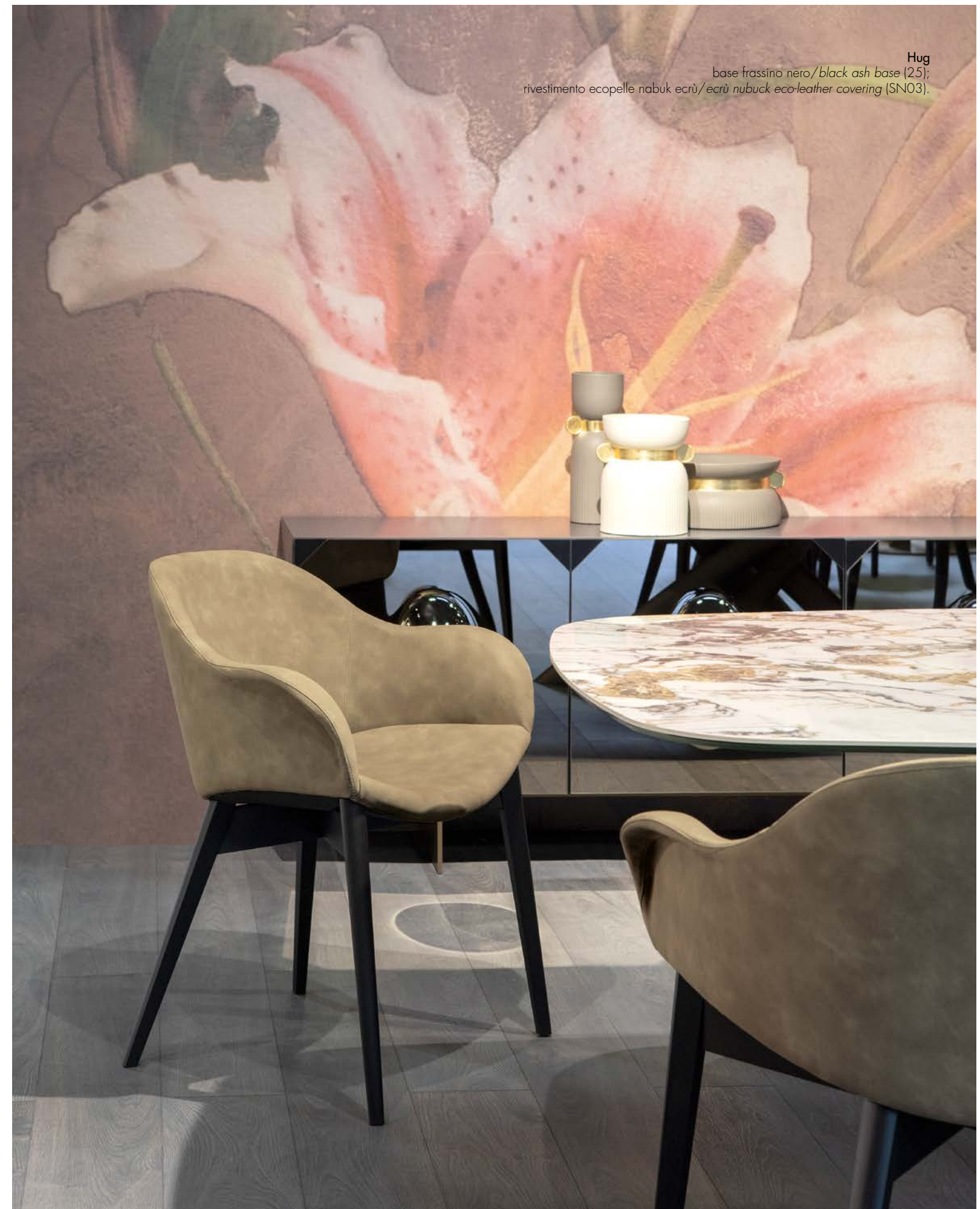



**Hug**  
base grigio carbone/*carbon grey base* (10);  
rivestimento pelle nabuk fango/*mud nubuck leather covering* (PN51).





# manta

Plurimo Design

Manta è la combinazione perfetta tra funzionalità e design. Il cuoio riveste questa seduta dalla forte personalità: con la sua forma morbida creata dalla curvatura del legno, Manta funge da sedia e da poltroncina allo stesso tempo.

Manta is the perfect combination of functionality and design. The thick-leather covers this seat with a strong personality: with its soft shape created by the curvature of the wood, Manta acts as a chair and an armchair at the same time.

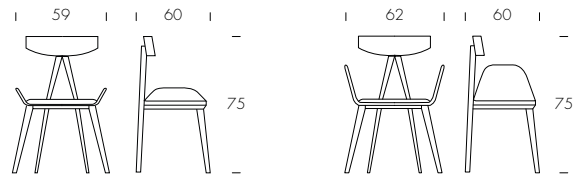

Manta  
base rovere scuro/dark oak base (16);  
rivestimento cuoio lavanda e grigio/  
lavander and grey thick leather covering (K52, K29).



# mivida élite

Angelo Tomaiuolo

Uno dei best seller Tonin Casa da oggi si arricchisce di una nuova lavorazione che testimonia la cura e l'artigianalità che caratterizzano il Made in Italy: la seduta Mivida, di forte impatto, è resa ancora più esclusiva grazie alla lavorazione di trapuntatura a rombi sullo schienale.

One of the best seller of Tonin Casa, from today it is enriched with a new process that testifies the care and craftsmanship that characterizes the Made in Italy quality: the Mivida chair with a strong impact, is made even more exclusive thanks to the processing of the rhombus quilting on the back.

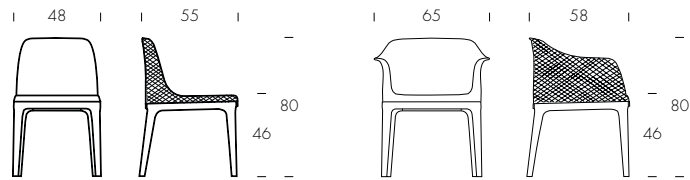

Mivida Élite  
base noce Canaletto / Canaletto walnut base (14);  
rivestimento pelle lavanda / lavender leather covering (P52);  
cordonatura ecopelle testa di moro / dark brown eco-leather covering (S70).







pop

Tonin Casa Creavites

La sedia Pop, di estrema semplicità formale, regala a prima vista una sensazione di armonia grazie alle sue linee pulite e ben calibrate, che la rendono un passepartout per ogni ambiente. Disponibile in due misure di schienale e in molteplici materiali e finiture di colore.

The Pop chair, of extreme formal simplicity, gives at first sight a feeling of harmony thanks to its clean and well-balanced lines, which make it a passepartout for any environment. Available in two backrest sizes and in multiple materials and color finishes.

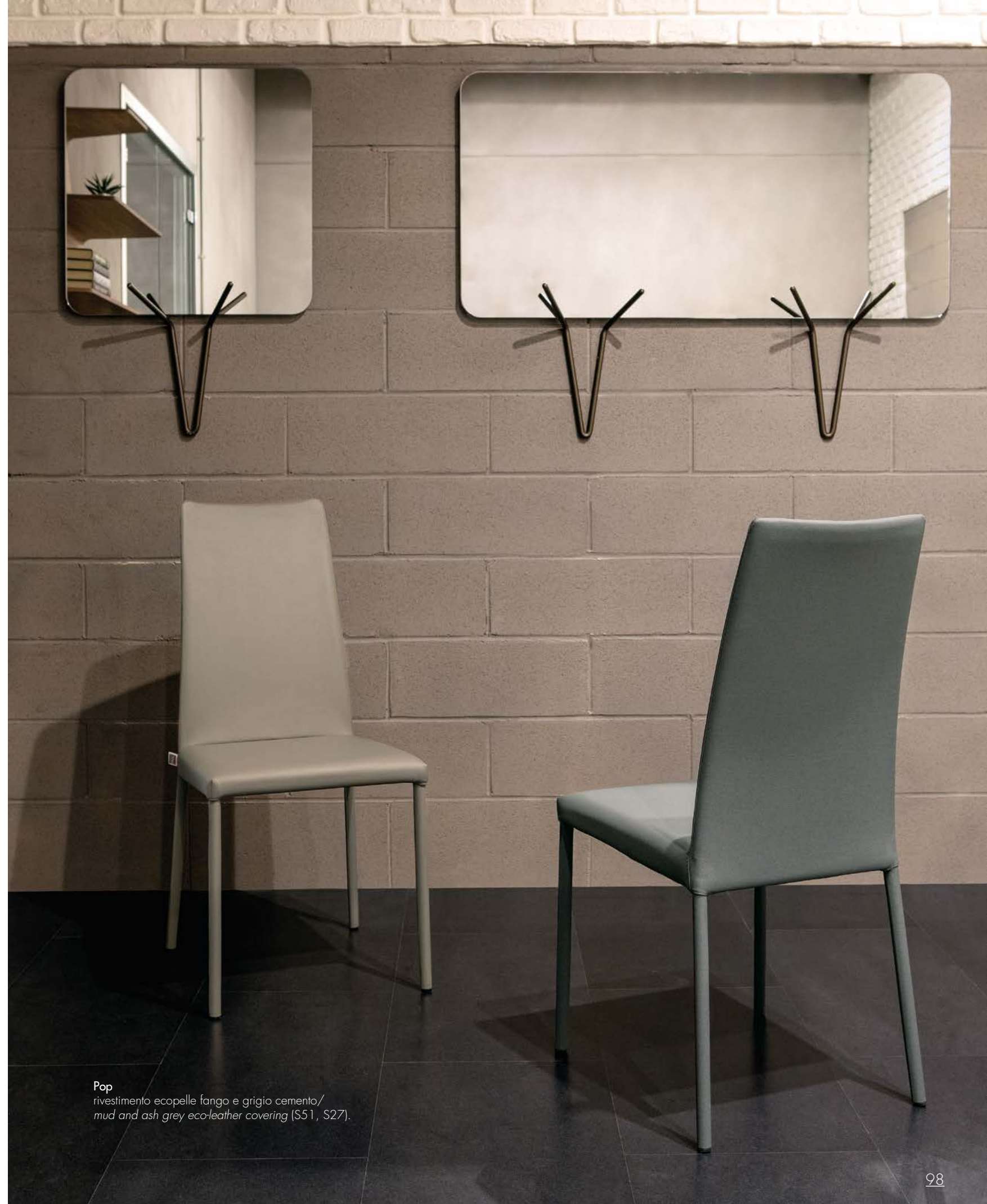
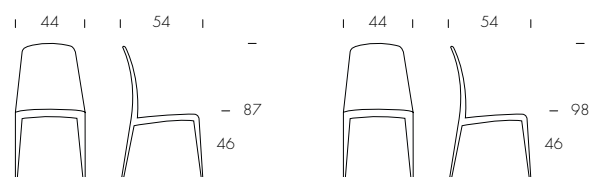

Pop  
rivestimento ecopelle fango e grigio cemento/  
mud and ash grey eco-leather covering (S51, S27).





Pop  
rivestimento ecopelle fango/  
mud eco-leather covering (S51).



# sofia

Luca Signoretti

La sapiente lavorazione della sedia Sofia regala una sensazione di armonica bellezza, impreziosita da dettagli sofisticati: dalla particolarità dello schienale che termina con una curvatura a ricciolo, alle cuciture a rilievo che ne denotano la sartorialità. La seduta generosa è arricchita da un materassino che la rende particolarmente confortevole e accogliente.

The skilful workmanship of the Sofia chair gives a feeling of harmonious beauty, embellished with sophisticated details: from the peculiarity of the backrest that ends with a curl curve, to the raised seams that denote its tailoring. The generous seat is enriched by a mattress that makes it particularly comfortable and welcoming.

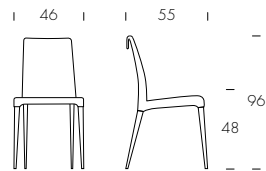

Sorrento Office  
struttura bronzo pietra / stone bronze structure (83)  
rivestimento pelle beige / beige leather covering (P36).



# sorrento ésprit swivel

Tonin Casa Creavites

Accomodatevi nella nuova Sorrento Ésprit Swivel, una seduta confortevole, funzionale, dall'alto valore estetico che dona preziosità ad ogni tipo di ambiente. Raffinata e versatile, con base girevole in alluminio verniciato nero opaco, Sorrento Ésprit Swivel crea un sofisticato connubio tra comfort ed eleganza.

Take a seat in the new Sorrento Ésprit Swivel, a comfortable, functional seat with a high aesthetic value that gives preciousness to any type of environment. Refined and versatile, with a swivel base in matt black painted aluminum, Sorrento Ésprit Swivel creates a sophisticated combination of comfort and elegance.

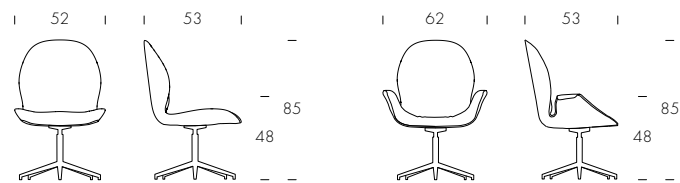

Sorrento Ésprit Swivel  
rivestimento pelle panna / cream leather covering (PO5).





# sorrento office

Tonin Casa Creavites

Sorrento Office, la combinazione perfetta tra funzionalità ed eleganza, per donare comfort e prestigio al proprio luogo di lavoro. La base con cinque ruote gommata sostiene l'ergonomia della seduta oscillante, caratterizzata da un sistema elevante che conferisce ineguagliabile dinamicità alla seduta.

Sorrento Office, the perfect combination of functionality and elegance, to give comfort and prestige to your workplace. The base with five rubber wheels supports the ergonomics of the oscillating seat, characterized by an elevating system that gives unparalleled dynamism to the seat.

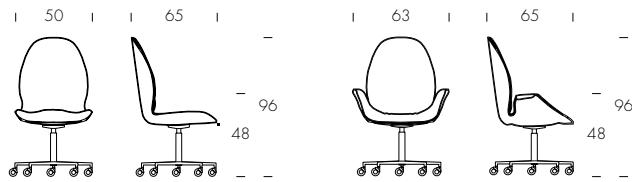

Sorrento Office  
rivestimento pelle grigio/grey leather covering (P73);  
cordonatura ecopelle tortora/dove grey eco-leather creasing (S60).









# beetle

Luca Signoretti

Beetle, oltre che sedia e poltroncina è disponibile anche in versione sgabello. Pratico, comodo ed estremamente raffinato: esile e leggero nella versione con struttura in metallo, nobile ed elegante nella versione con base in legno. Nelle sue varie combinazioni e finiture, Beetle dona un avvolgente comfort di schienale e seduta.

In addition to the chair and armchair, Beetle is also available in a stool version. Practical, comfortable and extremely refined: slender and light in the version with metal structure, noble and elegant in the version with wooden base. In its various combinations and finishes, Beetle gives an enveloping back and seat comfort.

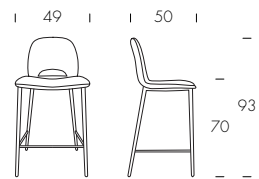

Beetle  
base noce Canaletto/Canaletto walnut base (14);  
rivestimento pelle champagne/champagne leather covering (P61).







# malva

Andrea Lucatello

La seduta Malva si propone in versione sgabello, unico ed elegante: le linee definite, i braccioli curvati e la base slanciata donano un'identità decisa allo spazio living.

The Malva seat is proposed in a stool version, unique and elegant: the defined lines, the curved armsets and the slender base give a decisive identity to the living space.

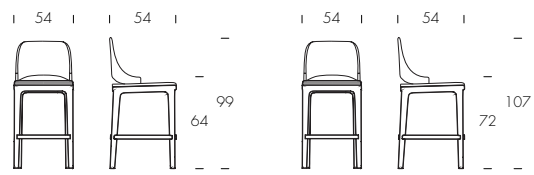

Malva  
base frassino nero/black ash base (25);  
rivestimento ecopelle nabuk ottanio/  
oil-blue nubuck eco-leather covering (SN10).





# malva élite

Andrea Lucatello

La seduta Malva si propone in versione sgabello, unico ed elegante: le linee definite, i braccioli curvati e la base slanciata donano un'identità decisa allo spazio living.  
Nella versione Élite, Malva si arricchisce con l'esclusiva trapuntatura a rombi sullo schienale.

The Malva seat is proposed in a stool version, unique and elegant: the defined lines, the curved armsets and the slender base give a decisive identity to the living space. In the Malva élite version is enriched with the exclusive rhombus pattern on the back.

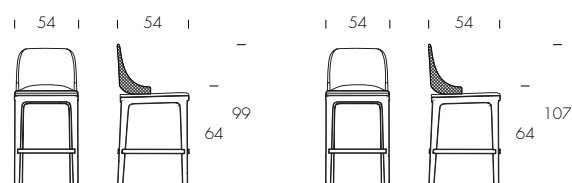

Malva Élite  
base frassino nero/black ash base (25);  
rivestimento pelle blu notte/night blue leather covering (P44).



# manta

Plurimo Design

A completamento della famiglia di sedute Manta, nasce la versione sgabello. Come la sedia, è caratterizzato da una struttura in legno e dal ritorno all'utilizzo del cuoio, per una combinazione perfetta tra funzionalità e design.

To complete the Manta seating family, the stool version is born. Like the chair, it is characterized by a wooden structure and the return to the use of the thick-leather, for a perfect combination of functionality and design.

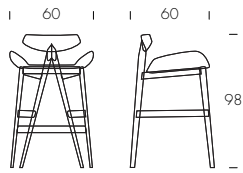

Manta  
base noce Canaletto/Canaletto walnut base (14);  
rivestimento cuoio bianco/white thick leather covering (K01).



# mivida élite

Angelo Tomaiuolo

A completamento della collezione Mivida Élite si aggiunge lo sgabello, disponibile in due carinati di misura con elegante trapuntatura a rombi sullo schienale.

The stool is added to complete the Mivida Élite collection, available in two different sizes with elegant rhombus pattern on the back.

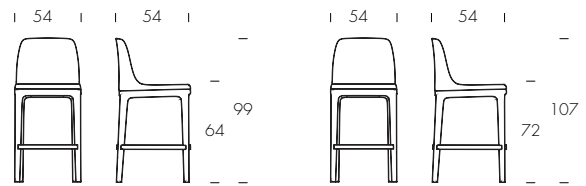

Mivida Élite  
base frassino nero/black ash base (25);  
rivestimento pelle nabuk arancio/orange nubuck leather covering (PN33).







# amarcord

Tonin Casa Creatives

Amarcord è il nuovo divano firmato Tonin Casa che combina le forme iconiche della bellezza italiana e il potere evocativo del design, per creare atmosfere avvolgenti e calde, in un divano ispirato ai ricordi, dal fascino senza tempo.

Amarcord is the new sofa by Tonin Casa that combines the iconic shapes of Italian beauty and the evocative power of design, to create enveloping and warm atmospheres, in a sofa inspired by memories, with a timeless charm.

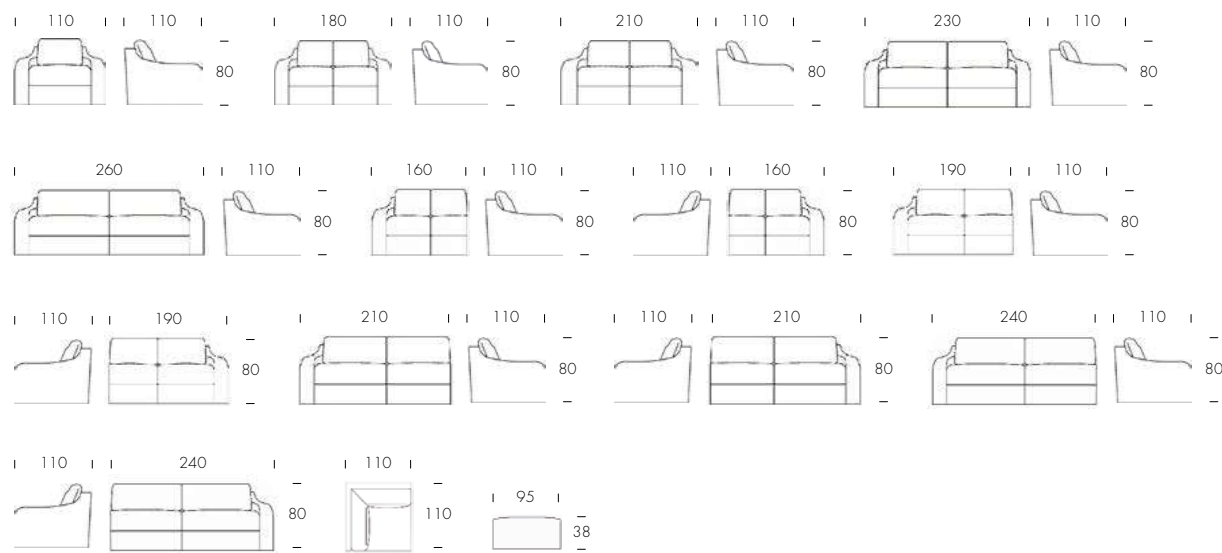



Amarcord  
rivestimento velluto Vega caramello/caramel Vega velvet covering (T23V).





# anvil

Plurimo Design

L'eleganza del design sinuoso si combina alle linee ergonomiche: nasce Anvil, la chaise-longue ideale per un prolungato relax. Rivestimento nelle varie finiture di pelle.

The elegance of the sinuous design is combined with the ergonomic lines: Anvil is born, the ideal chaise-longue for prolonged relaxation. Covering in various leather finishes.

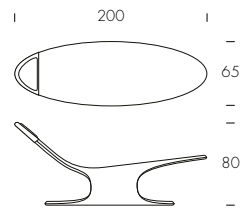

Anvil  
rivestimento pelle giallo/yellow leather covering (P04);  
cordonatura ecopelle testa di moro/  
dark brown eco-leather creasing (S70).



# cleo élite

Tonin Casa Creatives

La collezione Cleo si completa con la poltrona disponibile anche in versione pelle abbinata al tessuto, arricchita nella versione Élite da un'elegante trapuntatura a rombi sullo schienale.  
Confortevole e glamour, riconferma uno stile inconfondibile e un'identità di grande impatto estetico.

The Cleo collection complete itself with the armchair also available in the leather and fabric version, enriched in the Élite version by an elegant thombus pattern on the back.  
Comfortable and glamour, reconfirms an unmistakable style and an identity of great aesthetic impact.

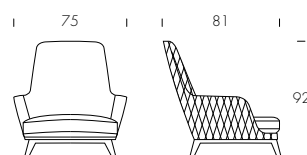



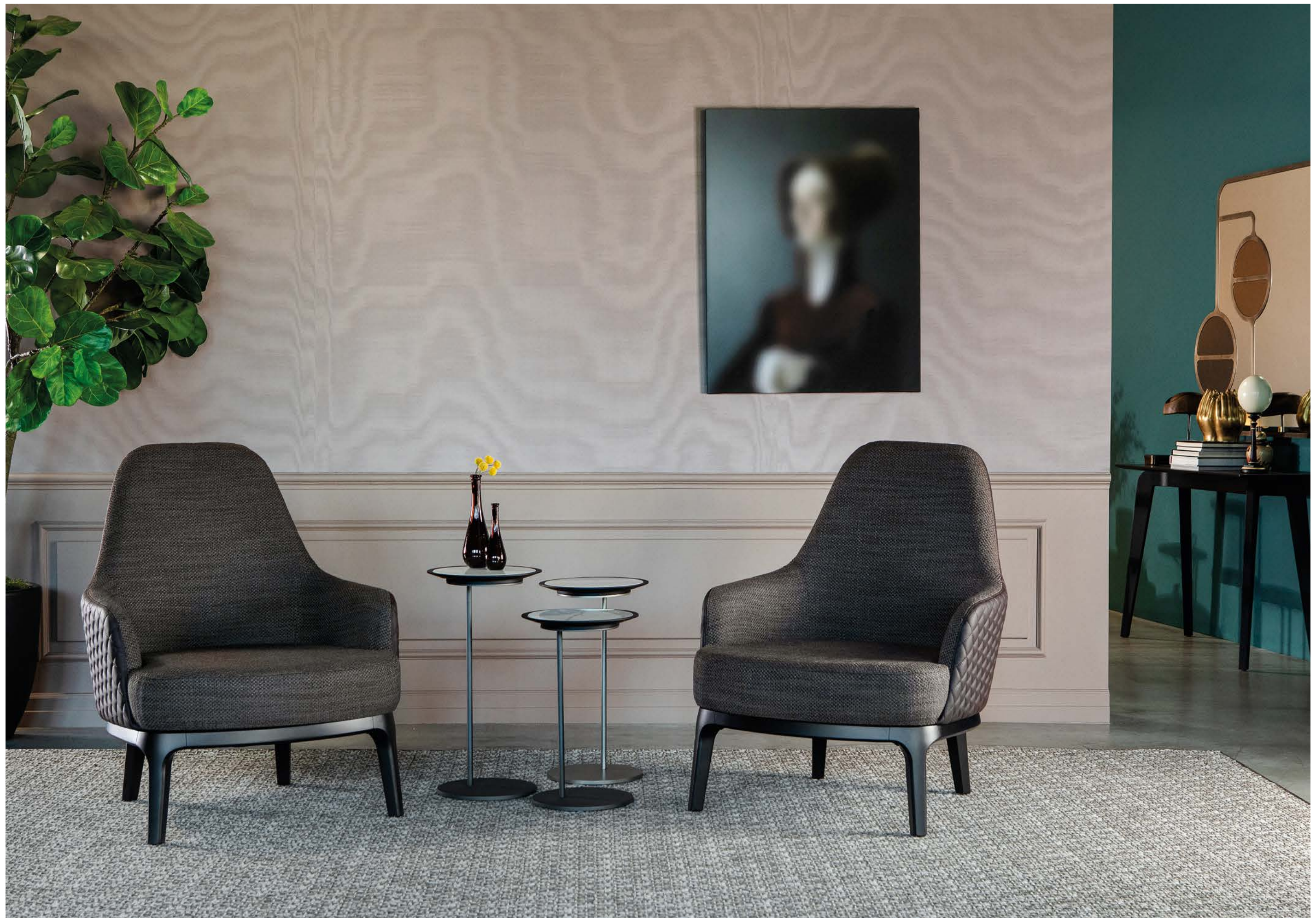

**Cleo**

base frassino nero/black ash base (25);  
rivestimento combinazione Terra d'Oriente: tessuto  
Flora marrone-grigio scuro e pelle testa di moro/  
Terra d'Oriente combination covering: brown-dark  
grey Flora fabric and dark brown leather (02).



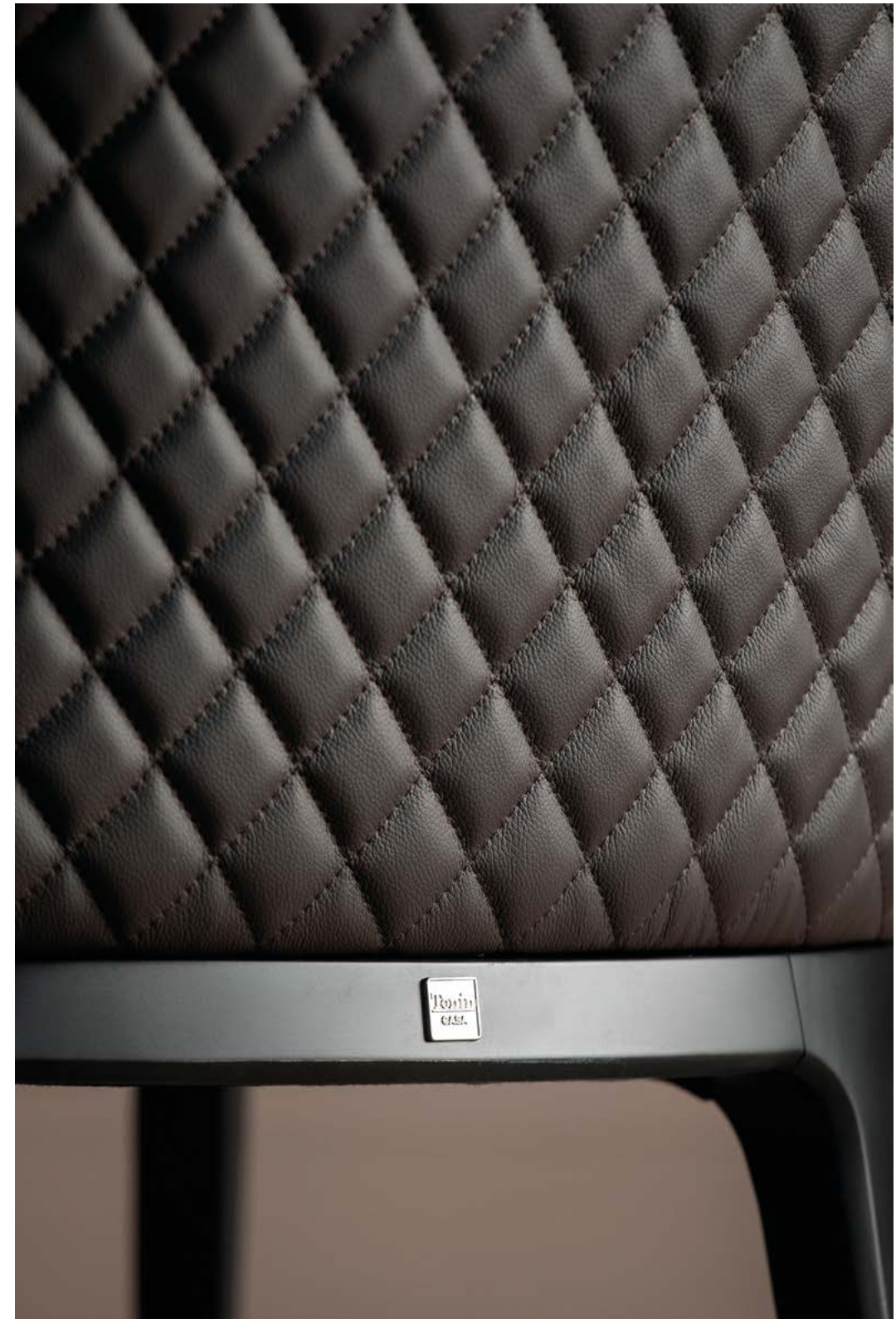



# dolce vita

Tonin Casa Creatives

Eleganza e comfort trovano espressione in questo elemento d'arredo dall'inconfondibile personalità e dall'estrema comodità. Dolce Vita è una poltrona ergonomica dal design invitante, che accompagna il corpo e regala una sensazione di immediata piacevolezza.

Un prodotto artigianale straordinario, che nasce dall'attenzione al dettaglio e dalla visione contemporanea dell'arredamento di Tonin Casa.

Elegance and comfort find expression in this piece of furniture with an unmistakable personality and extreme comfort. Dolce Vita is an ergonomic armchair with an inviting design, which accompanies the body and gives a sensation of immediate pleasure.

An extraordinary handcrafted product, which comes from the attention to detail and the contemporary vision of Tonin Casa's furnishings.

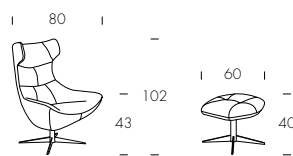

Dolcevita  
rivestimento combinazione Acquamarina: tessuto Flora marrone-ottanio e pelle ottanio/  
Acquamarina combination covering: brown-oil blue Flora fabric and oil blue leather (06).







# doppio sogno

Tonin Casa Creatives

Doppio Sogno, una maxi poltrona dal design morbido e avvolgente, una seduta ideale per lasciarsi avvolgere dal comfort più generoso, un nido per dedicarsi a sé, al relax, al riposo e alla lettura.

Girevole, realizzata con fusto di pioppo, legni diversi e multistrato di faggio. La seduta e lo schienale, secondo le tecnologie più avanzate, sono in poliuretano espanso. Doppio Sogno è disponibile in un'ampia gamma di finiture: pelle, tessuto, velluto, nubuk.

Doppio Sogno, a maxi armchair with a soft and enveloping design, an ideal seat to let oneself be enveloped by the most generous comfort, a nest to dedicate to oneself, to relax, rest and read.

Swivel, made with poplar frame, different woods and beech plywood. The seat and back, according to the most advanced technologies, are in polyurethane foam. Doppio Sogno is available in a wide range of finishes: leather, fabric, velvet, nubuck.

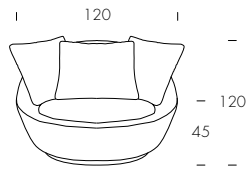



Doppio Sogno

rivestimento combinazione Terra Bruciata: tessuto Flora grigio scuro-bianco e pelle cognac/  
Terra Bruciata combination covering: dark grey-white Flora fabric and cognac leather (03);  
rivestimento velluto Vega blu profondo/Vega velvet deep blue covering (T10V).





# mama

Angelo Tomaiuolo

Dalla ripresa stilistica delle poltrone Mama, firmate Tonin Casa, nasce questo pouf: un abbraccio tra tessuti pregiati e lavorazioni in pelle per un comfort totale.

From the stylistic revival of the Mama armchairs, designed by Tonin Casa, this pouf is born: an hug between fine fabrics and leather work for a total comfort.

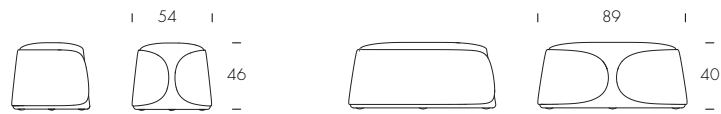

Mama  
rivestimento combinazione Grigio Intenso: tessuto Flora marrone-beige e pelle grigio/  
Grigio Intenso combination covering: brown-beige Flora fabric and grey leather (01).



# moove

Tonin Casa Creatives

Estetica decisa, volumi geometrici e ben definiti sono ciò che caratterizza il divano , che evoca nel nome le parti mobili di cui è composto: la seduta infatti può essere spostata in avanti, in una posizione di riposo e relax ulteriore, offrendo comfort e comodità superiori.

Strong aesthetics, geometric and well-defined volumes are what characterize the Moove sofa, which evokes in the name the moving parts of which it is composed: the seat can in fact be moved forward, in a position of further rest and relaxation, offering comfort and superior coziness.

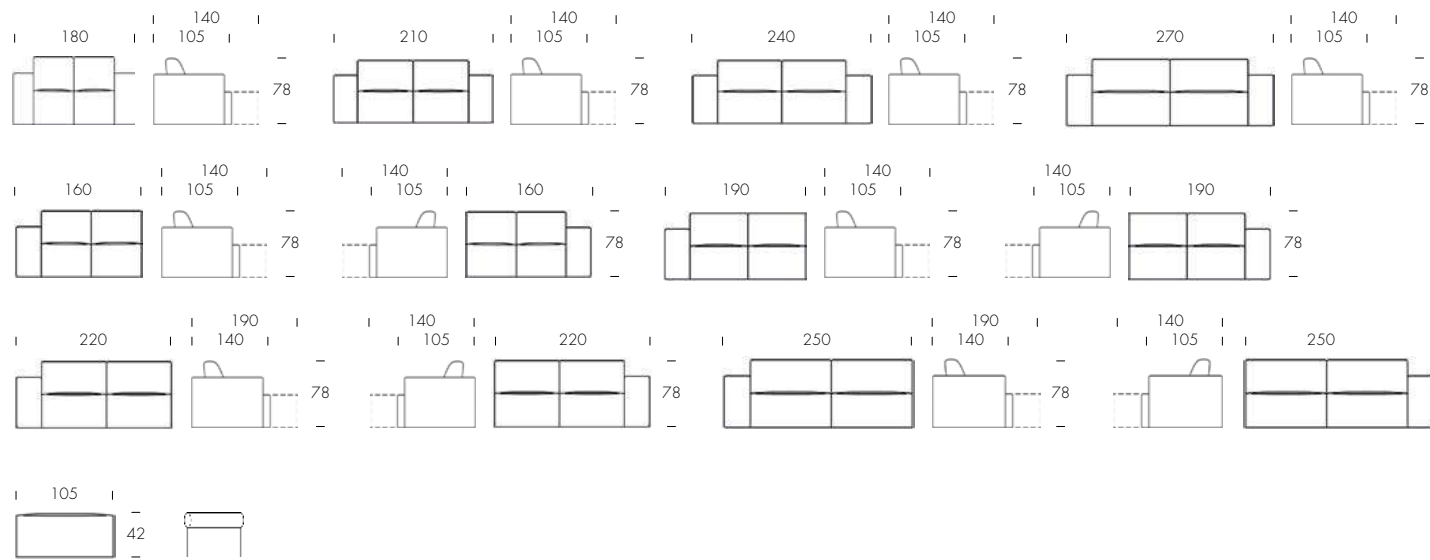



Moove  
rivestimento pelle grigio/  
grey leather covering (P73).





# metropolis

Tonin Casa Creatives

Con la sua struttura dalle linee essenziali e aperte, Metropolis è un'elegante fusione di elementi dal design contemporaneo, ispirato al massimo comfort. La seduta profonda, i morbidi cuscini e l'ampia penisola invitano al relax, in un effetto d'insieme di grande leggerezza dato dalla sua struttura sospesa.

With its structure with essential and open lines, Metropolis is an elegant fusion of elements with a contemporary design, inspired by maximum comfort. The deep seat, the soft cushions and the large peninsula invite you to relax, in an overall effect of great lightness given by its suspended structure.

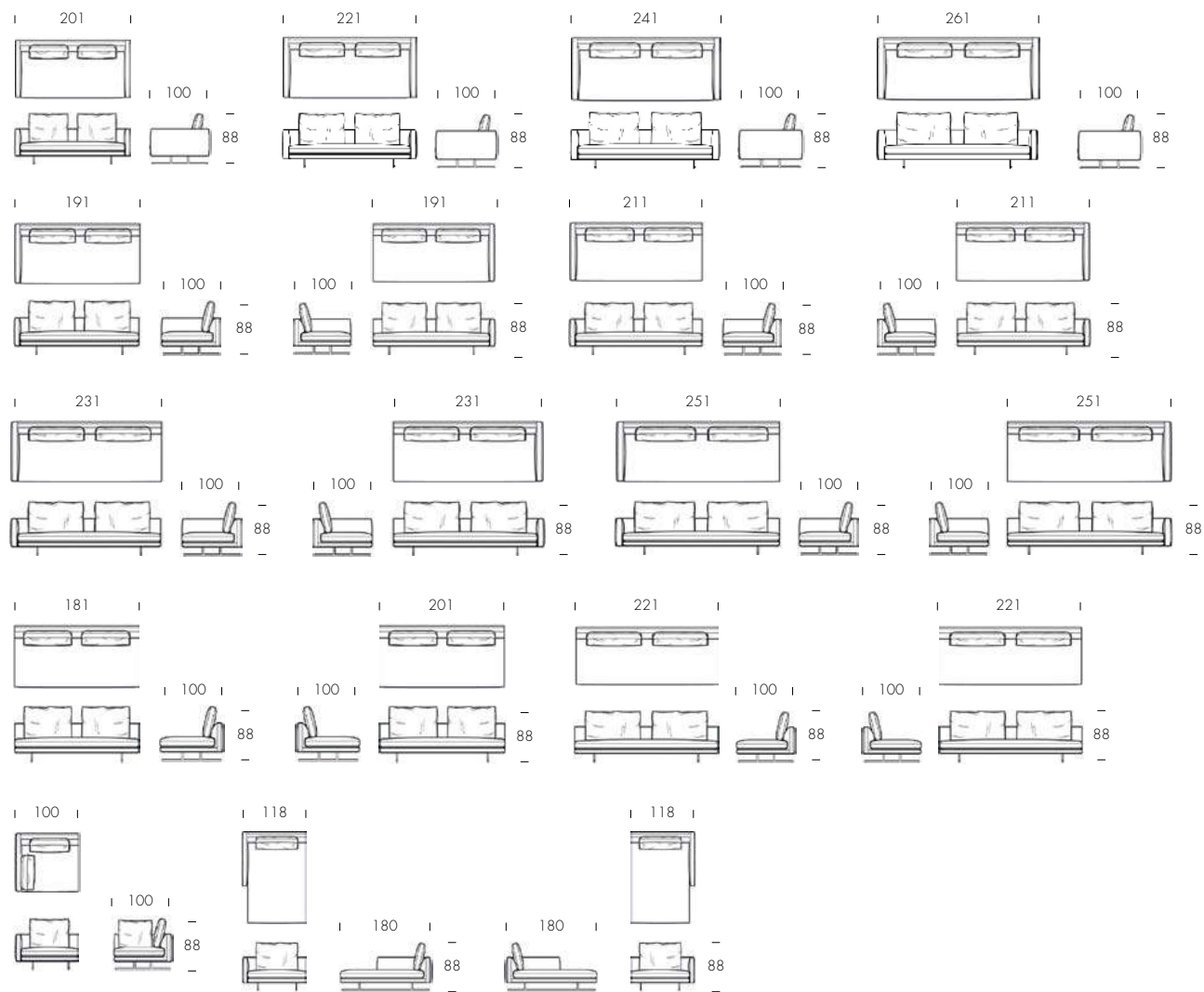



**Metropolis**  
rivestimento tessuto Flora grigio chiaro-beige/  
light grey-beige Flora fabric covering (TF04).





# sebastian

Tonin Casa Creatives

Sebastian, un accogliente invito al relax, che arreda con personalità e grande eleganza: il sistema di seduta su ampie superfici imbottite e penisola laterale si unisce alle forme morbide e agli schienali inclinati, con movimento poggiatesta, per un effetto di comfort unico.

Sebastian, a welcoming invitation to relax, which furnishes with personality and great elegance: the seating system on large padded surfaces and lateral peninsula joins the soft shapes and inclined backrests, with headrest movement, for a unique comfort effect.

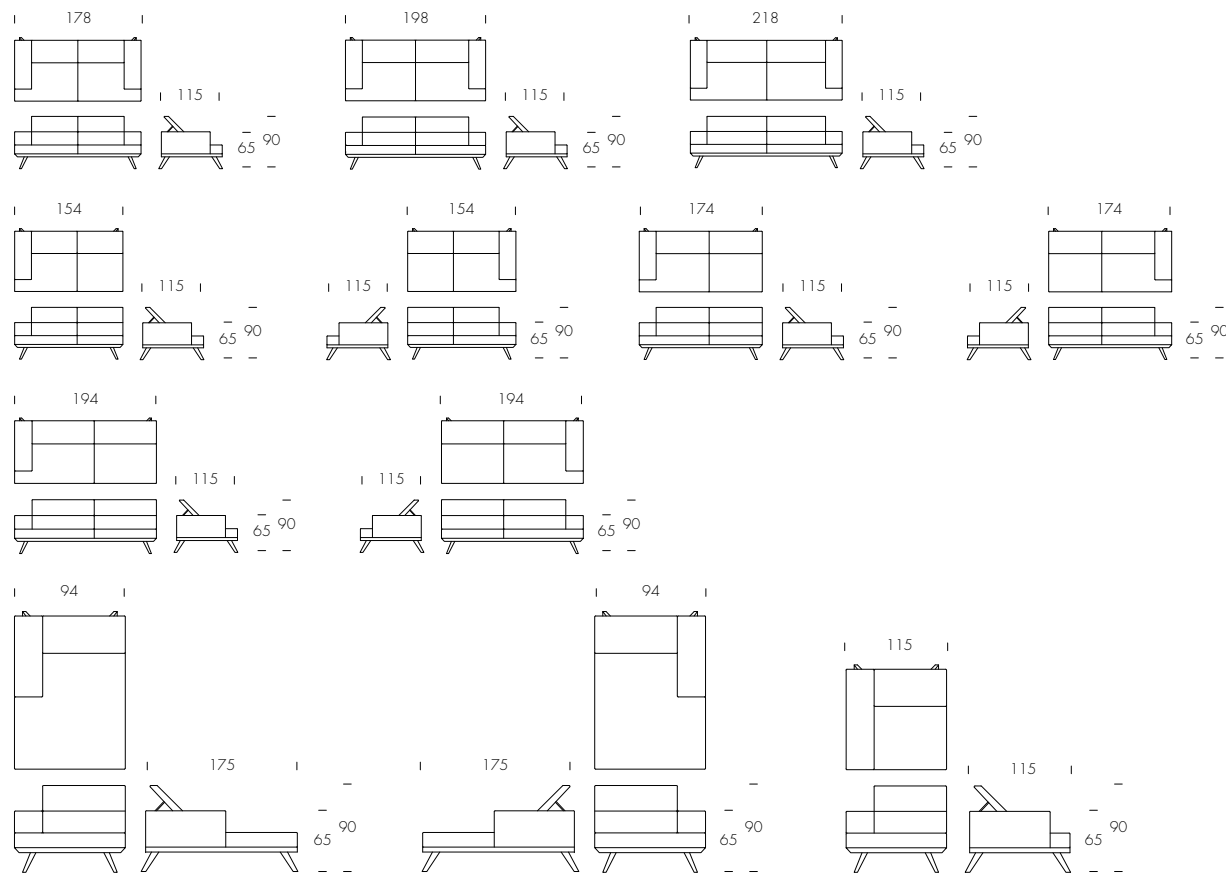





Sebastian  
rivestimento pelle nabuk blu notte/  
night blue nubuck leather covering (PN44).







# aira

Cristian Dal Bianco

La parola Aira deriva dall'arabo e significa "splendente", aggettivo che ben si addice alla raffinata eleganza di questa madia che, con ante in gres e dotata di led interno, è in grado di far brillare qualsiasi spazio abitativo. L'inedita apertura laterale delle due vetrine ai fianchi della madia conferisce un'identità precisa al suo esclusivo design.

The word Aira derives from Arabic and means "shining", an adjective that is well suited to the refined elegance of this sideboard which, made with porcelain stoneware doors and equipped with internal leds, is able to make shine any living space. The unpublished lateral opening of the two windows placed on the sides of the sideboard gives a precise identity to its exclusive design.

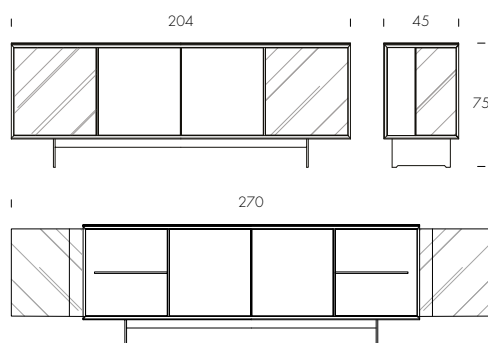

Aira  
ante vetro fumè trasparente/transparent fumè glass doors (V85);  
struttura gres Crème opaco/matt Crème porcelain structure (V91P).







**Aira**  
ante vetro fumè trasparente/  
transparent fumè glass doors (V85);  
struttura gres Emperador/  
Emperador porcelain structure (V83P).



# alcione

Luca Roccadadria

La purezza del design incontra la preziosa lavorazione artigianale nella raffinata madia Alcione, caratterizzata dall'elegante combinazione di porcellana e vetro sulle ante. La manifattura esclusiva e la fusione dei diversi materiali crea una continua variazione di luminosità, dall'estetica potente.

The purity of the design meets the precious craftsmanship in the refined Alcione sideboard, characterized by the elegant combination of porcelain and glass on the doors. The exclusive manufacturing and the fusion of different materials creates a continuous variation of brightness, with a powerful aesthetic.

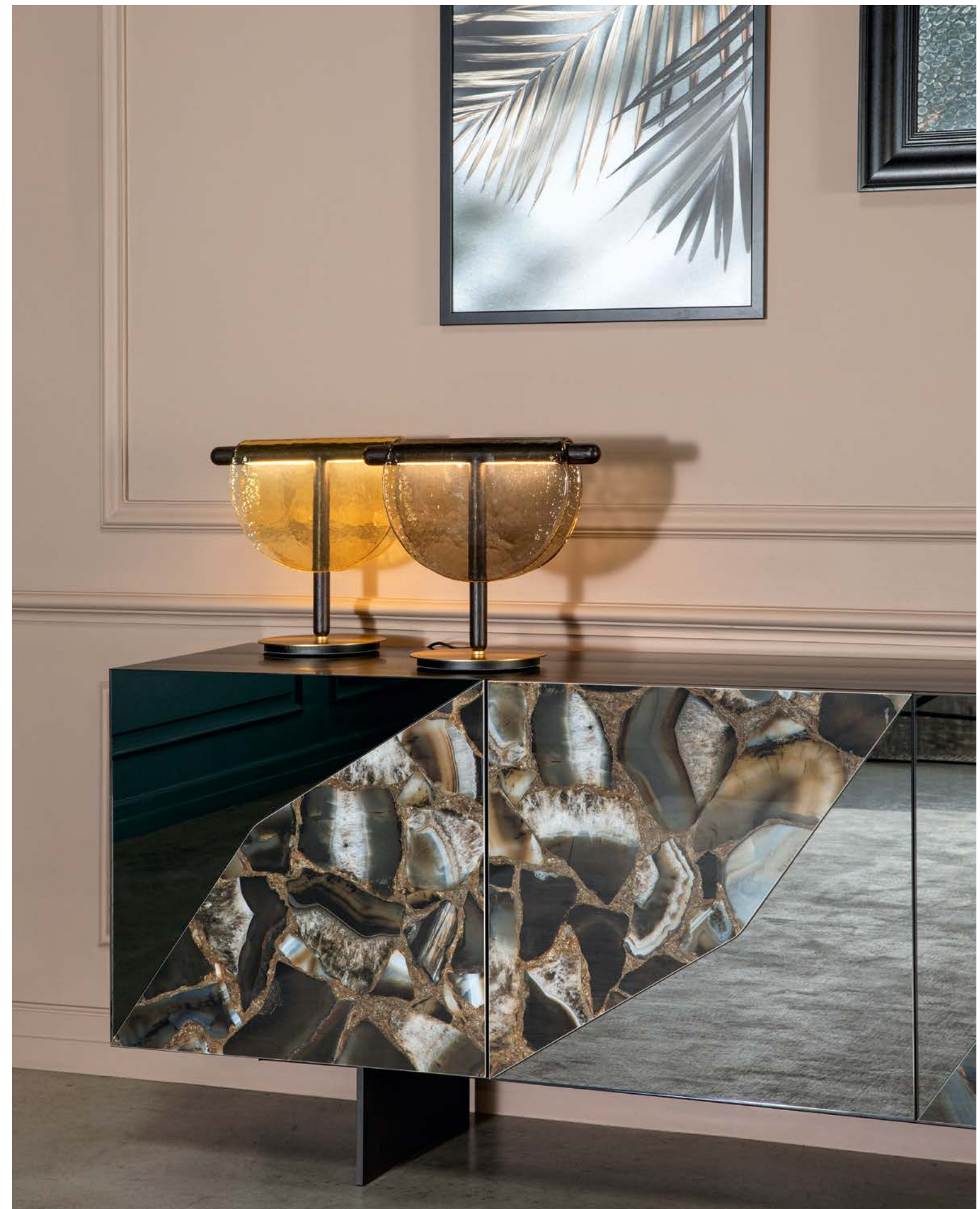
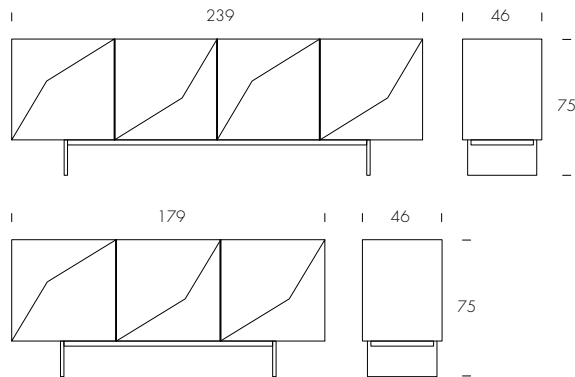



**Alcione**  
ante gres Agata Black e specchio fumè/  
Agata Black porcelain and fumè mirror doors (V95P, VS87).





Alcione  
ante gres Terra Liquida e specchio bronzo/  
Terra Liquida porcelain and  
bronzed mirror doors (V92P, V184).

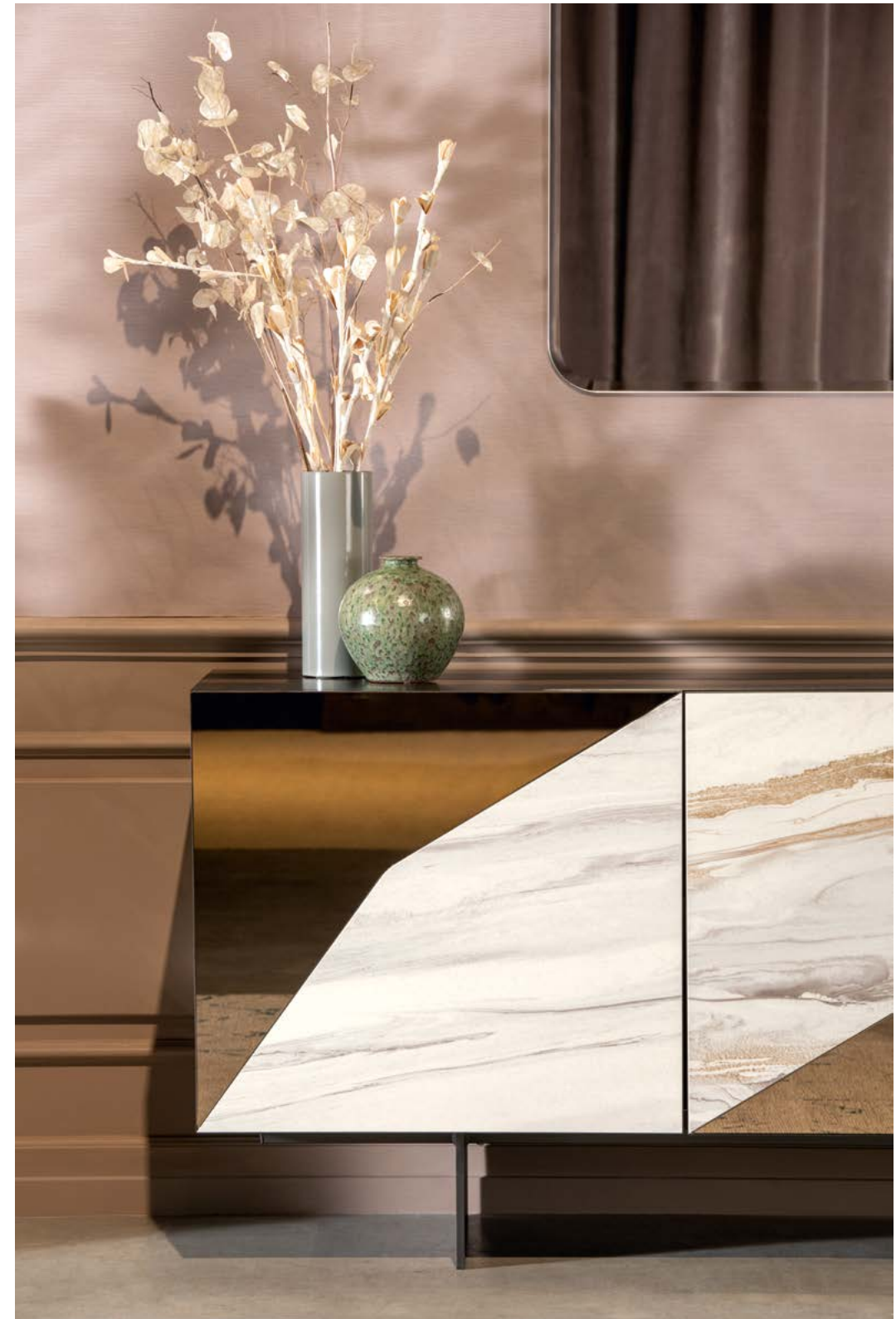



# barcode

Mottin M. | Barbieri E.

Barcode: dal suo nome deriva un'originale madia che accosta un insieme di elementi lineari a contrasto, tramite un gioco di specchio argento e laccatura nera o nella variante bianca con laccatura nera.

Barcode: from its name derives an original sideboard that combines a set of linear elements with a contrast, through a play of silver mirror and black lacquering or in the white variant with black lacquering.

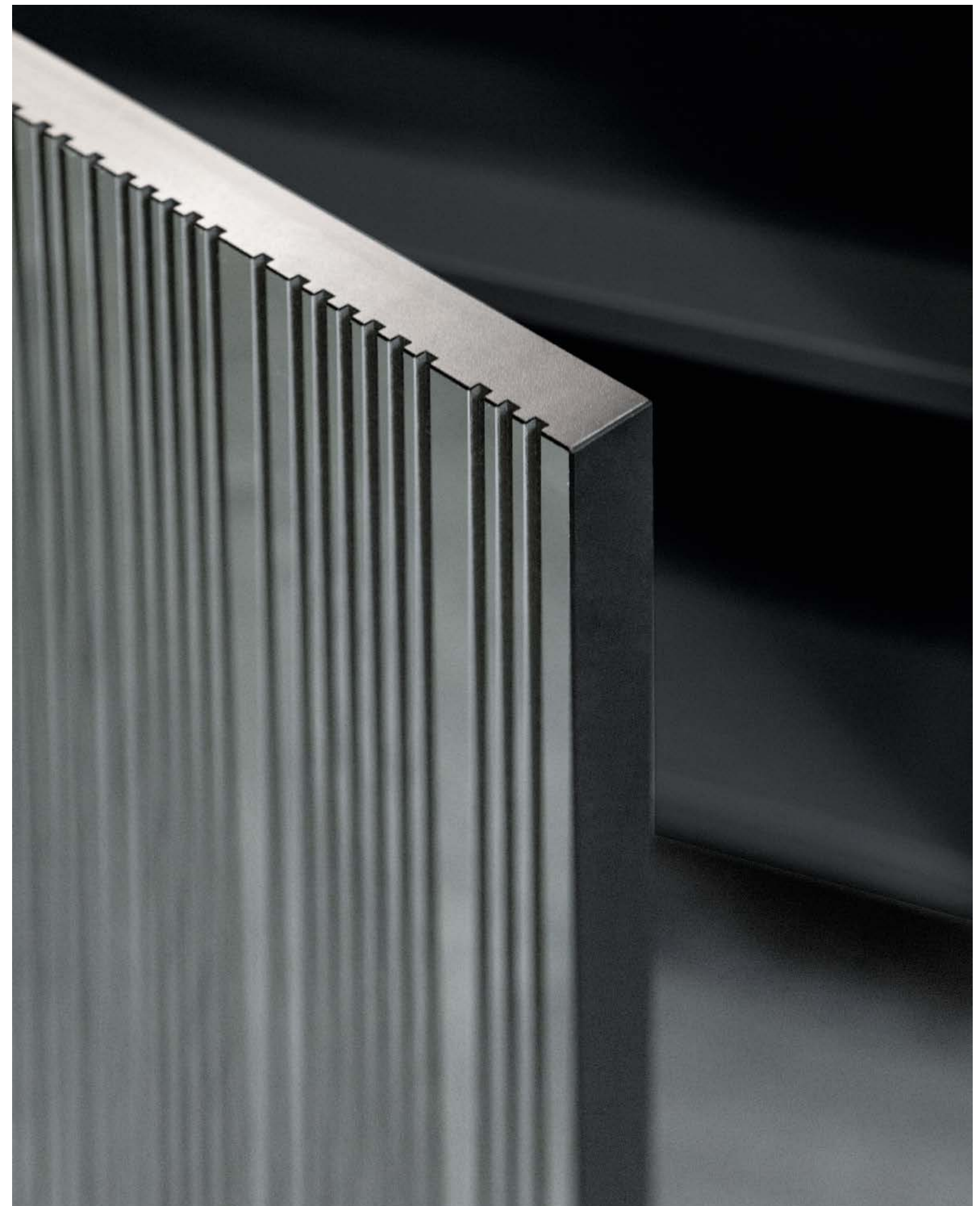
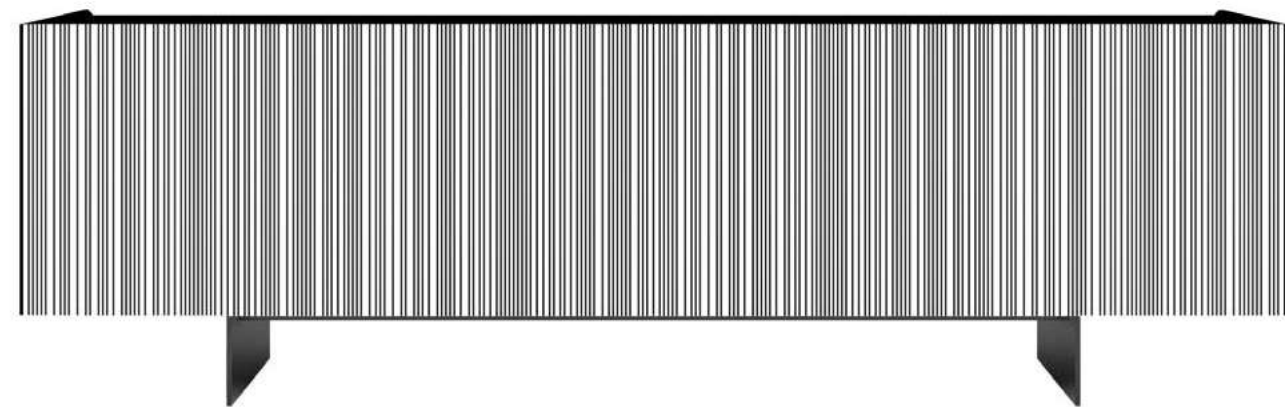
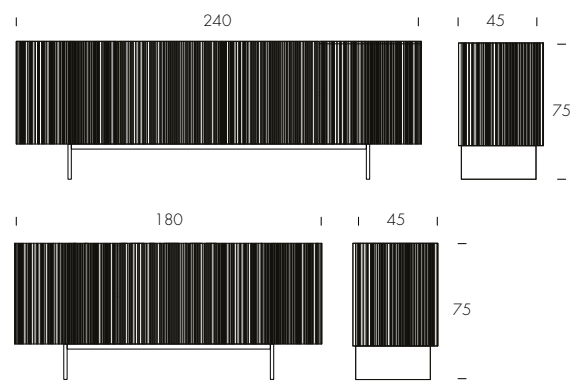



Barcode  
ante nero opaco e specchio argento/  
matt black and silver mirror doors (02).





# cannetè

LM Design

La madia Cannetè si inserisce armoniosamente in ogni tipo di ambiente, con la sua truttura in laccato nero, ante in specchio fumè o bronzo e cornice superiore in vetro cannettato dalla particolare lavorazione rigata che ne impreziosisce la purezza della forma.

The Cannetè sideboard fits harmoniously into any type of environment, with its black lacquered structure, fumè or bronze mirror doors and upper frame in ribbed glass with a particular striped processing that enhances the purity of the shape.

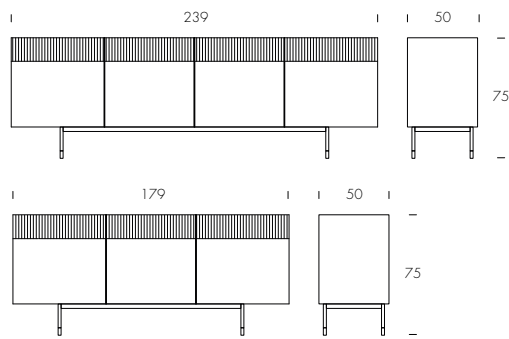

Cannetè  
ante specchio bronzato/bronzed mirror doors (V184).





Cannetè  
ante specchio fumè/fumè mirror doors (VS87).





# canova

LM Design

Essenzialità formale abbinata a materiali pregiati e a finiture preziose ed esclusive: la madia Canova esalta l'artigianato Made in Italy in un equilibrio perfetto tra eleganza e design.

Un elemento iconico, con struttura portante in legno laccato nero e base in metallo verniciato, le ante in vetro tono bronzo o fumè sono impreziosite con inserto in gres porcellanato dalle venature calde che accarezzano la superficie della madia, sollecitano al tatto e sprigionano luce e energia. Disponibile in varie finiture

Formal essentiality combined with precious materials and precious and exclusive finishes: the Canova sideboard enhances Made in Italy craftsmanship in a perfect balance between elegance and design.

An iconic element, with a supporting structure in black lacquered wood and a painted metal base, the bronze or smoked glass doors are embellished with a porcelain insert with warm veins that caress the surface of the sideboard, stimulate the touch and release light and energy. Available in various finishes

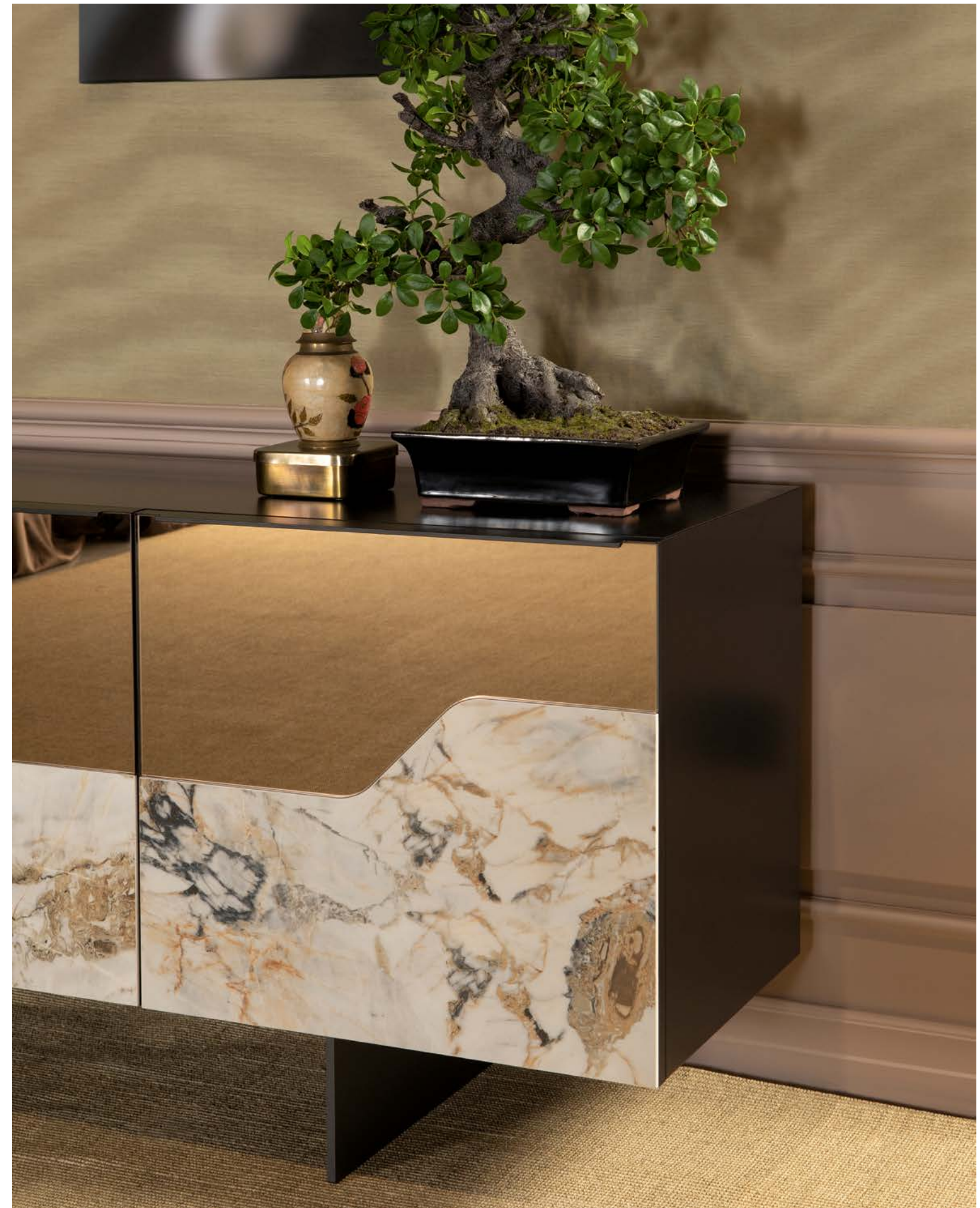
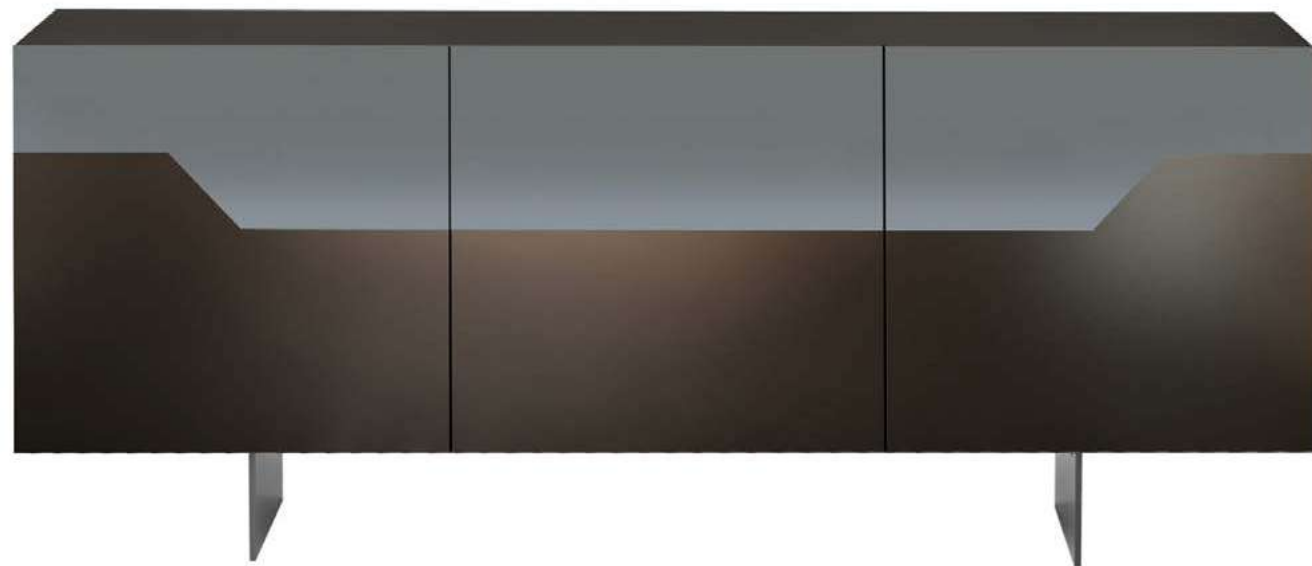
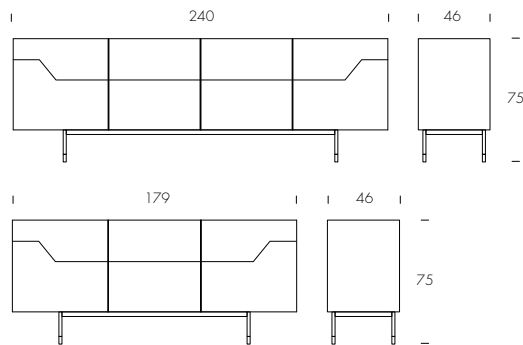



Canova  
ante gres Symphonie e specchio bronzo/  
Symphonie porcelain and bronzed mirror doors (V89P, V184).





Canova  
ante specchio fumè + satinato/fumè + satin mirror doors (VS87).





# debussy

Tonin Casa Creatives

Eleganza al contempo essenziale e sofisticata, ispirata al grande compositore e pianista francese: la struttura della madia Debussy è composta da tre o quattro ante in vetro nero, rese particolari dalle maniglie caratterizzate da finiture in vetro martellato argentato, dettagli funzionali che diventano elementi fortemente caratterizzanti, quasi a richiamare i tasti di un pianoforte. Una madia preziosa, dalle linee senza tempo, come la musica immortale di Debussy e le sue atmosfere sognanti.

Elegance at the same time essential and sophisticated, inspired by the great French composer and pianist: the structure of the Debussy sideboard is composed of three or four doors in black glass, made special by the handles characterized by finishes in silver hammered glass, functional details that become strongly characterizing elements, as if to recall the keys of a piano. A precious sideboard, with timeless lines, like Debussy's immortal music and his dreamy atmospheres.

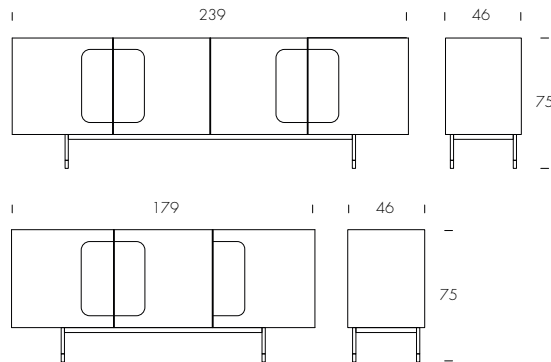

Debussy  
ante specchio nero/black mirror doors;  
maniglie vetro martellato nero/black hammered glass handles.





Debussy  
ante specchio nero/black mirror doors;  
maniglie vetro tessuto oro/gold fabric glass handles.





# diva

Luca Roccadadria

La madia Diva, dal design lineare che caratterizza la sua valenza estetica di grande impatto è realizzata con una combinazione di elementi specchianti nelle varianti argento, bronzo e fumè. Le linee creano movimento con un suggestivo gioco minimale, caldo e accogliente, per chi ama i dettagli e la perfezione.

The Diva sideboard, with a linear design that characterizes its high impact aesthetic value, is made with a combination of mirroring elements in the silver, bronze and fumè variants. The lines create movement with a suggestive minimal game, warm and welcoming, for those who love details.

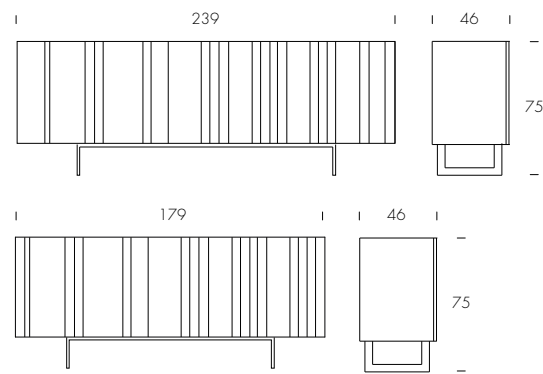

Diva  
ante specchio argento, bronzo e fumè/  
silver, bronze and fumè mirror doors.





# dot

M. Mottin | E. Barbieri

Dot è una madia minimal chic dalla forma leggera e dal carattere deciso, design elegante e dettagli preziosi: un cerchio perfetto che funge da maniglia in legno o in gres porcellanato esalta l'estetica delle ante in cristallo trasparente o fumè.

Dot is a minimal chic sideboard with a light shape and a strong character, elegant design and precious details: a perfect circle that acts as a wooden or porcelain handle enhances the aesthetics of the transparent or fumè glass doors.

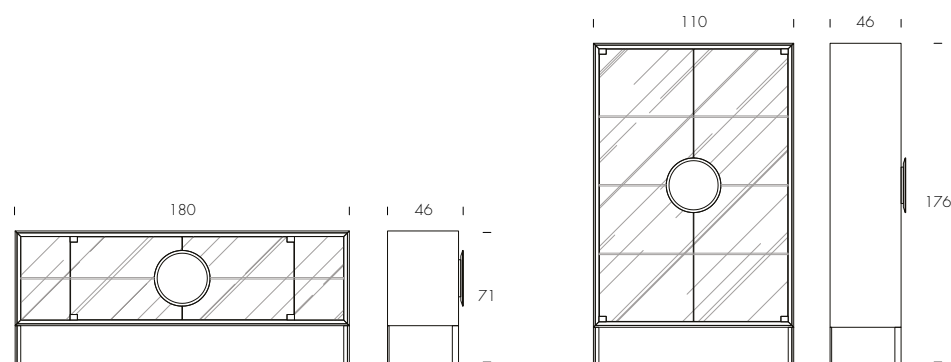

Dot  
ante vetro fumè trasparente / transparent fumè glass doors (V85);  
maniglia frassino nero / black ash handle (25).

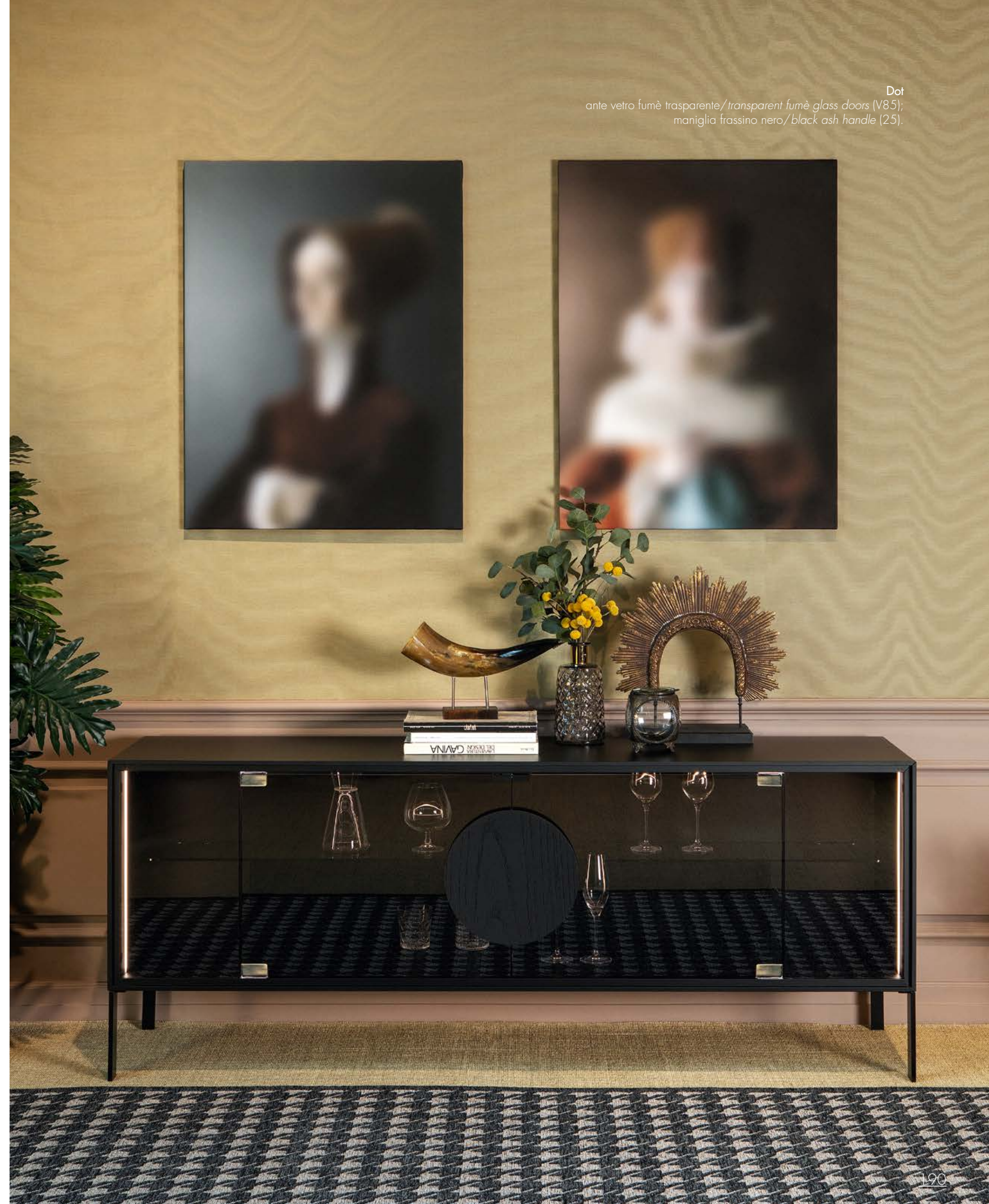



Dot  
ante vetro extrachiaro trasparente / transparent extra-clear glass doors (V100);  
maniglia frassino nero+gres onice ambra / black ash+onyx amber porcelain handle (25+V55P).





# extro

Studio Archirivolto

Extro, una madia rivoluzionaria che rompe gli schemi: le ante ricoperte in velluto, dal tocco dandy, donano alla sua linea stondata una sensazione morbida e sinuosa. Il top è in porcellanato, così da renderla come un diamante al centro dell'attenzione e protagonista di ogni living più raffinato.

Extro, a revolutionary sideboard that breaks the mold: the velvet-covered doors, with a dandy touch, give its rounded line a soft and sinuous feeling. The top in porcelain, is like a diamond in the center of attention and protagonist of every refined living room.

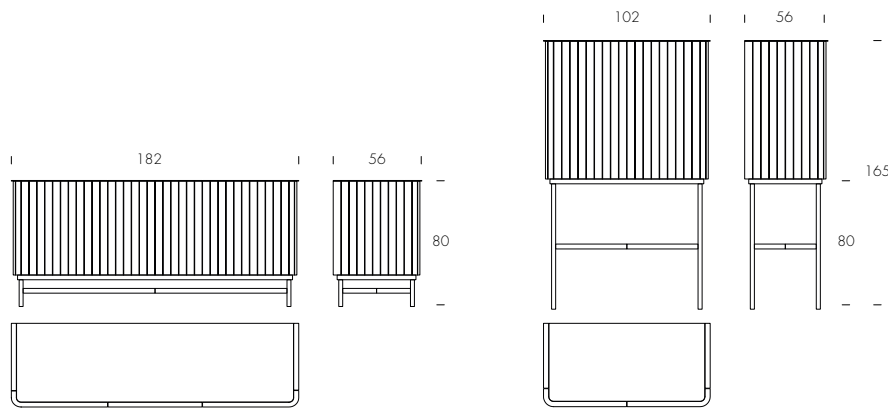





**Extro**  
ante velluto Vega blu profondo/  
deep blue Vega velvet doors (T10V);  
top gres Macchiavecchia lucido/  
shiny Macchiavecchia porcelain top (V87P).









# gaudì

M. Mottin | E. Barbieri

Materiali pregiati e rivestimento esclusivo: la madia Gaudì coniuga unicità, bellezza, attenzione al dettaglio e maestria artigianale, per un effetto estetico ispirato alle opere dell'architetto spagnolo Antoni Gaudì. Le ante di questa preziosa madia sono ricoperte da una fluida applicazione di macro mosaici in ceramica dalle sfumature splendenti, realizzati e applicati a mano dai maestri artigiani di BottegaNove. Un rivestimento che dona una sensazione di movimento e crea una superficie suggestiva, grazie agli elementi che si combinano tra loro in gradazioni cromatiche sorprendenti: 107 petali a mosaico in ceramica bianca, madreperla e oro zecchino lucido.

Precious materials and exclusive upholstery: the Gaudì sideboard combines uniqueness, beauty, attention to detail and craftsmanship, for an aesthetic effect inspired by the works of the Spanish architect Antoni Gaudì. The doors of this precious sideboard are covered with a fluid application of ceramic macro mosaics with shining shades, made and applied by hand by BottegaNove's master craftsmen. A coating that gives a sensation of movement and creates an evocative surface, thanks to the elements that combine with each other in surprising chromatic shades: 107 mosaic petals in white ceramic, mother-of-pearl and shiny pure gold.

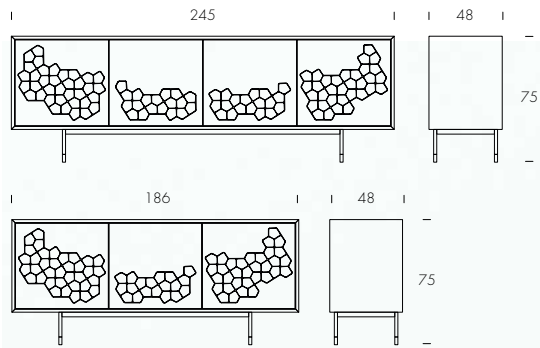





Gaudi  
struttura frassino nero/black ash structure (25).



# hopper

Luca Roccadadria

La dimensione onirica e sospesa di questa madia richiama le atmosfere del pittore statunitense Edward Hopper. Nelle ante in cristallo bombato, specchiato bronzo o fumè, spiccano volumi che richiamano un universo quasi metafisico ed esaltano l'estetica potente di questa madia in una combinazione preziosa di luci e ombre, che cattura lo sguardo.

The dreamlike and suspended dimension of this sideboard recalls the atmosphere of the American painter Edward Hopper. In the rounded, bronze or fumè mirrored glass doors, volumes that recall an almost metaphysical universe stand out and enhance the powerful aesthetics of this sideboard in a precious combination of light and shadow, which captures the eye.

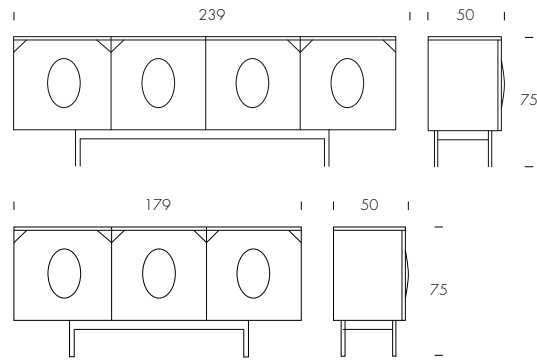

Hopper  
ante specchio bronzato/bronzed mirror doors (V184).





Hopper  
ante specchio fumè/  
fumè mirror doors (VS87).





# plume

M. Mottin | E. Barbieri

Sorprendente e unica, la madia che utilizza la collezione Plumage disegnata da Cristina Celestino per BottegaNove, coniuga bellezza e attenzione al dettaglio e all'artigianalità. Le ante della madia sono ricoperte da una leggera cascata di piume sovrapposte l'una all'altra, dalle sfumature splendenti in ceramica smaltata realizzata dai maestri artigiani di BottegaNove. Plumage è una collezione di mosaici in ceramica disegnata da Cristina Celestino per BottegaNove che trova una sorprendente applicazione in questa madia.

Surprising and unique, the sideboard that uses the Plumage collection designed by Cristina Celestino for BottegaNove, combines beauty and attention to detail and craftsmanship. The doors of the sideboard are covered with a slight cascade of feathers superimposed on each other, with shining shades of glazed ceramic made by master craftsmen from BottegaNove. Plumage is a collection of ceramic mosaics designed by Cristina Celestino for BottegaNove which finds a surprising application in this sideboard.

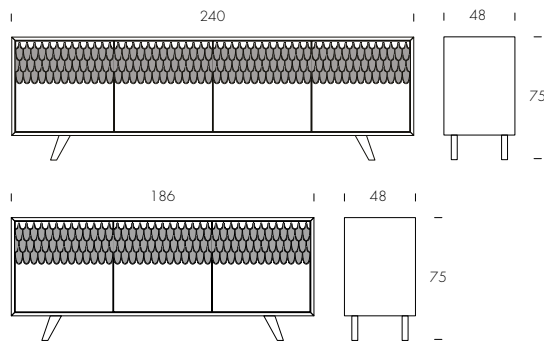



Plume  
struttura frassino nero/black ash structure (2,5).









# coated

Tonin Casa Creatives

La laccatura spazzolata effetto brushed caratterizza il porta-tv Coated, che fonde nelle sue linee uno stile contemporaneo con una finitura ricercata.

The brushed lacquer effect characterizes the Coated tv-stand, which blends in its lines a contemporary style with a refined finish.

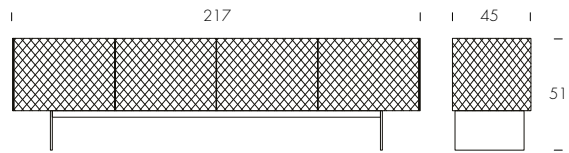

Coated  
struttura brushed bronzo/brushed bronze structure (SP83).





# matisse

Tonin Casa Creatives

La particolarità del porta-tv Matisse è data dalle finiture in laccato e decoro incassato dall'effetto traslucido.  
Un pezzo monovolumetrico dall'indiscutibile personalità.

The particularity of Matisse tv-stand is given by the lacquered finishes and recessed decoration with a translucent effect.  
A monovolumetric piece with indisputable personality.

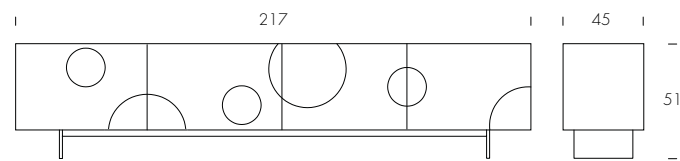

Matisse  
struttura bronzo pietra/stone bronze structure (83).



# opera

M. Mottin | E. Barbieri

A completamento della collezione Opera, nasce questo nuovo porta-tv o madia bassa. Il laccato delle ante e l'abbinamento della scocca in legno lo rendono un complemento d'arredo versatile dal fascino senza tempo.

To complete the Opera collection, this new TV-stand or low sideboard is born. The lacquer of the doors and the combination of the wooden shell make it a versatile piece of furniture with a timeless charm.

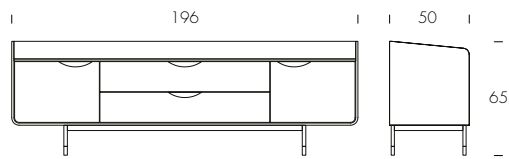

Opera  
struttura bianco opaco/matt white structure (01).





# teo

Tonin Casa Creatives

Le linee definite e il design plurimaterico del porta-tv Teo invitano a trovare nuovi spazi grazie al ripiano centrale e alle due ante laterali con finitura porcellanato o in essenza.

The defined lines and the multimaterial design of the Teo tv-stand invite you to find new spaces thanks to the central shelf and the two side doors with porcelain or wood finish.

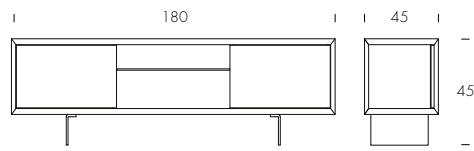

Teo  
struttura antracite/anthracite structure (64);  
ante gres Emperador/Emperador porcelain doors (V83P).







# archè

G. Codato | L. Trevisiol

Una libreria esclusiva dalle linee leggere e sinuose e dal design attento ad ogni esigenza, con ripiani in cristallo e struttura in legno massello, composta da una molteplicità di materiali: legno, metallo, gres, cristallo e uno specchio tondo con finiture bronzo o argento.

An exclusive library with light and sinuous lines and with a design attentive to every need, with crystal shelves and solid wood structure, composed of a multiplicity of materials: wood, metal, stoneware, crystal and a round mirror with bronze or silver finishes.

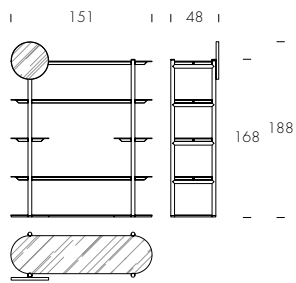

Archè  
ripianti vetro fumè trasparente / transparent fumè shelves (V85);  
base gres Portoro / Portoro porcelain base (V85P);  
struttura frassino nero / black ash structure (25).









# honeybook

Angelo Tomaiuolo

Una libreria dall'identità precisa che riprende l'elemento alveolare della madia Honey. Honeybook è una libreria monomaterica, in acciaio verniciato, originale, funzionale, pratica e adatta a qualsiasi ambiente e gusto. Disponibile in varie misure e interpretabile anche come divisorio di più ambienti.

A library with a precise identity that incorporates the honeycomb element of the honey sideboard. Honeybook is a single-material bookcase in painted steel, original, functional, practical and suitable for any space and taste. Available in various sizes, and can also be interpreted as a room divider.

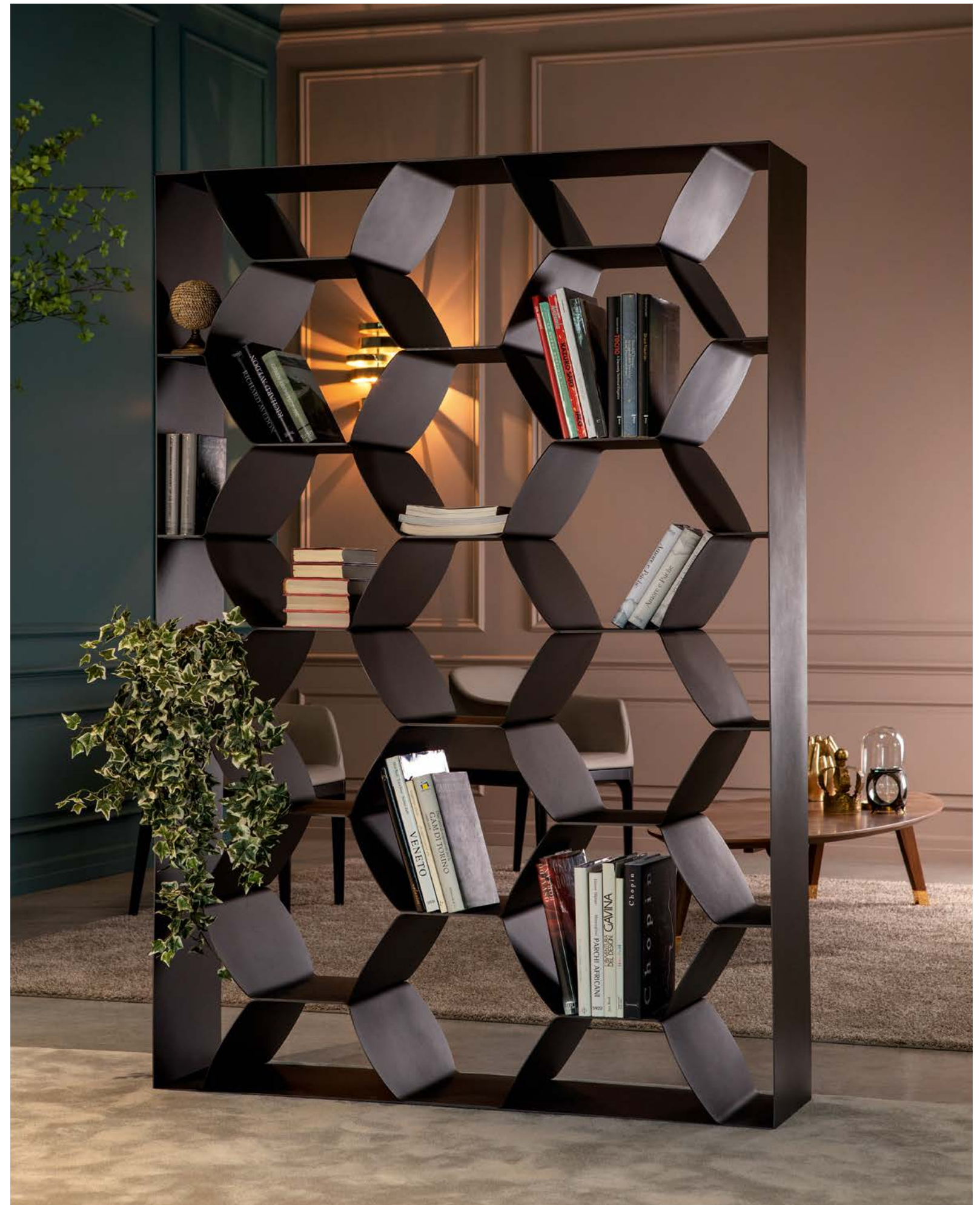
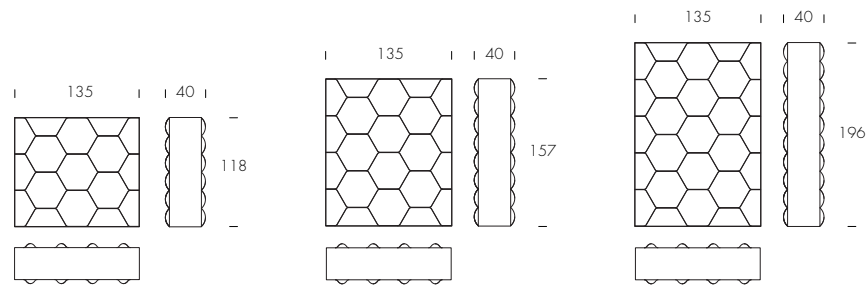



Honeybook  
struttura grigio carbone e bianco opaco/  
carbon grey and matt white structure (01, 10).





# kaspar

Angelo Tomaiuolo

Kaspar, oltre a essere una libreria, diventa anche una vera e propria parete divisoria, dalla struttura in legno curvato, impreziosita da cesti in cuoio o paglia di Vienna. Disponibile in varie finiture.

Kaspar, in addition to being a bookcase, also becomes a real dividing wall, with a structure in curved wood, embellished with baskets in leather or Vienna straw. Available in multiple finishes.

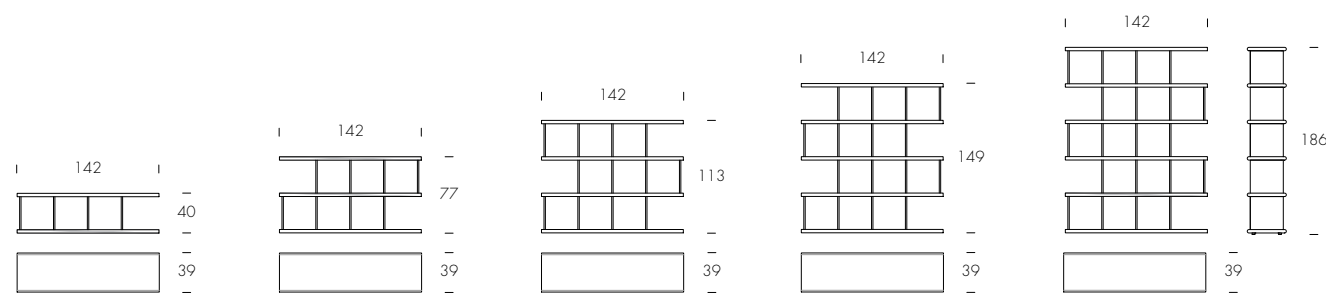



Kaspar  
struttura antracite o bianca/anthracite or white structure (64)(01);  
ripiani noce Canaletto/Canaletto walnut shelves (14);  
cesti paglia di Vienna, cuoio cognac e arancio Siracusa/  
Vienna straw, cognac and Siracusa orange thick leather (PGL1, K59, K33).





# master

Plurimo Design

La libreria Master, dal design funzionale e allo stesso tempo di grande effetto e valore estetico, è caratterizzata dalla peculiarità della sua forma che deriva dall'incontro di legni curvati, lavorati dall'abilità dei nostri maestri artigiani.

The Master bookcase, with a functional design and at the same time of great effect and aesthetic value, is characterized by the peculiarity of its shape that derives from the meeting of curved woods, worked by the skill of our master craftsmen.

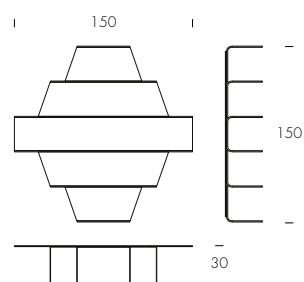

Master  
struttura noce Canaletto / Canaletto walnut structure (14).





# opera

M. Mottin | E. Barbieri

Opera, già sedia e porta-tv, ora completa la collezione con questa libreria, che può anche diventare un originale separatore di ambienti.

Opera, already present as sideboard and TV-stand, now completes the collection with this bookcase, which can also become an original room separator.

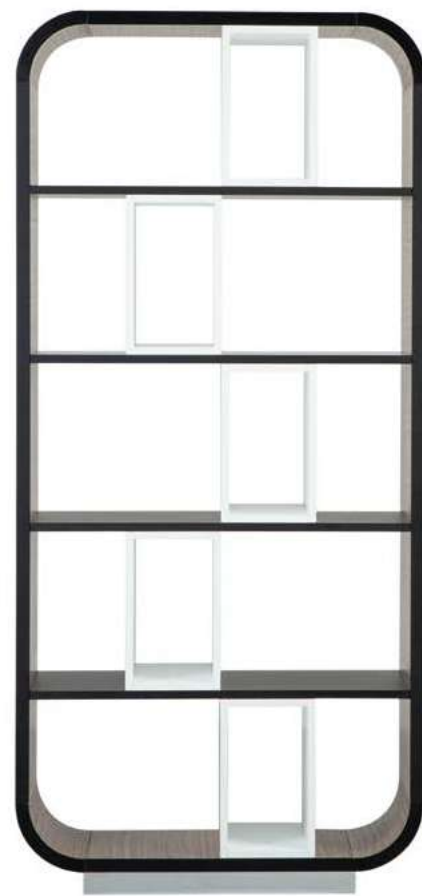
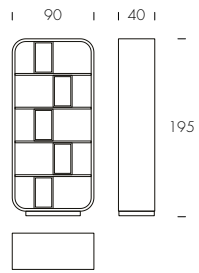

Opera  
struttura nero opaco e noce Canaletto, box bianco opaco/  
matt black and Canaletto walnut structure, matt white boxes (01).





# plan

Pierluigi Stella

Questa libreria è composta da una serie di mensole che creano movimento, interrompendo la continuità della parete. Oltre ai ripiani, si possono aggiungere anche dei cassettoni di varie dimensioni, così da avere più spazio contenitivo all'interno della zona living.

This bookcase is composed of a series of shelves that create movement, interrupting the continuity of the wall. In addition to the shelves, drawers of various sizes can also be added, so as to have more storage space inside the living area.

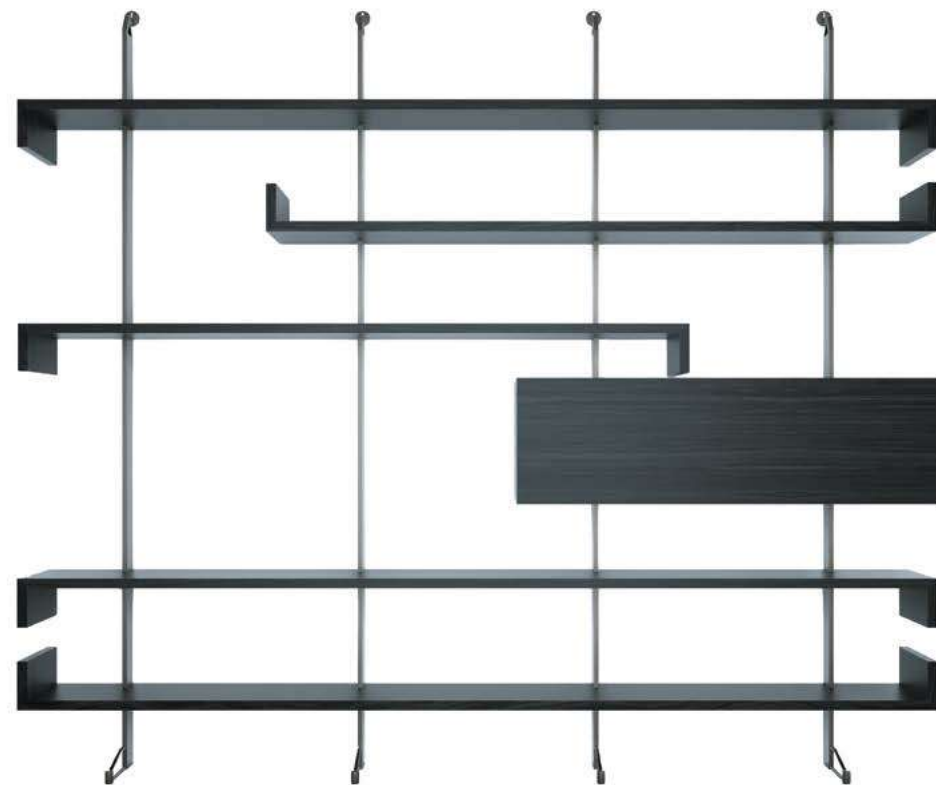
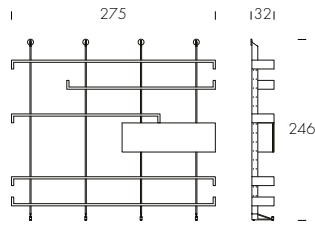

Plan  
struttura titanio/titanium structure (34);  
mensole e box frassino nero/black ash shelves and boxes (25).





Plan  
struttura titanio/titanium structure (34);  
mensole e box frassino nero/black ash shelves and boxes (25).











Plan  
 struttura bronzo pietra/stone bronze structure (83);  
 mensole e box noce Canaletto/Canaletto walnut shelves and boxes (14).



# sintesi

Opaca Lab

Un'ode alla geometria e alla linearità. Una libreria che conquista per le sue linee essenziali, che ben si fondono ad ogni tipo di ambiente, creando un'atmosfera raffinata ed elegante.

An ode to geometry and linearity. A bookcase that conquers with its essential lines, which blend well with any kind of space, creating a refined and elegant atmosphere.

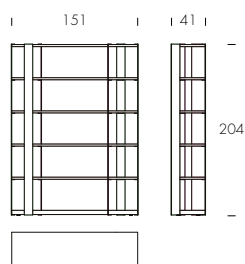

**Sintesi**  
struttura beige opaco/matt beige structure (36);  
ripiani frassino nero/black ash shelves (25).



# venus

Mottin M. | Barbieri E.

Le vetrine Venus nascono quale omaggio alla dea della bellezza, Venere. La struttura in legno e le varie dimensioni e tipologie delle vetrine rendono Venus unica e particolare. Bifacciale o con la trapuntatura a rombi, Venus è adatta ai più svariati stili d'arredamento. Con la sua luce interna risplende, come il pianeta Venere, di luce propria.

The Venus showcases are born as attribute to the goddess of beauty, Venus. The wooden structure and the various sizes and types of showcases make Venus unique and particular. Double-sided or with rhombus quilting, Venus is suitable for the most varied furnishing styles. With its light inside the window, shines, like the planet Venus, with its own light.

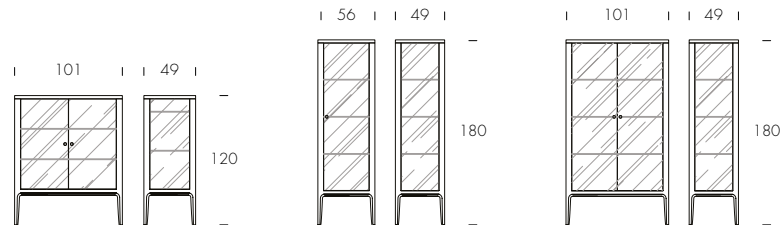





Venus

struttura frassino nero/black ash structure (25);  
ante vetro extrachiario trasparente/transparent extra-clear glass doors (V100);  
schienale vetro extrachiario trasparente e trapuntatura a rombi pelle beige/  
transparent extra-clear glass and beige leather rhombus pattern backrest (V100, P36).







# cora

Tonin Casa Creatives

Consolle allungabile dalle linee pure e delicate con base in acciaio verniciato, piano e prolunghe in melaminico, finitura in noce canaletto, rovere scuro. Carrello allunghe incluso.

Extendible console with pure and delicate lines and with painted steel base. Melamine top and extension, canaletto walnut, dark oak finish. Extension trolley included.

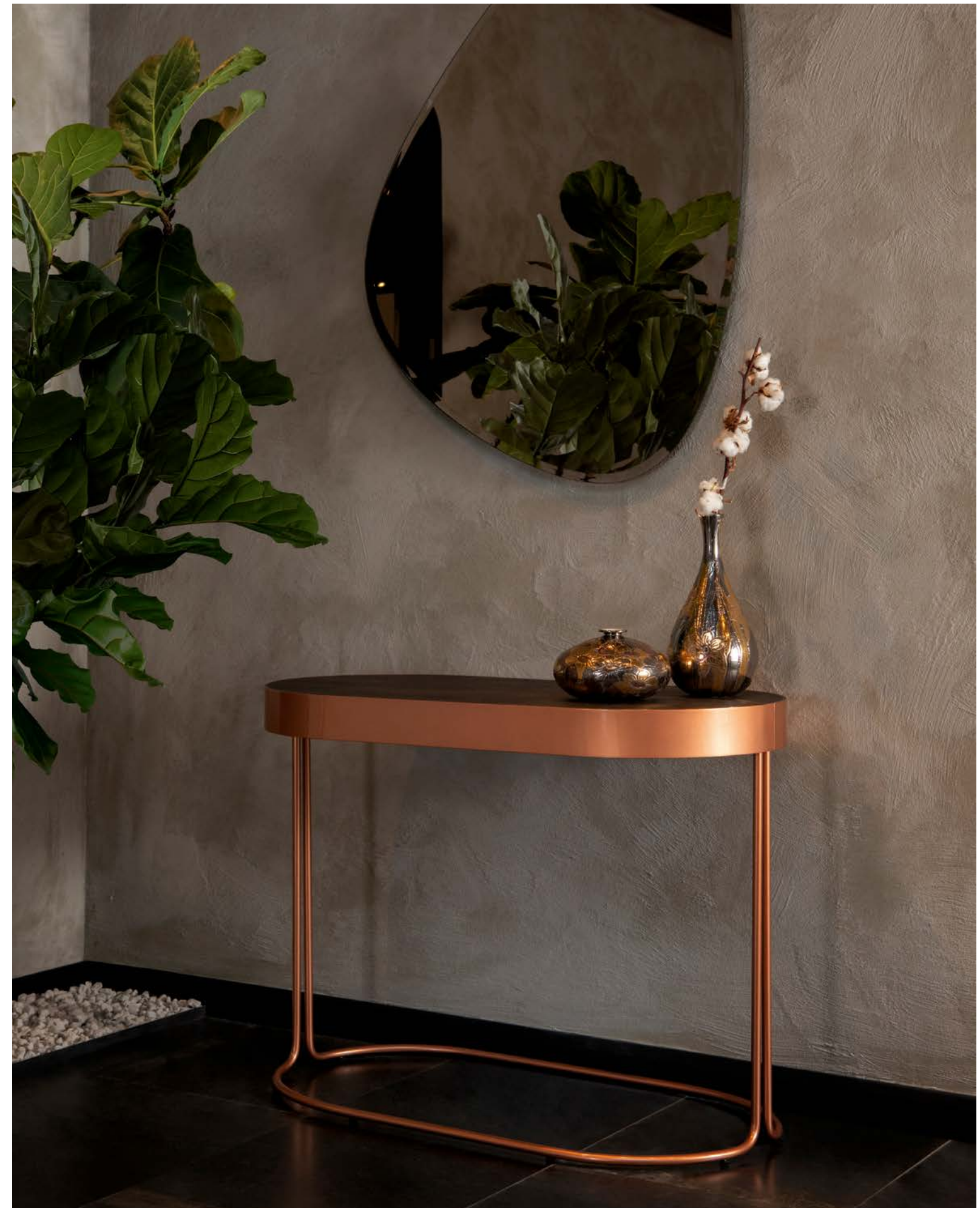
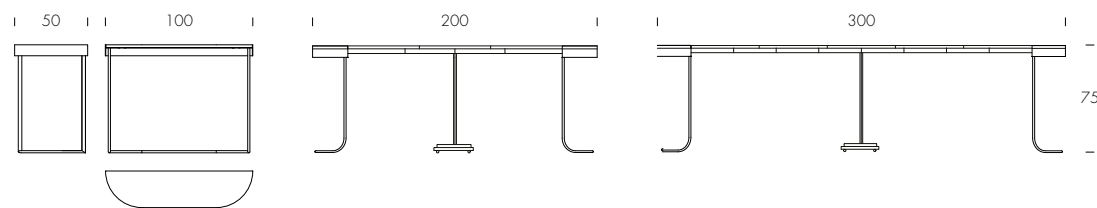



**Cora**  
struttura verniciato rame lucido / shiny copper varnished structure (75);  
top melaminico noce Canaletto / Canaletto walnut melamine top (PML5).





# eliseo

Tonin Casa Creatives

Una leggerezza elegante avvolge la consolle Eliseo, con base in acciaio nelle varie finiture. Piano in vetro, marmo e gres porcellanato.

An elegant lightness envelops the Eliseo console, with various finishes steel base. Glass, marble and porcelain top.

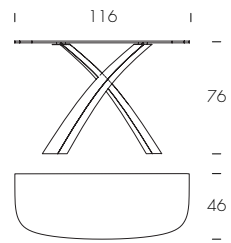

**Eliseo**  
base nero opaco/matt black base (02);  
top gres onice Ambra/onyx amber porcelain top (V55P).





# eliseo élite

Tonin Casa Creatives

La consolle Eliseo si arricchisce, nella versione Élite, di un ring in legno massello che avvolge i top nelle varie finiture di porcellanato.

The Eliseo console is enriched, in the Élite version, with a solid wood ring that wraps the tops in the various porcelain finishes.

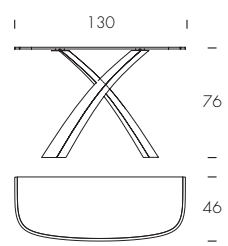

Eliseo élite  
base brushed bronzo/brushed bronze base (SP83);  
ring noce Canaletto/Canaletto walnut ring (114);  
top gres Crème lucido/shiny Crème porcelain top (V90P).





Eliseo élite  
base brushed bronzo/brushed bronze base (SP83);  
ring frassino nero/black ash ring (25);  
top gres Agata black/Agata black porcelain top (V95P).

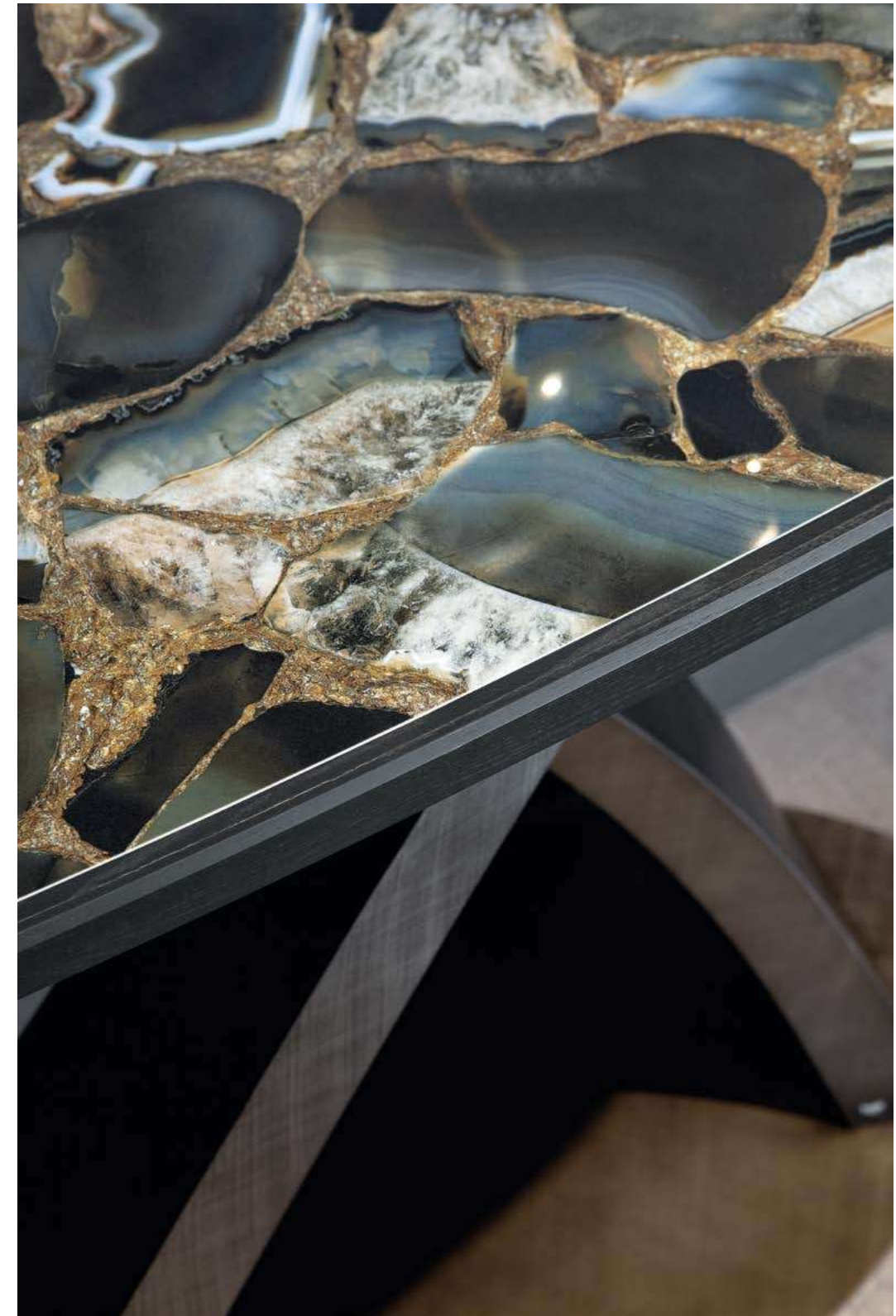



# leaf

Pravato Design

Consolle allungabile con base in acciaio verniciato, piano e prolunghe in melaminico, finitura in noce canaletto, rovere scuro. Carrello allunghe incluso.

Extendable console with painted steel base. Melamine top and extension, canaletto walnut, dark oak finish. Extension trolley included.

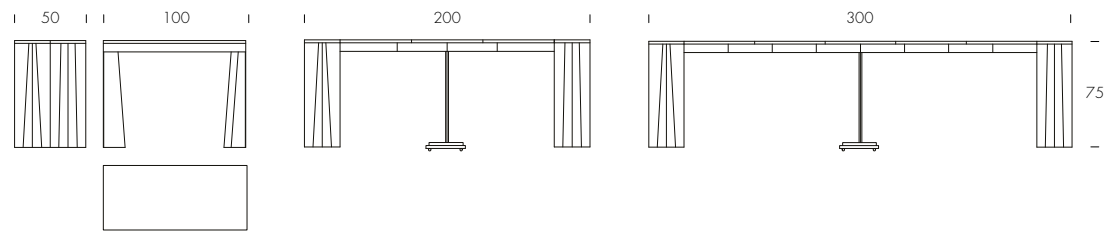



**Cora**  
struttura titanio / titanium structure (34);  
top melaminico noce Canaletto / Canaletto walnut melamine top (PML5).





# still

Angelo Tomaiuolo

Il legno curvato rimane la lavorazione più elegante e nobile che una forma di design può avere. È così per la consolle Still che, grazie alla sua pregiata lavorazione, infonde uno stile inconfondibile ad ogni spazio.

Curved wood remains the most elegant and noble workmanship that a design form can have. This is the case for the Still console which, thanks to its precious processing, gives an unmistakable style to any space.

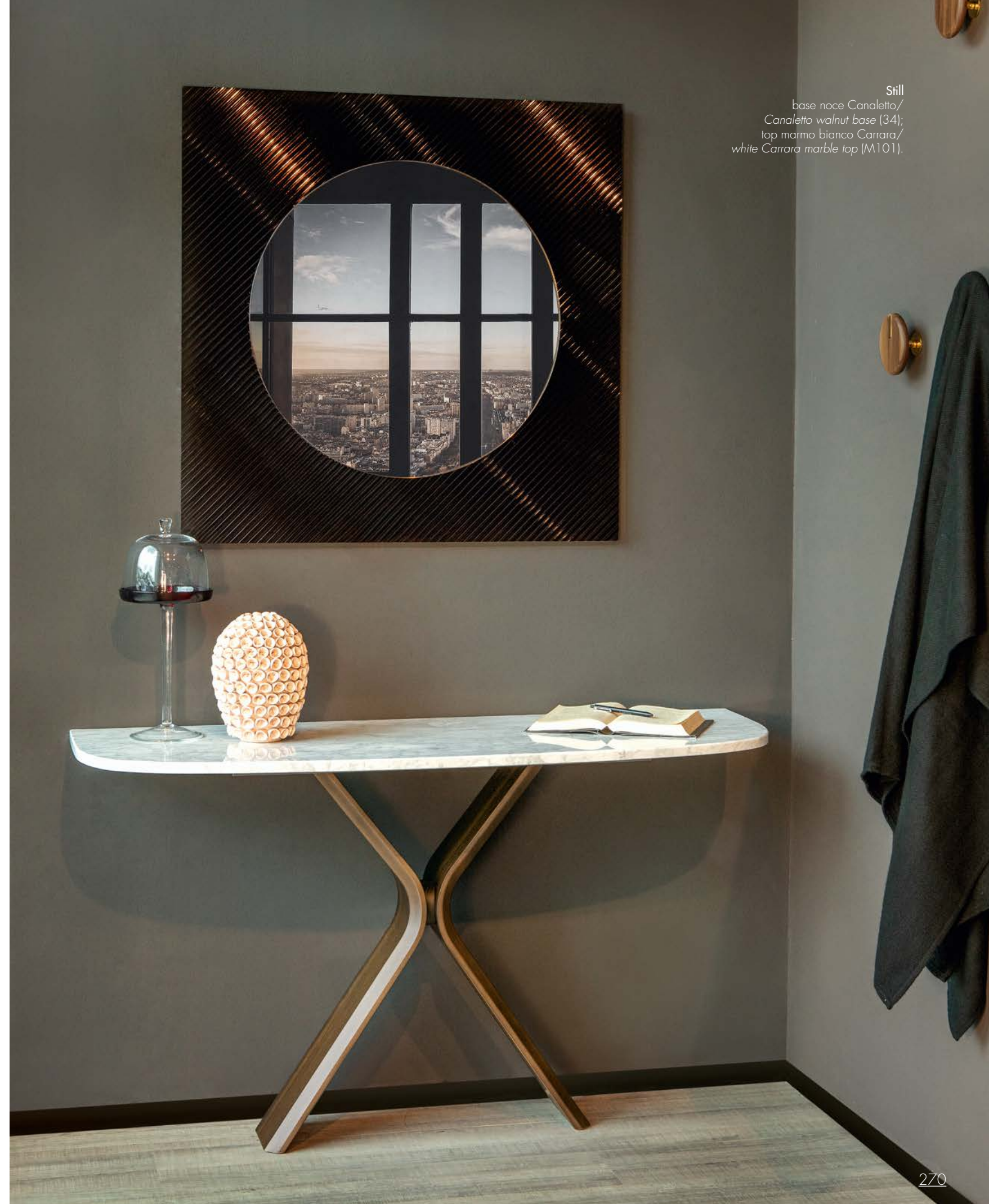
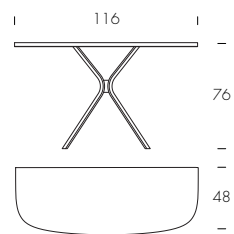

Still  
base noce Canaletto/  
Canaletto walnut base (34);  
top marmo bianco Carrara/  
white Carrara marble top (M101).



# still élite

Angelo Tomaiuolo

Il legno curvato rimane la lavorazione più elegante e nobile che una forma di design può avere. È così per la consolle Still che, grazie alla sua pregiata lavorazione, infonde uno stile inconfondibile ad ogni spazio, arricchita, nella versione Élite, dall'elegante ring in legno massello.

Curved wood remains the most elegant and noble workmanship that a design form can have. This is the case for the Still console which, thanks to its precious processing, gives an unmistakable style to any space, enriched, in the Élite version, by the elegant solid wood ring.

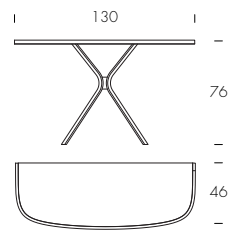

**Still élite**  
base frassino nero/black ash base (25);  
ring frassino nero/black ash ring (25);  
top gres Statuario Altissimo/  
Statuario Altissimo porcelain top (V01P)









# ànemos

Giuseppe Maurizio Scutellà

La lieve brezza dell'eleganza può soffiare in qualunque stanza con lo specchio Anemos, il cui nome allude al vento che sembra muovere l'elemento specchiante, un pezzo dal design intriso di fascino che testimonia la continua ricerca di tecniche di lavorazione uniche e preziose.

The gentle breeze of elegance can blow in any room with the Anemos mirror, whose name alludes to the wind that seems to move the mirror element, a design piece imbued with charm that testifies to the continuous search for unique and precious processing techniques.

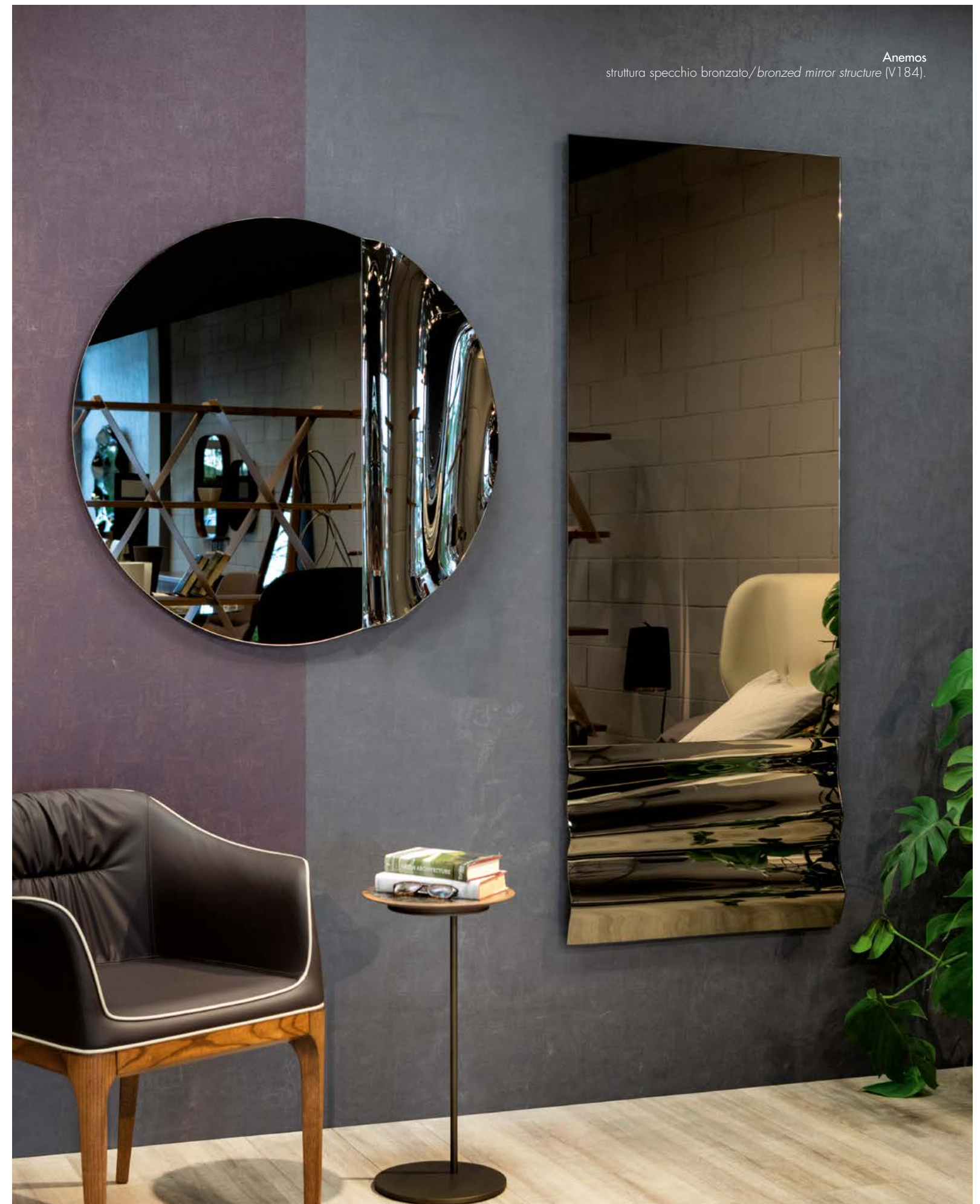
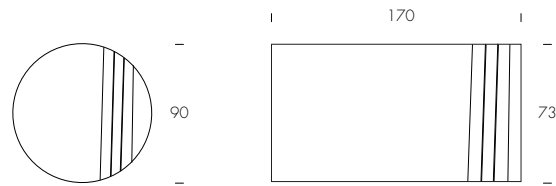

Anemos  
struttura specchio bronzato/bronzed mirror structure (V184).



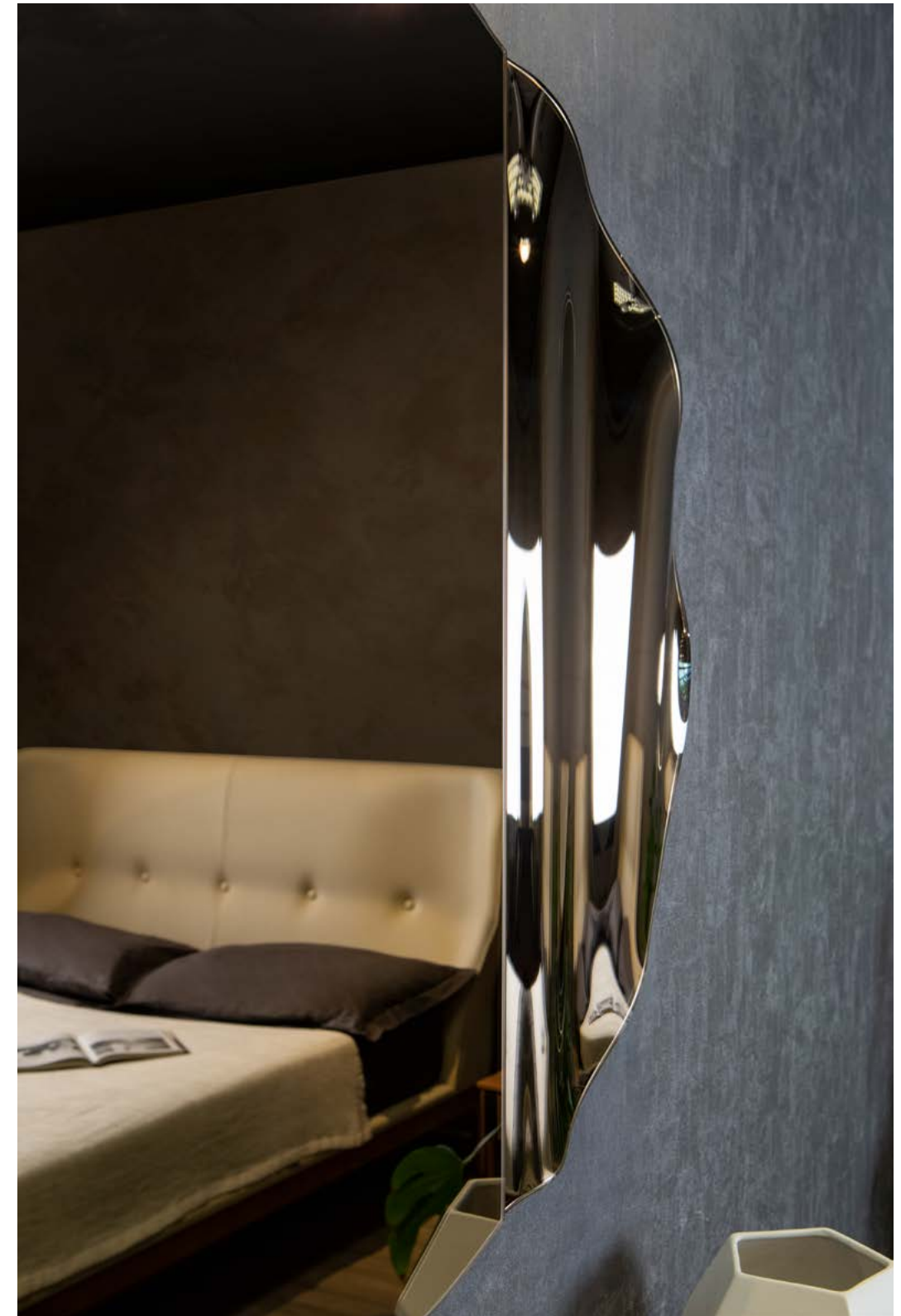



# daisy

Tonin Casa Creatives

Il nuovo specchio Daisy richiama l'armonia dei petali di una margherita, donando un tocco di raffinata leggerezza ad ogni parete.

The new Daisy mirror recalls the harmony of the petals of a daisy, giving a touch of refined lightness to each wall.

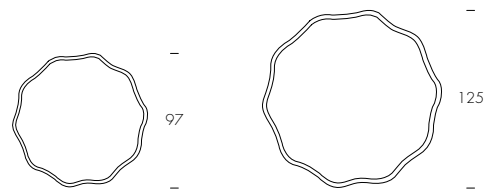

Daisy  
struttura specchio argentato / silver mirror structure (V45).





# decò

Tonin Casa Creatives

La particolare lavorazione curvata del vetro ricotto è la cifra stilistica che caratterizza questo specchio dall'estetica potente.

The particular curved processing of the annealed glass is the stylistic feature that characterizes this mirror which as powerful aesthetic.

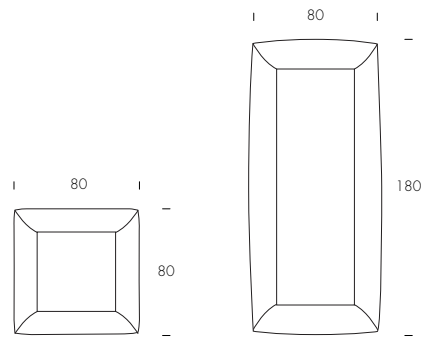

Decò  
struttura specchio argentato / silver mirror structure (V45).





# dorian

LM Design - E. Barbieri

Bellezza e piacere come suprema forma d'arte: lo specchio Dorian è un inno al romanzo di Oscar Wilde, "Il ritratto di Dorian Gray". Per celebrare quello che è diventato una sorta di manifesto della sua poetica, nasce questo specchio dall'estetica imponente, che diventa raffinato protagonista di design, con l'eleganza di Tonin Casa.

Lo specchio Dorian è caratterizzato da una sofisticata cornice rotonda dalla particolare lavorazione a corolla in vetro curvo argentato, con tonalità bronzo e fumè. È disponibile in due varianti di misura con diametro 120 e 200 cm.

Beauty and pleasure as the supreme form of art: the Dorian mirror is a hymn to Oscar Wilde's novel, "The Portrait of Dorian Gray". To celebrate what has become a sort of manifesto of his poetics, this mirror is born with an imposing aesthetic, which becomes a refined design protagonist, with the elegance of Tonin Casa.

The Dorian mirror is characterized by a sophisticated round frame with a particular corolla processing in silvered curved glass, with bronze and fumè shades. It is available in two sizes with a diameter of 120 and 200 cm.

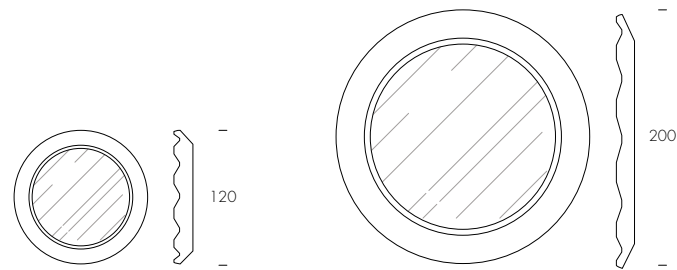

Dorian  
struttura specchio fumè/fumè mirror structure (VS87).





Dorian  
struttura specchio bronzato / bronzato mirror structure (V184).

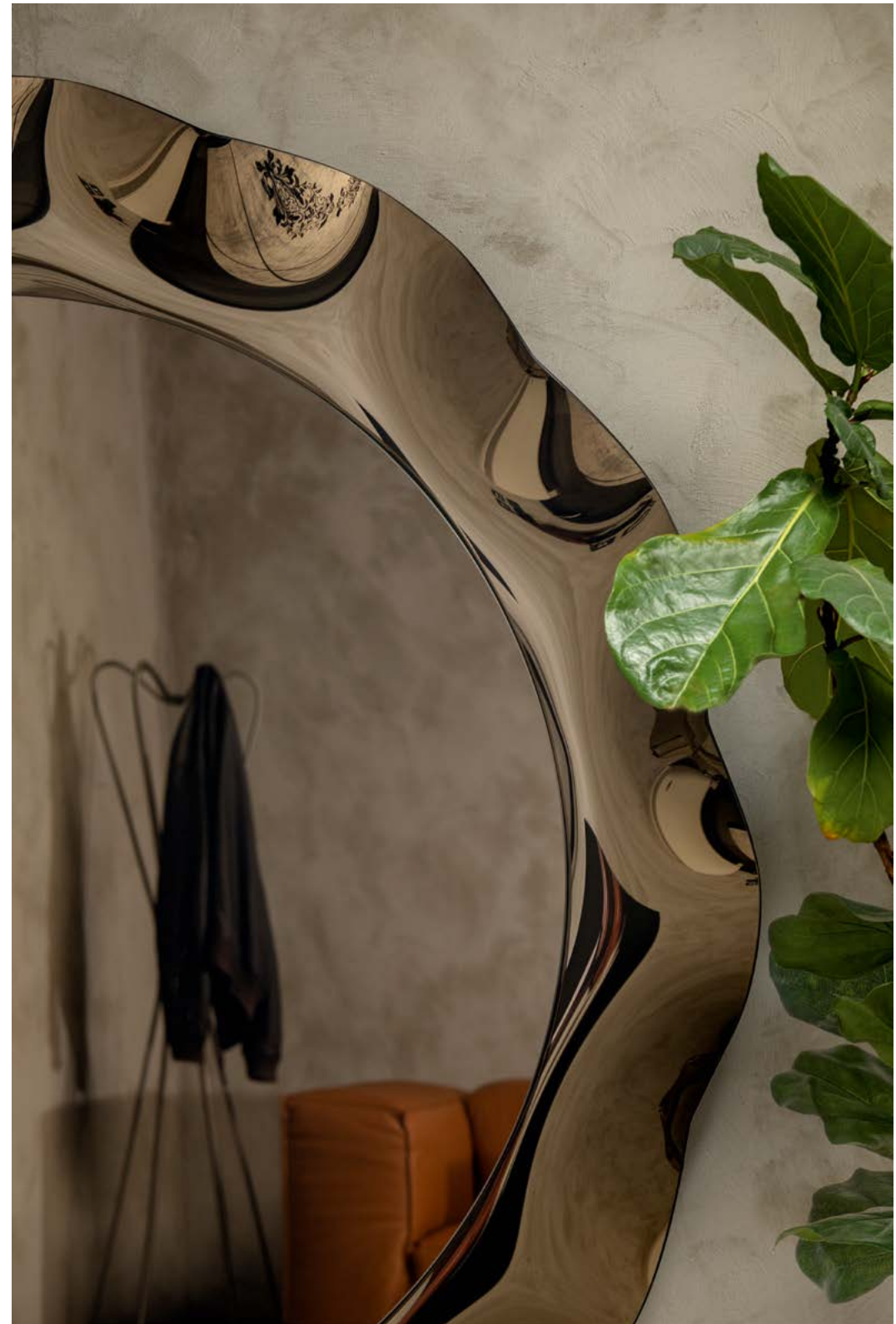



# enigma

Plurimo Design

Il fascino di una forma indefinita svela l'uso di uno specchio dietro un orologio dal design essenziale: è Enigma, in cristallo serigrafato, per un'inedita soluzione dal design delicato e potente.

The charm of an indefinite shape reveals the use of a mirror behind a watch with an essential design: it is Enigma, in silk-screened crystal, for an unprecedented solution with a delicate and powerful design.

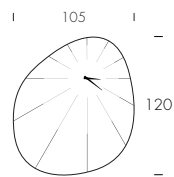

Enigma  
struttura specchio argentato / silver mirror structure (V45).





# era ora

LM Design | Nicola Aureli

Era Ora, in vetro specchiato fumè o bronzo, è un orologio/specchio impreziosito da inserti in vetro cannettato che rendono ancor più elegante la sua forma pura.

Era Ora, in fumè or bronze mirrored glass, is a clock/mirror embellished with ribbed glass inserts that make its pure form even more elegant.

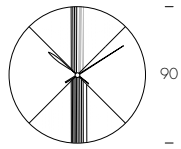

Era Ora  
struttura specchio fumè/fumè mirror structure (VS87).





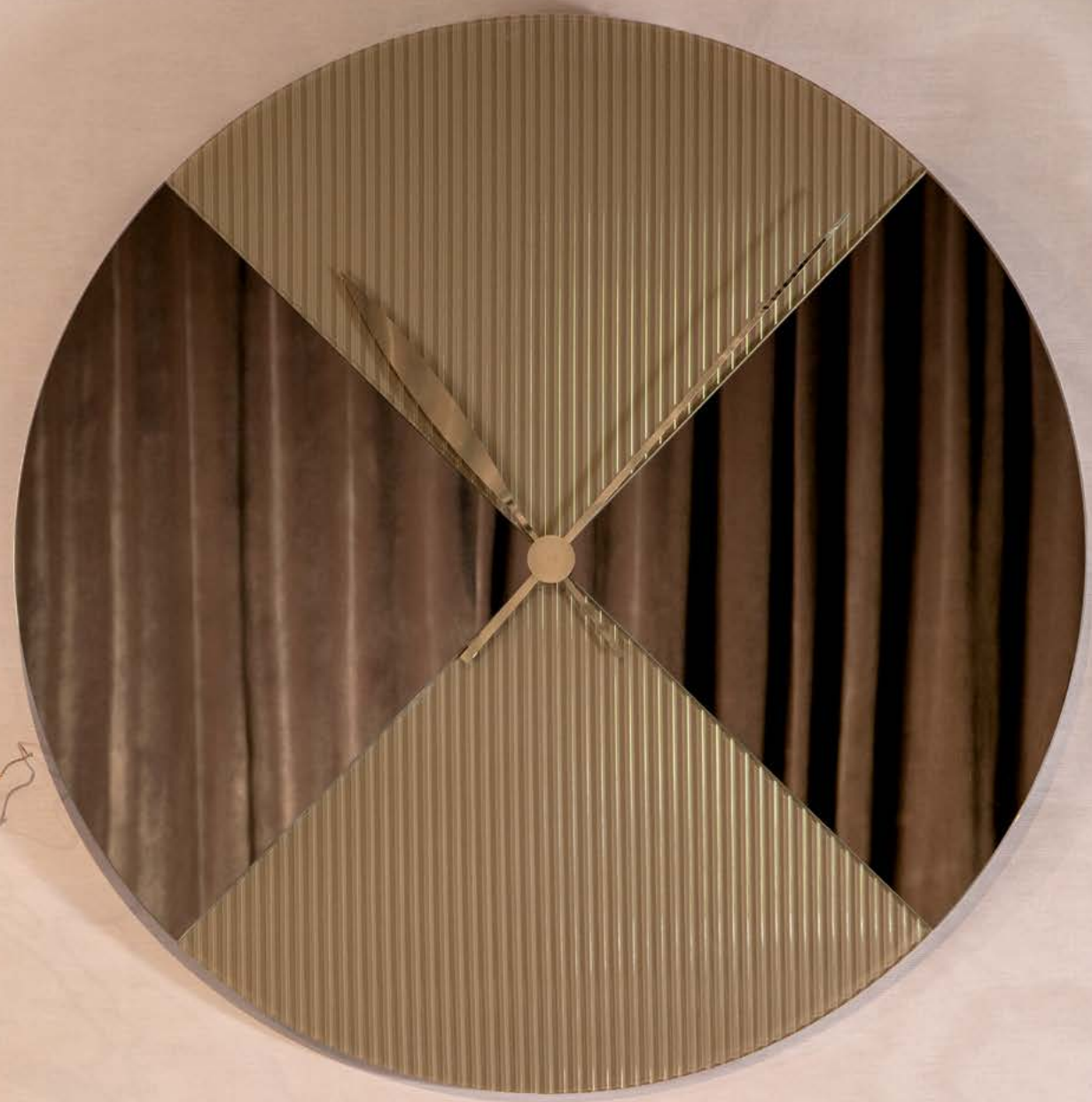

Era Ora  
struttura specchio bronzo/bronzed mirror structure (V184).





# fusion

Plurimo Design

Due cerchi sovrapposti a creare un complemento di design unico: due mondi, dai numeri arabi e romani si incontrano nell'unicità di Fusion, dove lo specchio si fonde con l'orologio e le finiture del cristallo bronzo e fumè donano un tocco di affascinante preziosità all'elemento specchiante.

Two overlapping circles to create a unique design complement: two worlds, with Arabic and Roman numbers meet in the uniqueness of Fusion, where the mirror merges with the clock and the bronze and fumè crystal finishes give a touch of fascinating preciousness to the mirror element.

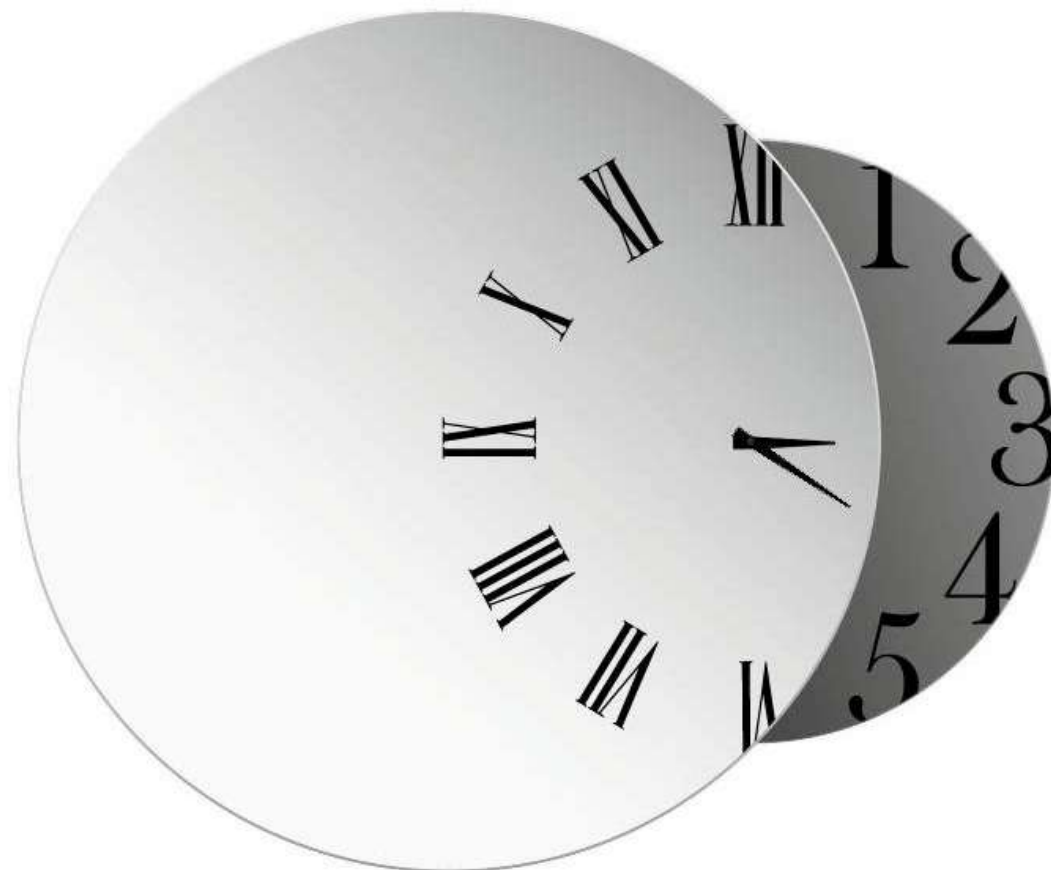
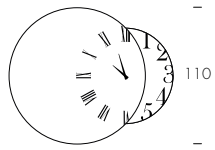

Fusion  
struttura specchio argento e bronzato/silver and bronzed mirror structure (V45, V184).



# glamour

Tonin Casa Creatives

Tre misure per il nuovo specchio Glamour che grazie alla sua linea pura e alla bisellatura perimetrale arricchisce lo stile di ogni parete.

Three sizes for the new Glamour mirror which, thanks to its pure line and the perimeter bevel, enriches the style each wall.

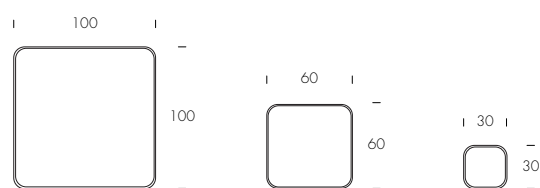



Glamour  
struttura specchio argentato / silver mirror structure (V45).





# io&te

Luca Roccadadria

In versione argentata e bronzata, io&Te sono due specchi che si sovrappongono, complementari. Disponibili in due misure.

In silver and bronze version, io&Te are two mirrors that overlap each other, complementary. Available in two sizes.

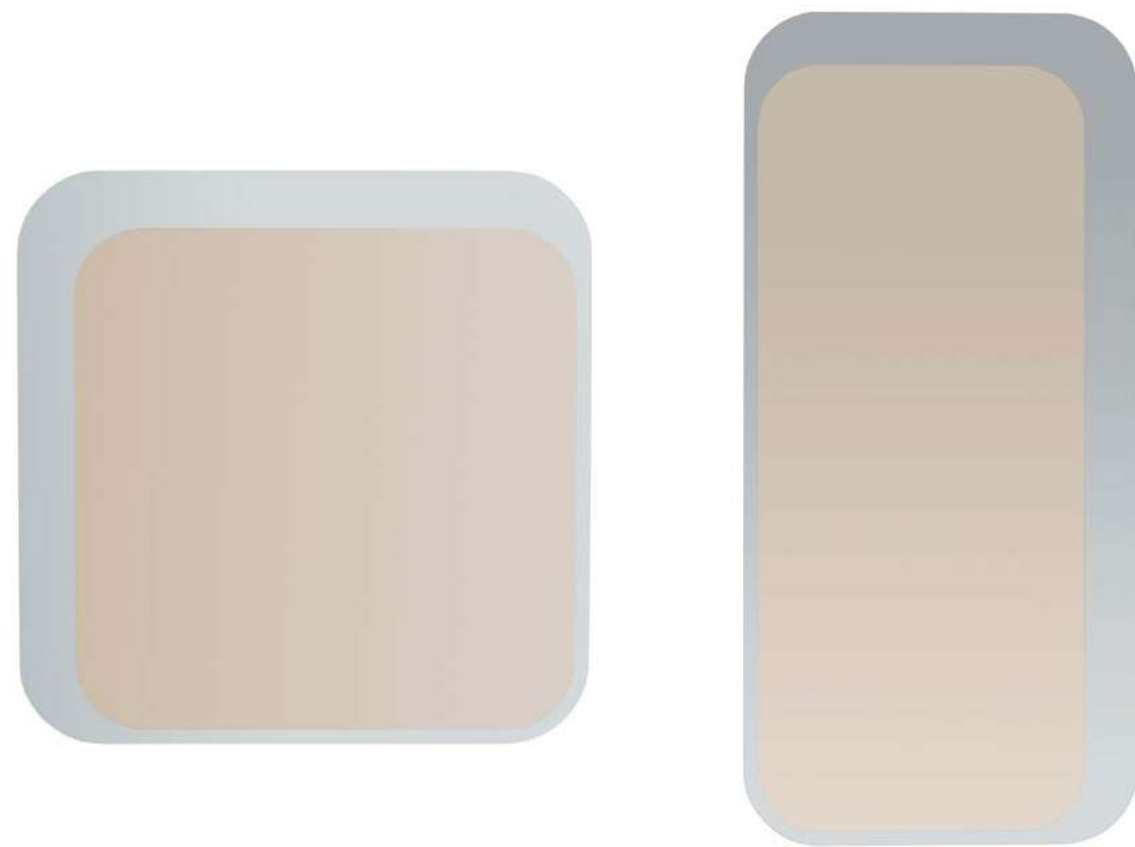
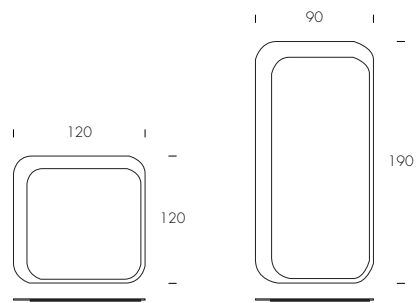

io&Te  
struttura specchio fumè e bronzato / fumè and bronzed mirror structure (V184).

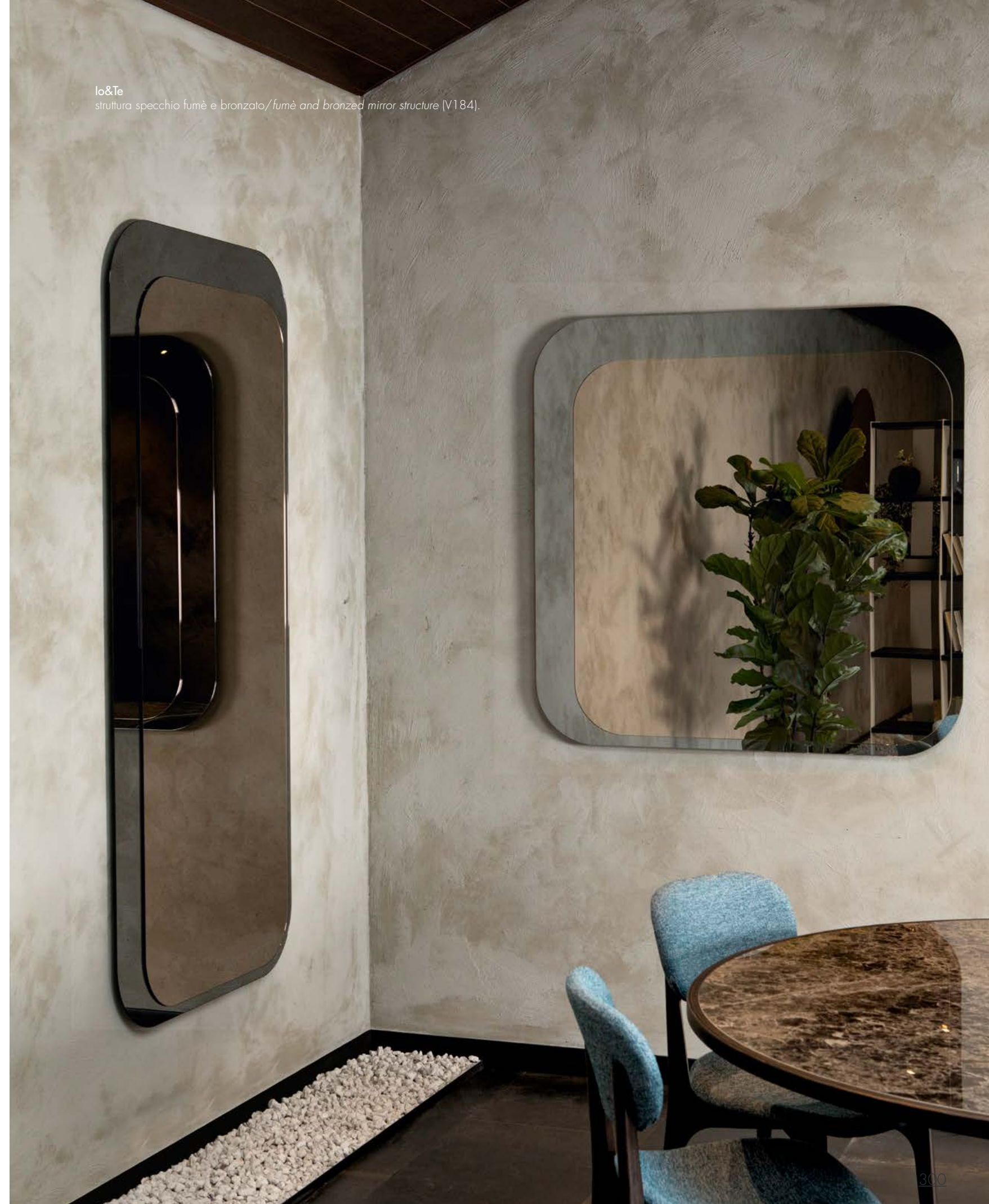



# leave

Luca Roccadadria

leave è uno specchio dalla forma tonda con un preciso e distintivo dettaglio: un orologio dall'elegante finitura in porcellanato. Due oggetti e due forme che si uniscono, una sull'altra.

leave is a mirror with a round shape with a precise and distinctive detail: a clock with an elegant porcelain finish. Two objects and two shapes that come together, one on top of the other.

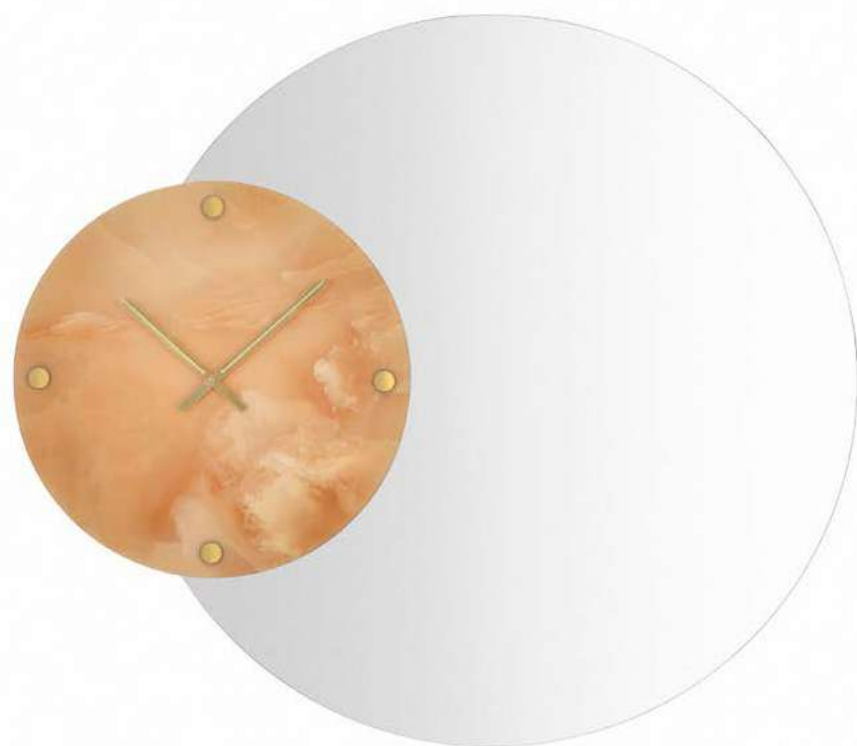
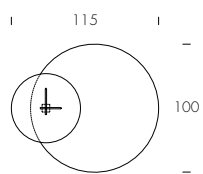

Leave  
struttura specchio argentato / silver mirror structure (V45);  
effetto gres onice ambra / onyx amber porcelain effect (V55P).





# lost

G. Codato | L. Trevisiol

Gli specchi Lost sono il perfetto connubio di bellezza essenziale e praticità. Funzionano da elementi specchianti e da appendiabiti, grazie alla struttura in metallo a V. Ideali per ogni tipo di ingresso, grazie alle tre differenti varianti di dimensione.

Lost mirrors are the perfect combination of essential beauty and practicality. They function as coat-hangers and as mirror elements, thanks to the V-shaped metal structure. Ideal for any type of entrance, thanks to the three different size variants.

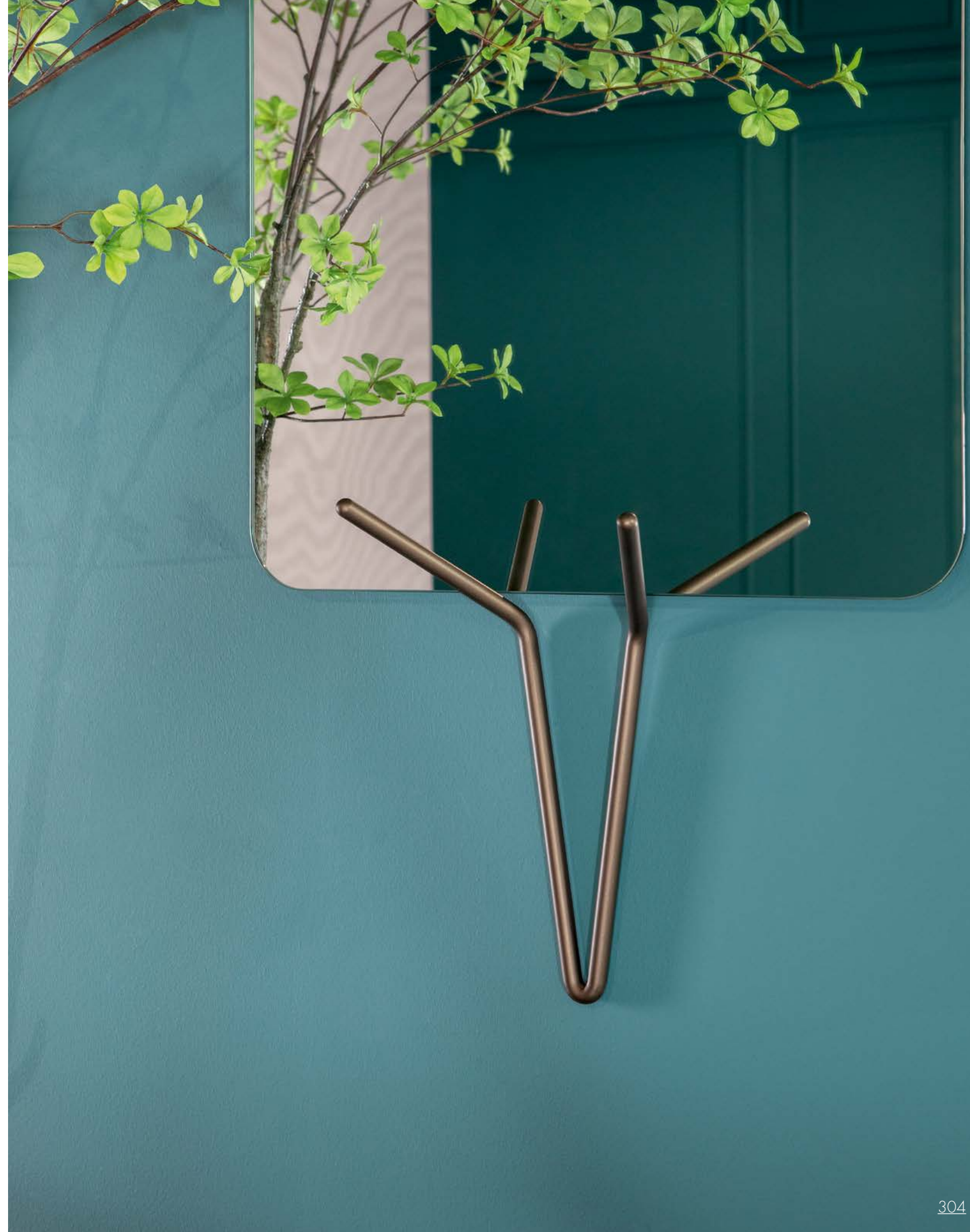
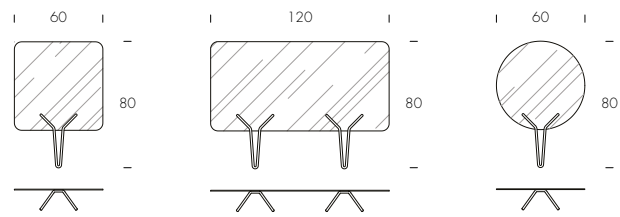





Leave  
specchio argentato/  
silver mirror (V45);  
struttura bronzo pietra/  
stone bronze structure (83).



# memphis

Plurimo Design

Gli ingranaggi del tempo si svelano nell'orologio/specchio Memphis, con dettagli bronzo su vetro serigrafato specchiato, un elemento d'arredo dall'originale effetto estetico.

The gears of time are revealed in the Memphis clock/mirror, with bronze details on mirrored silk-screened glass, a piece of furniture with an original aesthetic effect.

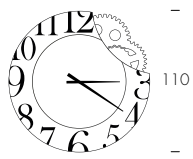

Memphis  
struttura specchio argentato/silver mirror structure (V45).





# oblio

Studio Archirivolto

Gli specchi Oblio sono caratterizzati dalla struttura in metallo e da una parte specchiante in altrettante varianti. Le sue forme ridefiniscono un nuovo modo di vedere lo specchio, che coniuga estetica e funzionalità.

Oblio mirrors are characterized by a metal structure and a mirroring part in as many variations. Its forms redefine a new way of looking at the mirror, which combines aesthetic and functionality.

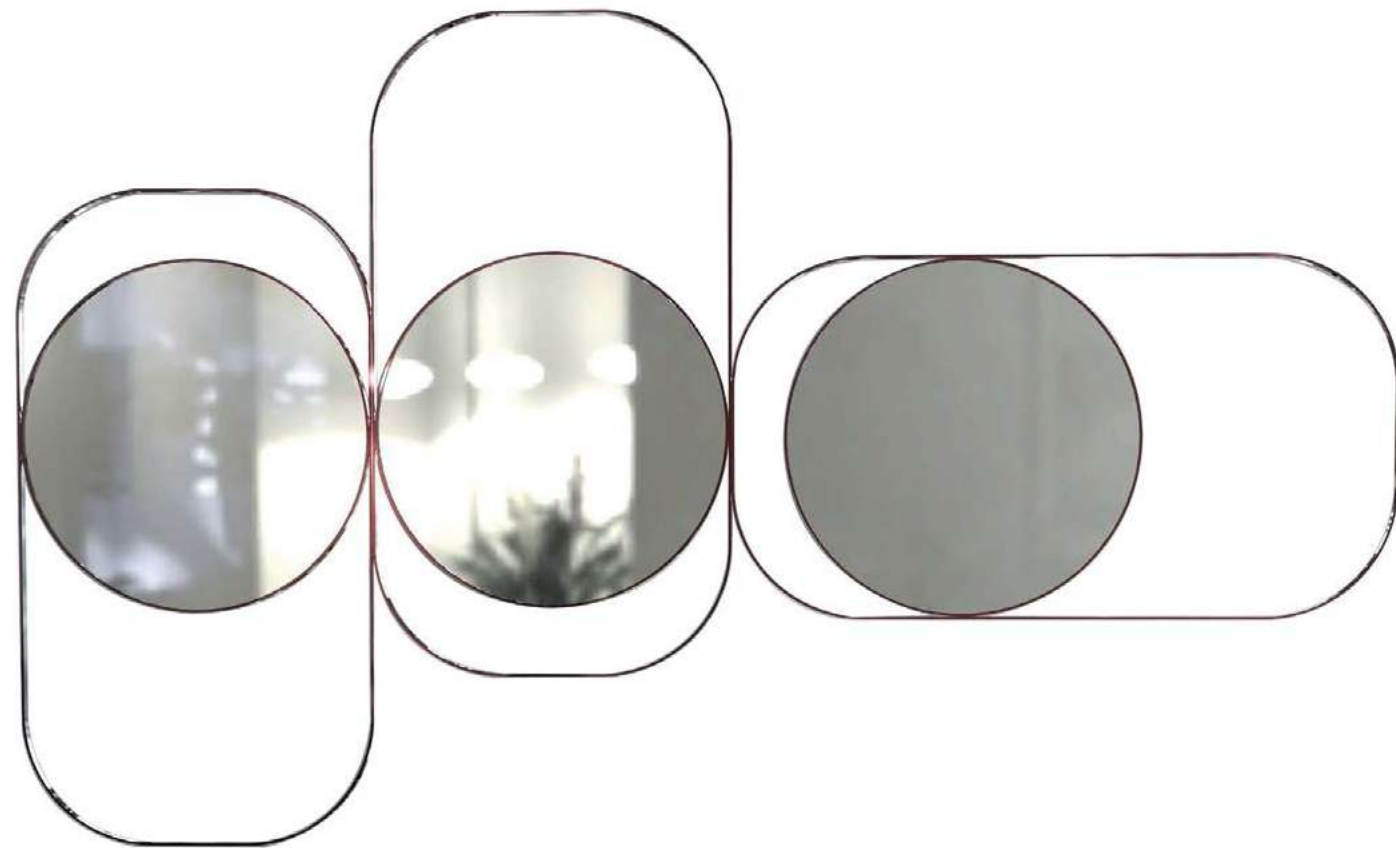
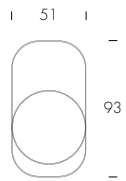

Oblio  
specchio bronzato/bronzed mirror (V184);  
struttura bronzo pietra/stone bronze structure (83).





# opal

LM Design

Lo specchio rotondo da parete Opal è caratterizzato dalla particolare lavorazione in vetro martellato, prodotta in esclusiva dai nostri maestri vetrai. Un elemento di design dalla forte identità, perfetto per donare eleganza ad ogni spazio living. Disponibile in finitura bronzo e fumè e due varianti di misura.

The round wall mirror Opal is characterized by the particular hammered glass processing, produced exclusively by our glass masters. A design element with a strong identity, perfect for giving elegance to any living space. Available in bronze and fumè finish and two different sizes.

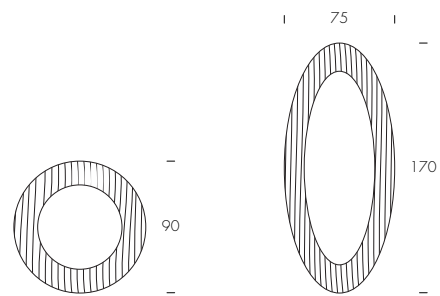

Opal  
cornice vetro martellato bronzo/bronze hammered glass frame (V83M);  
specchio bronzato/bronzed mirror (V184).







Opal  
cornice vetro martellato fumè/fumè hammered glass frame;  
specchio fumè/fumè mirror (VS87).





# otello

LM Design

Lo specchio da parete Otello fonde due forme opposte attraverso una particolare lavorazione rigata della cornice, impreziosita da una texture cannetè a righe oblique: le finiture del vetro cannettato a rilievo conferiscono tridimensionalità e esaltano l'elemento specchiante, rendendolo un oggetto di design unico.

The Otello wall mirror blends two opposite shapes through a particular striped processing of the frame, embellished with a cannetè texture with oblique lines: the finishes of the ribbed glass in relief give three-dimensionality and enhance the mirror element, making it a unique design object.

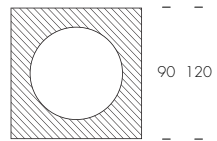

Otello  
cornice vetro cannettato blu/blue ribbed glass frame;  
specchio argentato/silver mirror (V456).



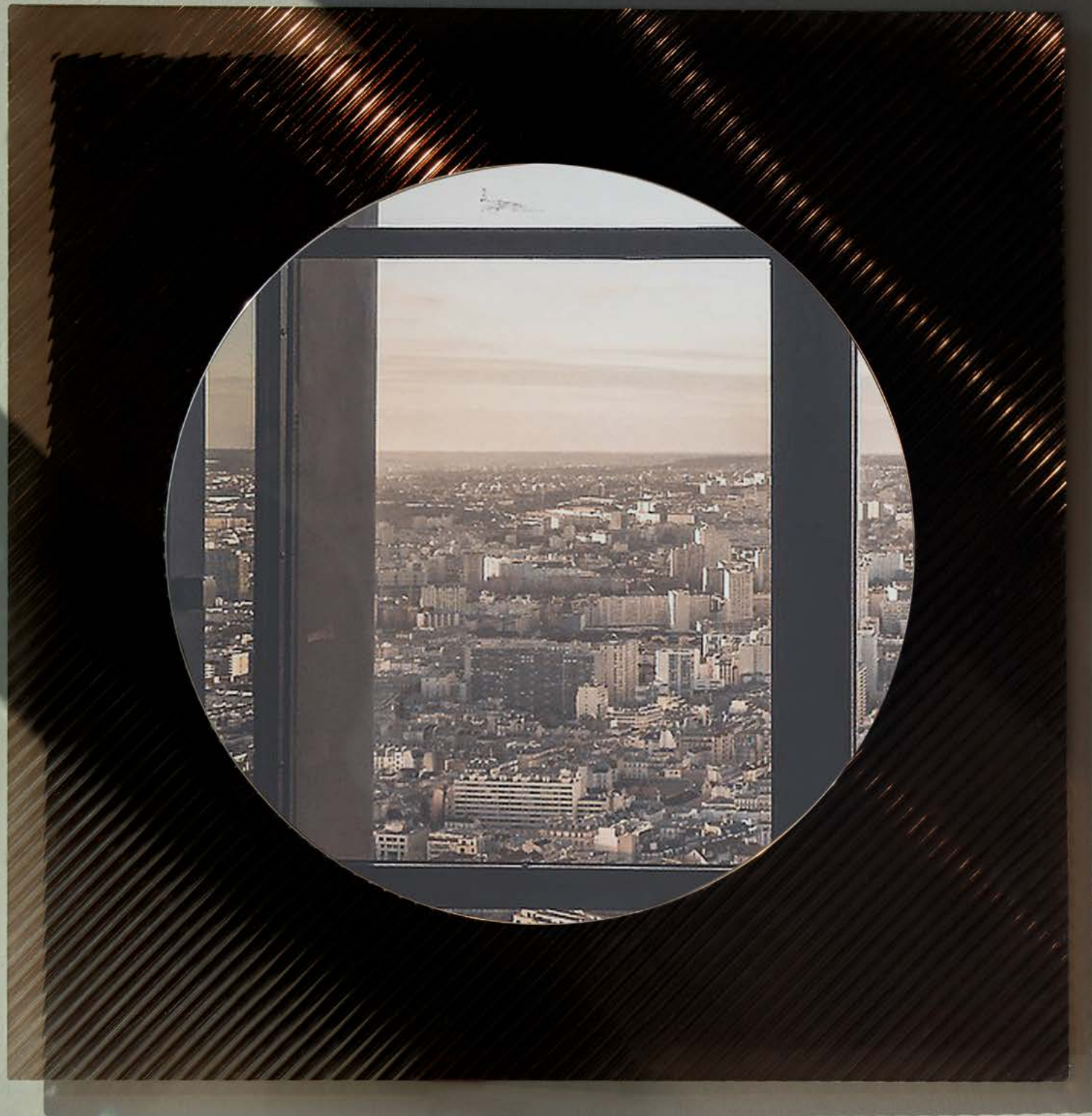

Otello  
cornice vetro cannettato bronzo/bronze ribbed glass frame;  
specchio bronzato/bronzed mirror (V184).

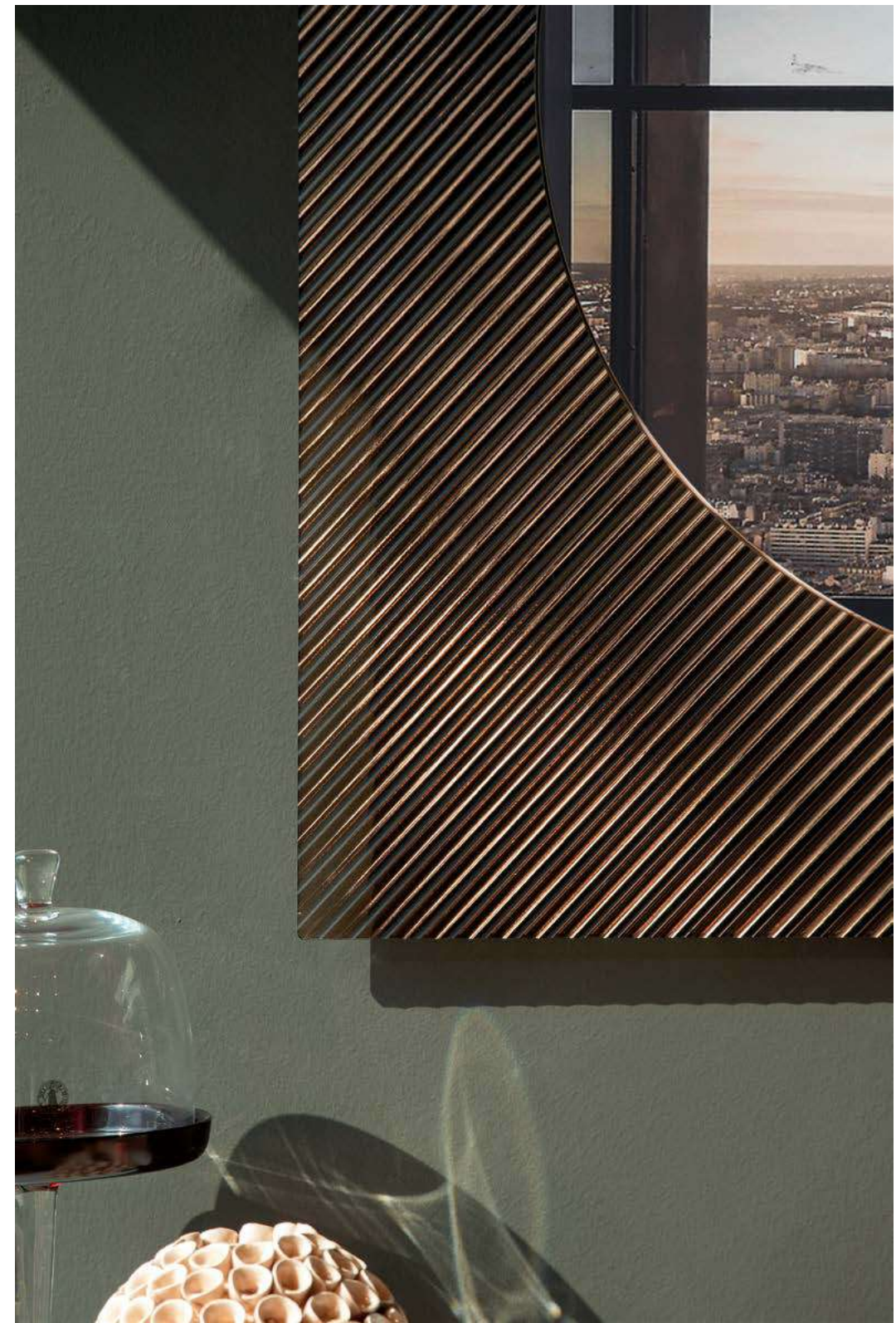



# sottosopra

M. Mottin | E. Barbieri

SottoSopra, come tu lo vuoi: il nome di questo specchio nasce dalla particolarità del suo design e dalla possibilità di essere disposto in qualunque modo si desideri. SottoSopra si compone di due specchi sovrapposti, argento e nero, in un gioco raffinato di contrasti di luci e ombre, dato dalle diverse finiture delle parti specchianti, un incontro di più dimensioni e di molteplici utilizzi. Uno specchio iconico dallo spirito versatile che con le sue forme morbide e essenziali si integra perfettamente in ogni spazio.

SottoSopra, as you want it: the name of this mirror comes from the particularity of its design and from the possibility of being arranged in any way you want. SottoSopra consists of two superimposed mirrors, silver and black, in a refined game of contrasts of light and shadow, given by the different finishes of the mirror parts, a meeting of multiple dimensions and multiple uses. An iconic mirror with a versatile spirit that with its soft and essential shapes integrates perfectly into any space.

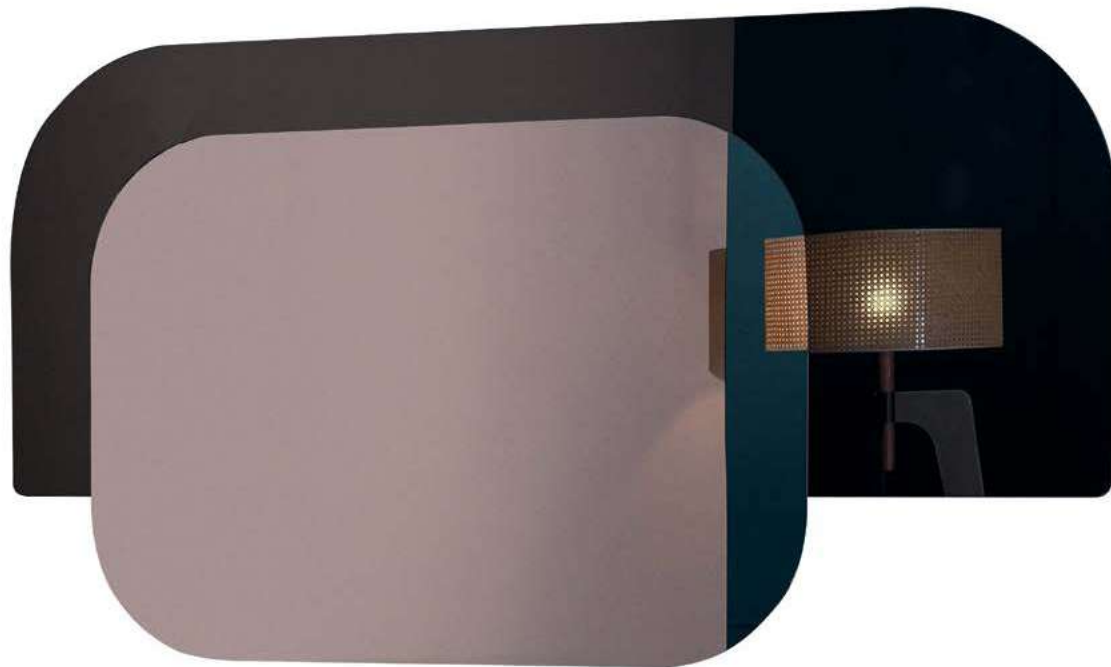
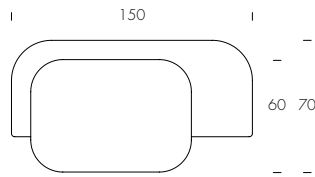

Sottosopra  
cornice specchio nero/black mirror frame;  
specchio argentato/silver mirror (V45).





# stone élite

Angelo Tomaiuolo

Una parete può essere valorizzata non soltanto da dei quadri, ma anche dall'utilizzo saggio e creativo di specchi di varie dimensioni. Questo gioco di forme e fantasia è reso possibile dai nuovi specchi Stone Élite, proposti in questa versione con elegante bisellatura perimetrale.

A wall can be enhanced not only by paintings, but also by the wise and creative use of mirrors in various sizes. This play of shapes and fantasy is made possible by the new Stone Élite mirrors, proposed in this version with elegant perimeter bevel.

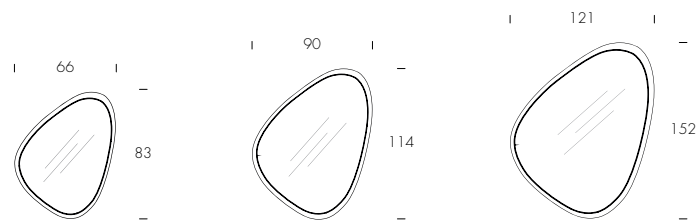

Stone élite  
struttura specchio bronzato/bronzed mirror structure (V184).



# tower

Artefatto Design Studio

Lo specchio Tower, che ricorda una torre pendente, con la sua forma insolita, minimale e originale, si adatta a chi vuole uscire dall'ordinario, per rendere anche un semplice spazio straordinario.

The Tower mirror, reminiscent of a leaning tower, with its unusual, minimal and original shape, is suitable for those who want to get out of the ordinary, to make even a simple extraordinary space.

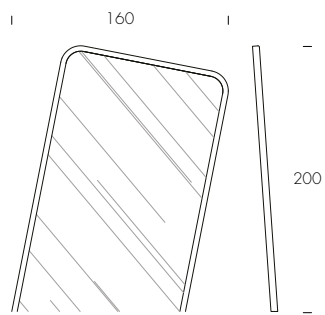

Tower  
specchio argentato/silver mirror (V45);  
cornice noce Canaletto/Canaletto walnut frame (14).



# vogue

Andrea Lucatello

Specchio dalle linee morbide e dinamiche con cornice curva in acciaio verniciato, che grazie alle diverse profondità funge anche da comoda mensola. Proposto in due dimensioni.

Mirror with soft and dynamic lines with curved frame in painted steel, which thanks to the different depths also acts as a shelf. Proposed in two dimensions.

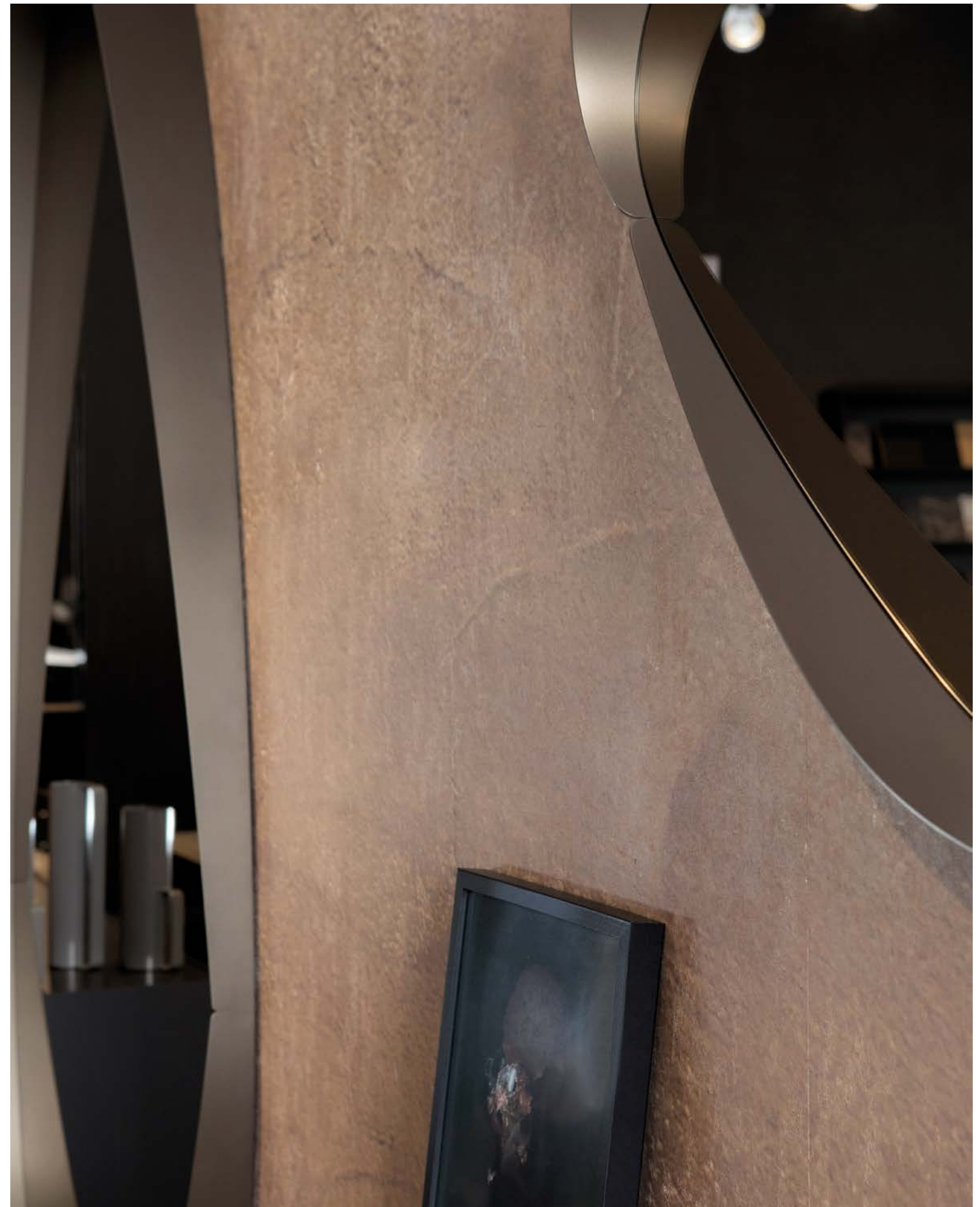
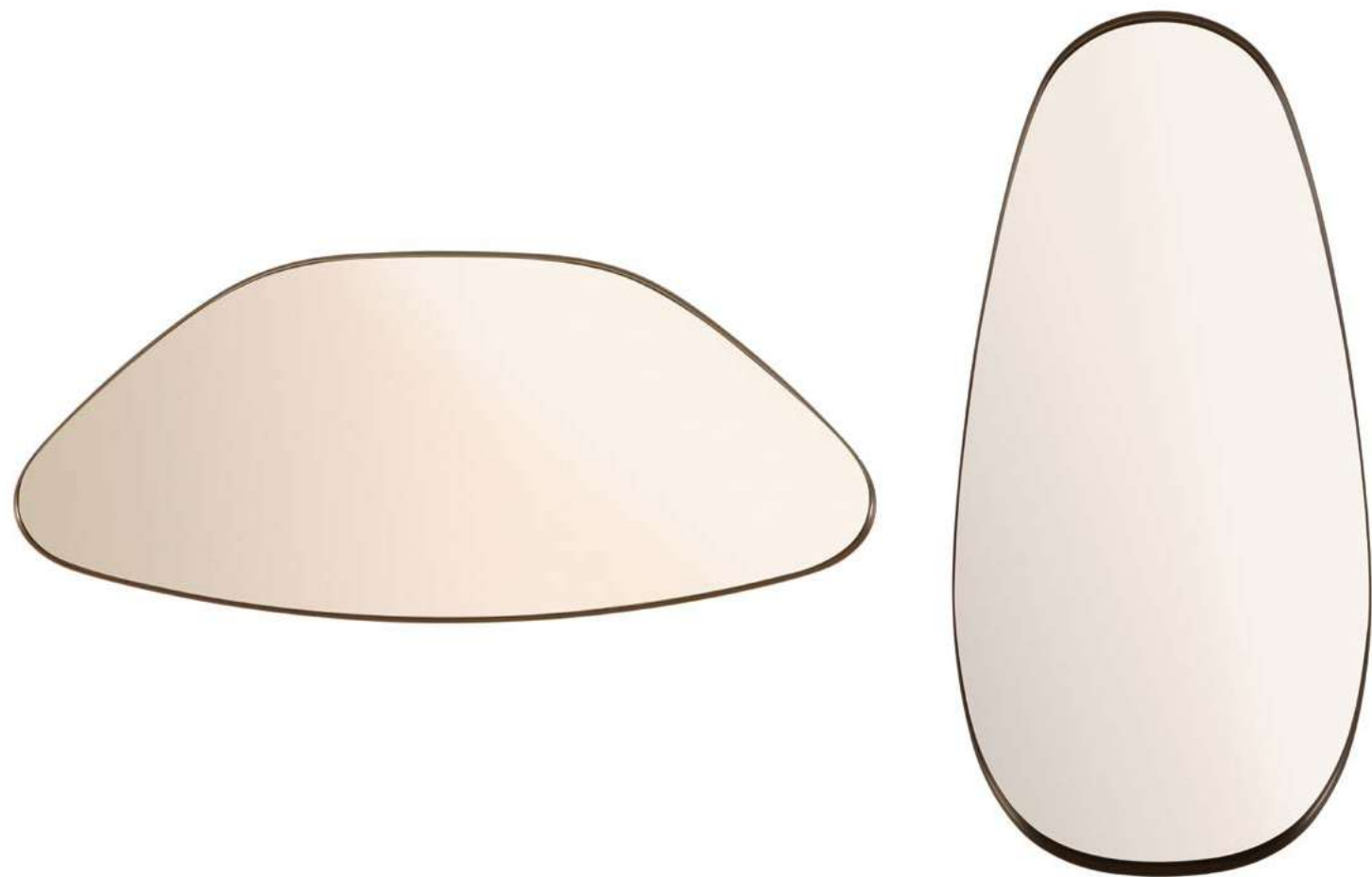
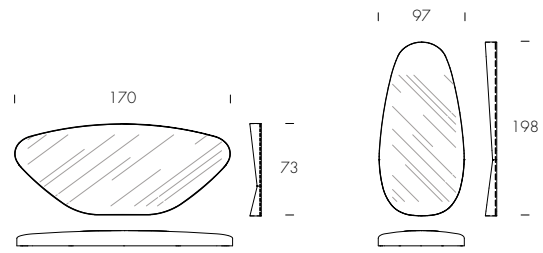



Vogue  
specchio bronzato/bronzed mirror (V184);  
struttura bronzo pietra/stone bronze structure (83).









# audrey

Opaca Lab

Portaombrelli in metallo verniciato, dal design che richiama i petali dischiusi di un fiore: un accessorio capace di donare luminosità ed eleganza ad ogni ambiente. Dotato di funzionale vaschetta scolapioggia.

Umbrella stand in painted metal, with a design that recalls the open petals of a flower: an accessory capable of giving brightness and elegance to any environment. Equipped with functional rain drain tray.

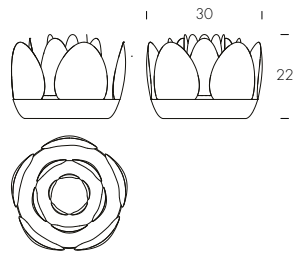

Audrey  
struttura bronzo pietra/stone bronze structure (83).





# baobab

Lorenzo Zanovello

Tavolini interamente realizzati in ceramica, dalla lavorazione artigianale 100% Made in Italy. Due semplici forme, un cerchio e un cono, accostate fra loro, a richiamare quest'albero simbolico, padrone del paesaggio. La solida base che li caratterizza può essere personalizzata in laccato bianco perla, grigio quarzo e blu oceano, con top nero rame perla.

Coffee-tables entirely made of ceramic, 100% Made in Italy craftsmanship. Two simple shapes, a circle and a cone, side by side, to recall this symbolic tree, master of the landscape. The solid base that characterizes them can be customized in oyster white, quartz grey and ocean blue lacquer, with pearl black copper top.

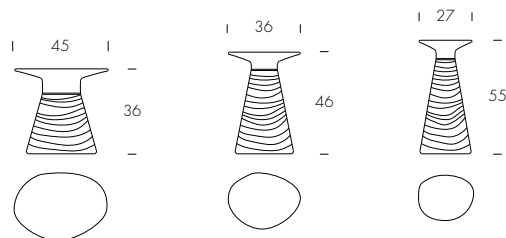

Baobab  
top nero perla/pearl black top (V168);  
struttura bianco perla, grigio quarzo e blu oceano/  
oyster white, quartz grey and ocean blue structure (101, 129, 112).



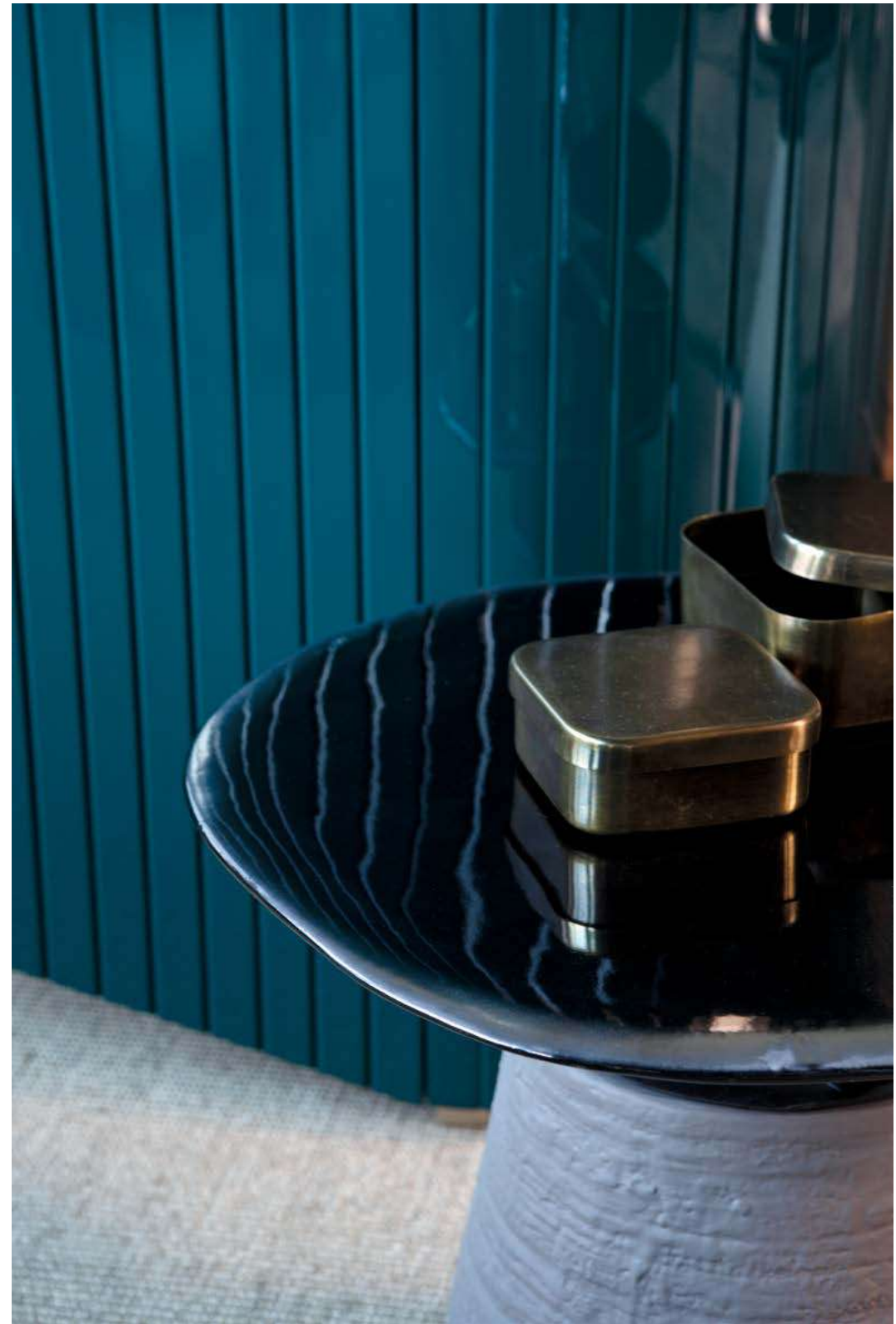



# bloom

Opaca Lab

I tavolini Bloom, dalla solida base in acciaio verniciato, sono caratterizzati da un elegante e ampio top in gres porcellanato. Decorano con gusto ogni contesto abitativo, coniugando funzionalità e stile.

The Bloom coffee tables, with a solid painted steel base, are characterized by an elegant and large porcelain stoneware top. They tastefully decorate every living context, combining functionality and style.

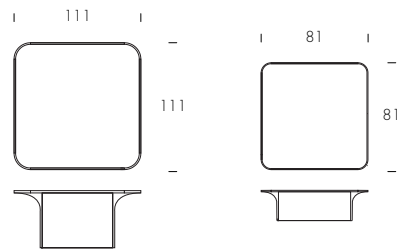

Base **bronzo pietra** - top gres porcellanato **Onice Grigio**  
Stone bronze base - Onyx Grey porcelain top



Base **bronzo pietra** - top gres porcellanato **Statuario Altissimo**  
Stone bronze base - Statuario Altissimo porcelain top



Base **grigio carbone** - top gres porcellanato **Onice Grigio**  
Carbon grey base - Onyx grey porcelain top



Base **grigio carbone** - top gres porcellanato **Statuario Altissimo**  
Carbon grey base - Statuario Altissimo porcelain top





Baobab  
struttura titanio e grigio carbone / titanium and carbon grey structure (34, 10);  
top gres Crème lucida e opaco / shiny and matt Crème porcelain top (V90P, V91P).





# bridge

Plurimo Design

La scrivania direzionale Bridge dalle ampie dimensioni è impreziosita dal top in porcellanato e dalle eleganti finiture in bronzo e oro satinato. Il piano dal profilo morbido e dalla geometria sottile dai bordi smussati offre un appoggio confortevole a chi lavora. La base di Bridge richiama nel nome il suo design evocativo e comunica apertura e dialogo, invitando alla condivisione. Bridge è allestito con cassetto laterale e dotato sul lato esterno di un pratico vano portaoggetti.

The large-sized Bridge executive desk is embellished with a porcelain top and elegant bronze and satin gold finishes. The top with a soft profile and a thin geometry with rounded edges offers a comfortable support to those who work. The base of Bridge recalls its evocative design in the name and communicates openness and dialogue, inviting sharing. Bridge is fitted with side drawer and equipped on the outside with a practical storage compartment.

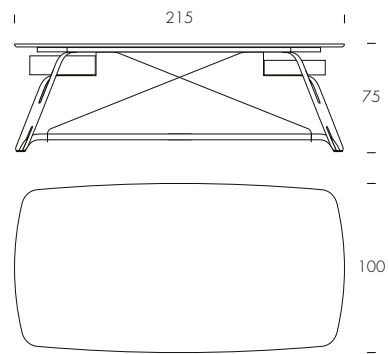



**Bridge**

struttura bronzo pietra/stone bronze structure (83);  
inserto e cassetto noce Canaletto/Canaletto walnut insert and drawer (14);  
top gres Crème lucido/shiny Crème porcelain top (V90P).





# catullo

Federica Romualdi

Il cesto in cuoio Catullo è versatile e funzionale: un elegante complemento d'arredo per accogliere riviste, appoggiare una coperta o riporre a piacere qualunque oggetto da avere vicino. Questo cesto portatutto dalla comoda capienza è reso ancor più prezioso dai bottoni alle maniglie e dagli inserti in oro satinato che ne denotano l'alta artigianalità.

The Catullo thick leather basket is versatile and functional: an elegant piece of furniture for holding magazines, placing a blanket or storing any object you want nearby. This handy storage basket is made even more precious by the buttons on the handles and the satin gold inserts that denote its high craftsmanship.

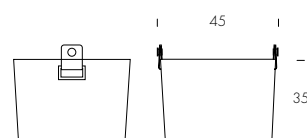

Catullo  
rivestimento cuoio cognac/cognac thick leather covering (K59).





# classic

Tonin Casa Creatives

Tavolino dalla linea sinuosa e minimal, in finitura extrachiaro, bronzo o fumè.  
Disponibile in tre misure.

Sinuous and minimal coffee-table, in extra-clear, bronzed or fumè finish.  
Available in three different sizes.

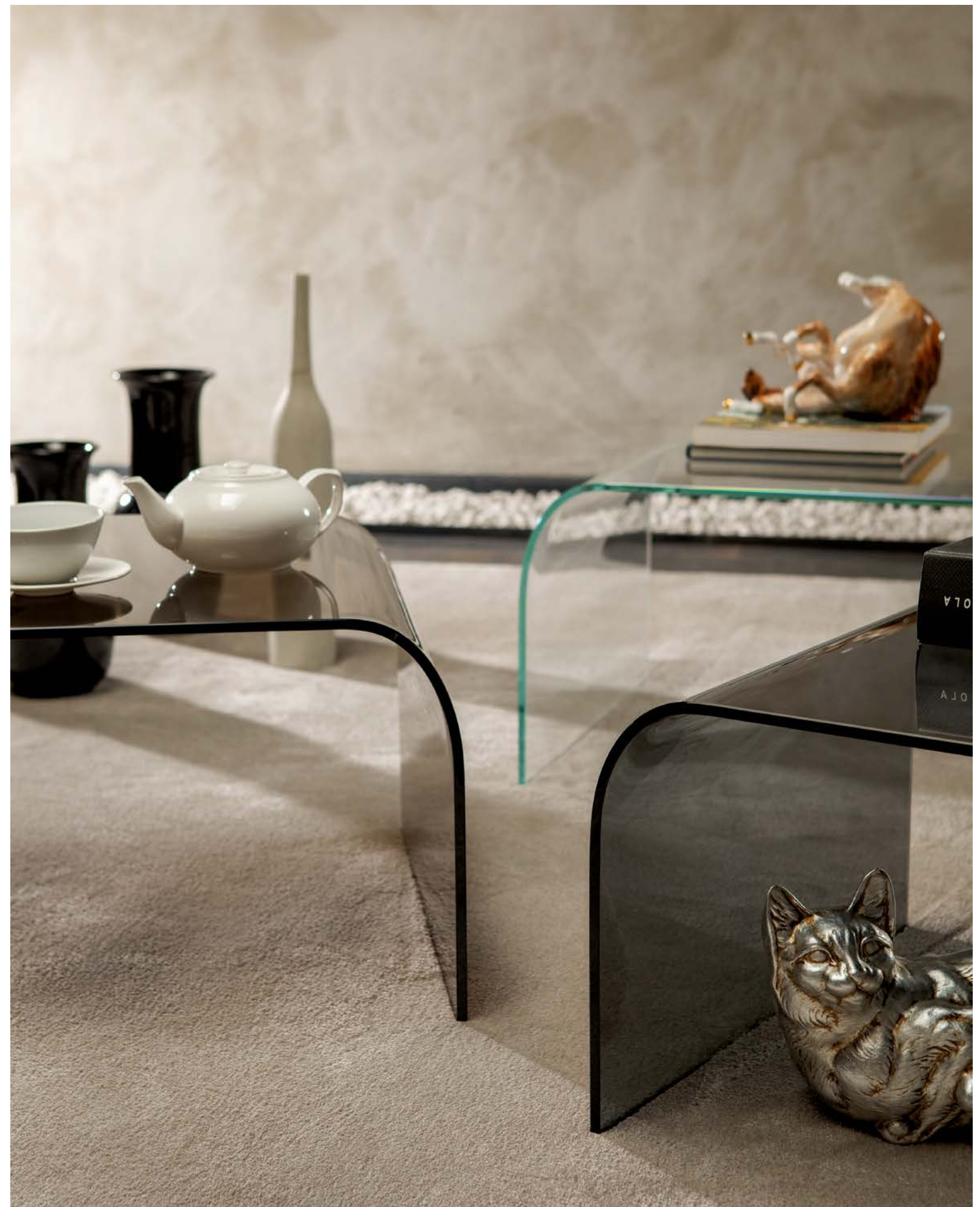
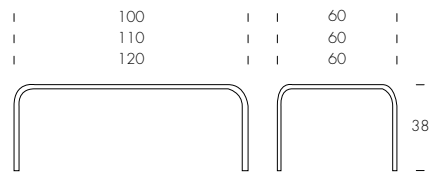



Classic  
struttura vetro extrachiaro trasparente, bronzo trasparente e fumè trasparente/  
transparent extra-clear, fumè and bronze glass structure (V100, V84, V85).





# classic big

Tonin Casa Creatives

Tavolino dalla linea sinuosa e minimal, con ripiano in finitura extrachiaro, bronzo o fumè.

Sinuous and minimal coffee-table, with shelf in extra-clear, bronze or fumè finish.

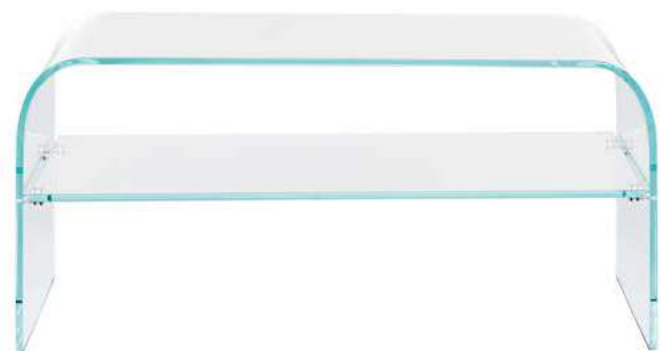
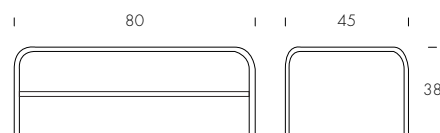

Classic Big  
struttura vetro fumè trasparente/  
transparent fumè glass structure (V85).



# cosmo

Tosca Design

L'eleganza e l'armonia delle forme pure caratterizzano il tavolino Cosmo, composto da tre top in vetro con bottone centrale in oro satinato e base in legno massello. Le diverse altezze dei tre piani ne esaltano l'estetica potente.

The elegance and harmony of pure forms characterize the Cosmo coffee table, consisting of three glass tops with a central satin gold button and solid wood base. The different heights of the three tops enhance its powerful aesthetics.

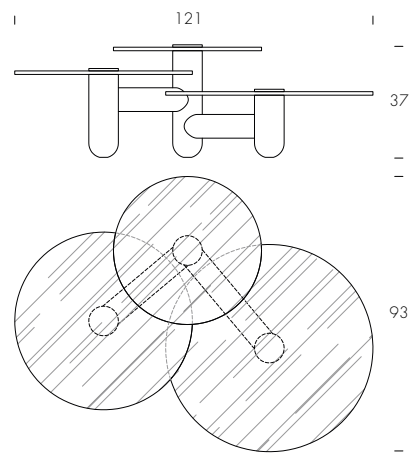

Cosmo  
struttura frassino nero/black ash structure (25);  
top vetro fumè/fumè glass top (V85).

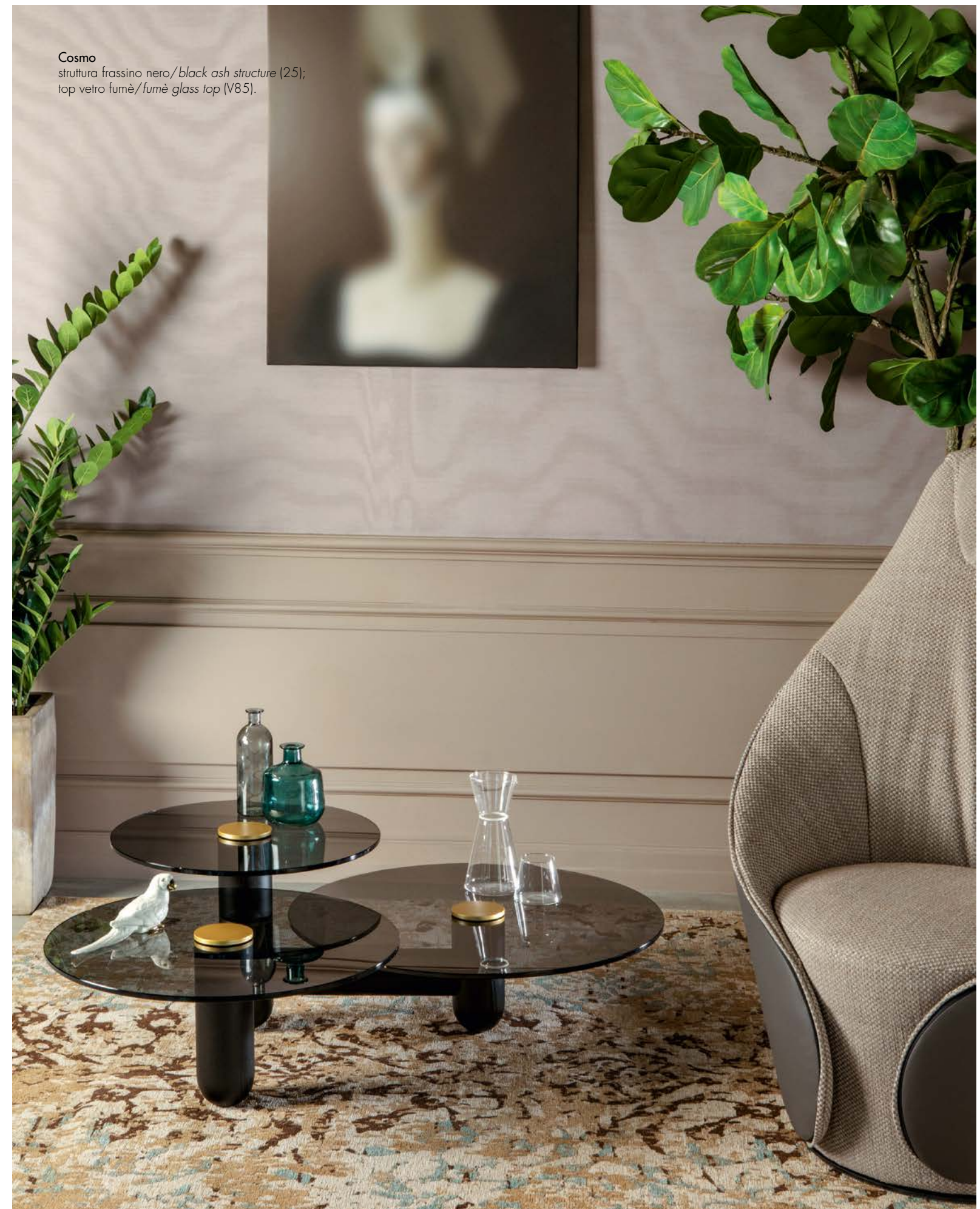







# dedalo

Tonin Casa Creatives

Tavolini Dedalo in vetro trasparente, extrachiaro, bronzo e fumè con base specchiante abbinata alla struttura.  
Il nome, che riprende l'ideatore del famoso labirinto cretese nel mito greco, è un chiaro riferimento al suo particolare design.

Dedalo coffee-tables in transparent, extra-clear, bronze and fumè glass with mirror base combined with the structure.  
The name, which takes up the creator of the famous Cretan labyrinth in the Greek myth, is a clear reference to its particular design.

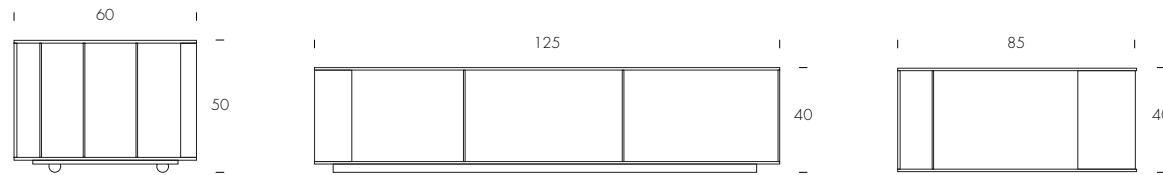

Dedalo  
struttura vetro bronzo trasparente e specchio bronzato/  
transparent bronze glass and bronzed mirror structure (V84, V184).





# dot

M. Mottin | E. Barbieri

Come la madia già presente nella collezione, Dot è disponibile anche nella versione tavolino minimal chic che prende posto in ambienti senza tempo. Il top rotondo è caratterizzato dal gres porcellanato con una cornice in legno. La struttura in metallo verniciato rende questi tavolini essenziali e di grande valore estetico.

Like the sideboard already present in the collection, Dot is also available in the minimal chic coffee-table version that takes its place in timeless environments. The frame top is characterized by porcelain stoneware with a wooden frame. The painted metal structure makes these tables essential and of great aesthetic value.

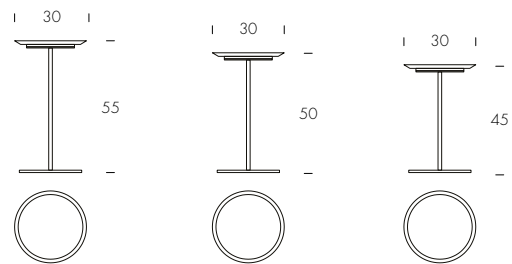

Dot  
struttura titanio e grigio carbone / titanium and carbon grey structure (34, 10);  
ring frassino nero / black ash ring (25);  
top gres Statuario Altissimo / Statuario Altissimo porcelain top (VO1P).





# fidelio

Mottin M. | Barbieri E.

I tavolini Fidelio, con base in legno e top in gres porcellanato, catturano per la pienezza scultorea delle forme e la magnificenza del legno massello. Sono disponibili in quattro diverse dimensioni e finiture.

Fidelio coffee-tables, with wooden base and porcelain stoneware top, capture for the solid wood sculptural fullness and magnificence. They are available in four different sizes and finishes.

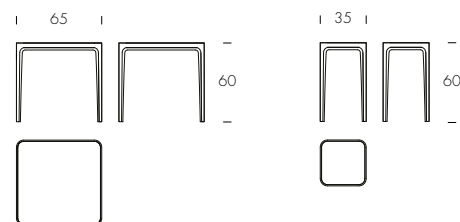
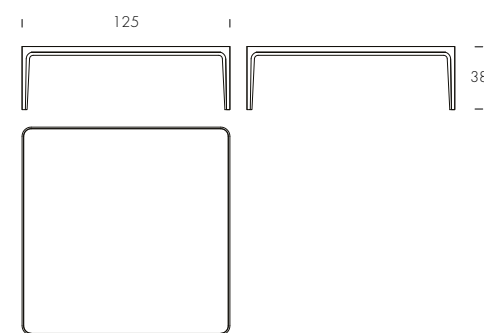
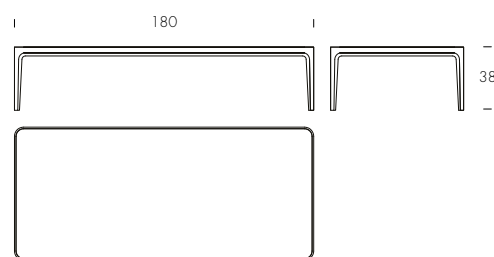

Fidelio  
struttura frassino nero/black ash structure (2.5);  
top gres Portoro/Portoro porcelain top (V85P).





# flow

Tonin Casa Creatives

Il design che caratterizza questo tavolino richiama un flusso, simile al movimento di un'onda. Disponibile in finitura extrachiaro o fumè.

The design that characterizes this table recalls a flow similar to the movement of a wave. Available in extra-clear or fumè finish.

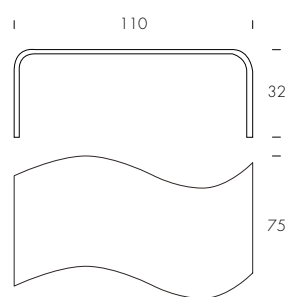

Flow  
struttura vetro extrachiaro trasparente/  
transparent extra-clear glass structure (V100).



# ginco

Cristian Dal Bianco

Questi tavolini ispirati alla natura sono formati da una struttura tubolare leggera e da un top a forma di ventaglio, che ricorda la foglia del Ginkgo. Armonici anche accostati l'uno all'altro, spiccano per l'elegante particolarità del loro design.

These coffee-tables inspired by nature are made up of a light tubular structure and a fan-shaped top reminiscent of the Ginkgo leaf. Harmonious even when placed side by side, stand out for the elegant peculiarity of its design.

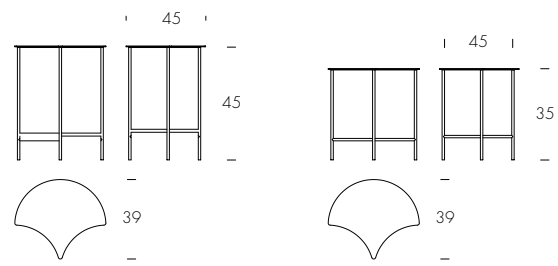

**Ginco**  
struttura titanio/*titanium structure* (34);  
top gres Statuario Altissimo/  
*Statuario Altissimo porcelain top* (V01P).



# jazz

LM Design

Da' alla tua casa una nuova prospettiva glam con la serie di tavolini Jazz in due misure e varie finiture: servetto e tavolino con top in vetro o vetro martellato e base in metallo verniciato.

Give your home a new glam perspective with the Jazz coffee table series in two sizes and various finishes: side table and coffee table with glass or hammered glass top and varnished metal base.

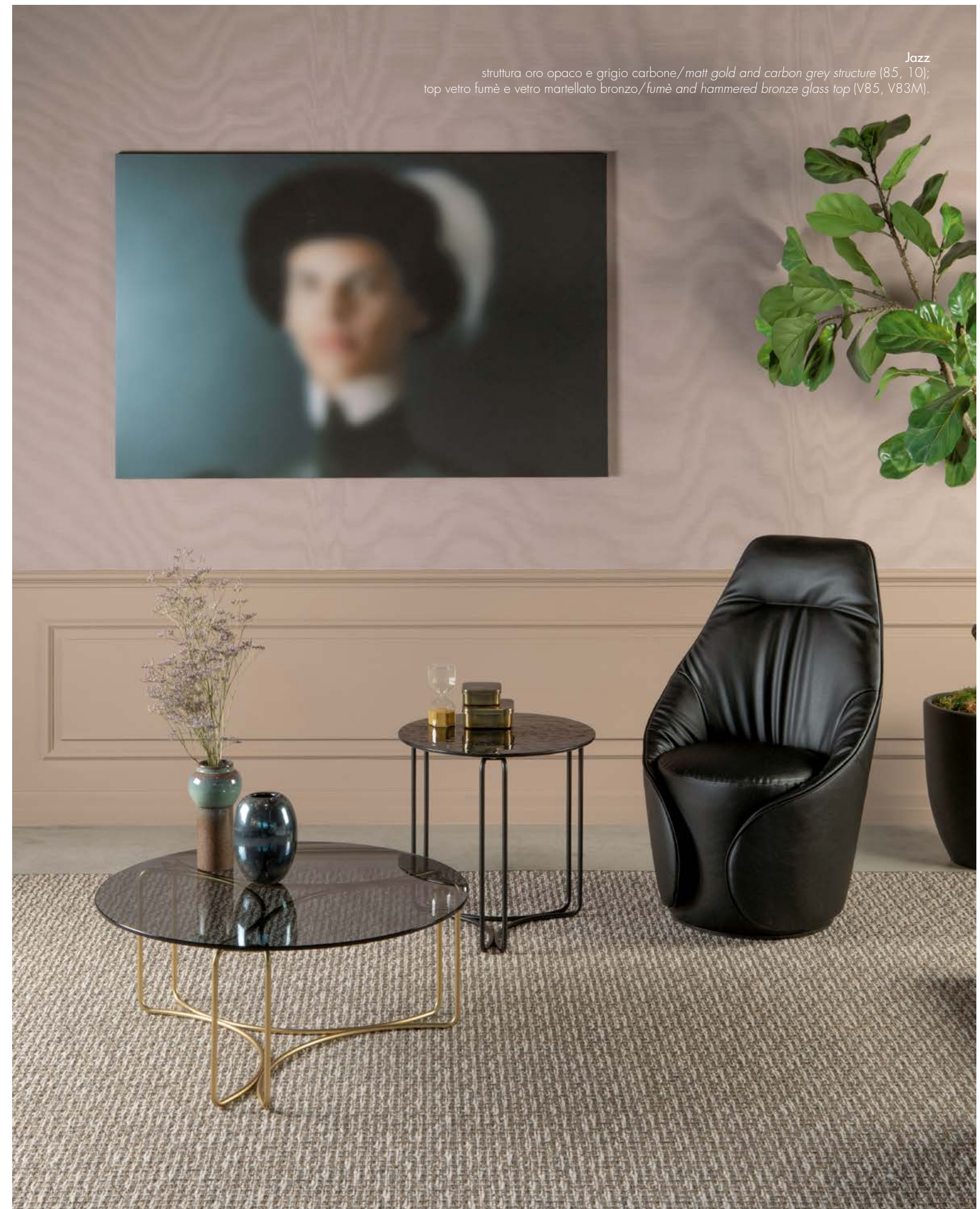
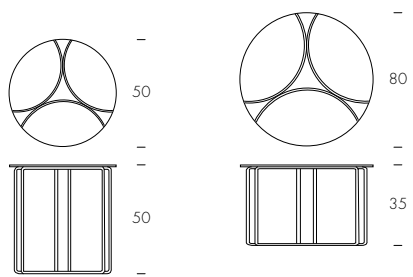

Jazz  
struttura oro opaco e grigio carbone/matt gold and carbon grey structure (85, 10);  
top vetro fumè e vetro martellato bronzo/fumè and hammered bronze glass top (V85, V83M).







# ledor

Tosca Design

Lo scrittoio ledor unisce alla solida struttura in legno con finitura noce canaletto o frassino nero, il raffinato rialzo del top in cuoio: il risultato è una scrivania di grande effetto, adatta ad ogni ambiente.

The Ledor desk combines the solid wooden structure in Canaletto walnut or black ash finish, with the refined rise of the thick-leather top: the result is a highly effective desk, suitable for any environment.

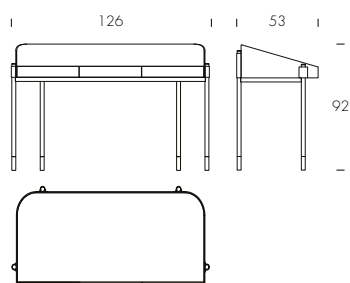

Ledor  
struttura cuoio nero/black thick leather structure (K73);  
top noce Canaletto/Canaletto walnut top (14).







Ledor  
struttura cuoio nero, cognac, beige e ottanio/  
black, cognac, beige and oil-blue thick leather structure (K73, K59, K102, K34);  
top noce Canaletto e frassino nero/Canaletto walnut and black ash top (14, 25).



# levels

Cristian Dal Bianco

Il tavolino Levels è caratterizzato da una struttura tubolare ad U e dalla diversa altezza dei due piani di appoggio. I top sono disponibili nella stessa finitura della base oppure nella versione con i piani in gres porcellanato.

The Levels coffee-table is characterized by a U-shaped tubular structure and by the different height of the two support surfaces. The tops are available in the same finish as the base or in the version with porcelain stoneware tops.

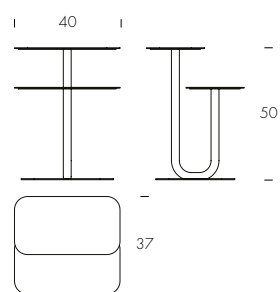

## Levels

struttura grigio carbone/ carbon grey structure (10);  
top gres Statuario Altissimo/ Statuario Altissimo porcelain top (VO1P).





# libellula

Angelo Tomaiuolo

Questo appendiabiti richiama la forma e la sinuosità delicata e leggiadra delle ali di una libellula, per creare un elemento d'arredo estremamente elegante e unico.

This coat-hanger recalls the delicate and graceful shape and sinuosity of the wings of a dragonfly, to create an extremely elegant and unique furnishing element.

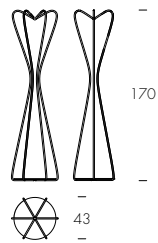

## Libellula

struttura bronzo pietra e titanio / stone bronze and titanium structure (83, 34).





# line

Tonin Casa Creatives

Una linea continua che disegna un tavolino lineare e un funzionale portariviste di design in vetro extrachiaro o fumè.

A continuous line that draws a linear table and a functional design magazine rack in extra-clear or fumè glass.

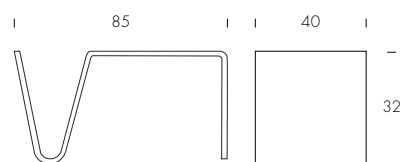

Line  
struttura vetro fumè trasparente/fumè transparent structure (V85).



# madame

Federica Romualdi

Materiali di alta qualità e artigianato più pregiato si uniscono nei cesti in cuoio Madame, impreziositi da un ampio manico lavorato a mano in legno termocurvato e disponibili in calde tonalità.

High quality materials and the finest craftsmanship come together in the Madame leather baskets, embellished with a large hand-crafted handle in thermo-curved wood and available in warm shades.

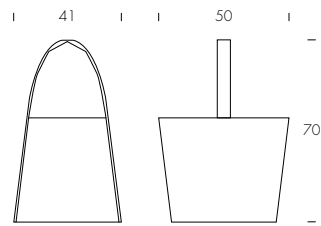

## Madame

maniglia noce Canaletto, frassino nero/Canaletto walnut, black ash handle (14, 25);  
rivestimento cuoio testa di moro, beige/dark brown, beige thick leather covering (K91, K102).





# mirò

Angelo Tomaiuolo

Questo servomuto che prende ispirazione dall'artista Mirò, richiama atmosfere surreali. Funzionale e al contempo prezioso, è realizzato con finiture in legno massello e acciaio verniciato.

This valet stand, inspired by the artist Mirò, recalls surreal atmospheres. Functional and at the same time precious, it is made with solid wood and painted steel finishes.

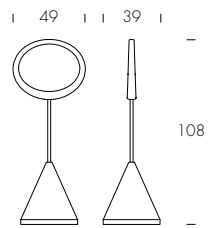

Mirò  
struttura titanio/titanium structure (34);  
anello rovere scuro/dark oak ring (16).



# modi

Angelo Tomaiuolo

Due tavolini e un servetto dalla struttura sinuosa, in acciaio verniciato con un elegante top in gres porcellanato.

Two small tables and a side table with a sinuous structure, in painted steel with an elegant porcelain stoneware top.

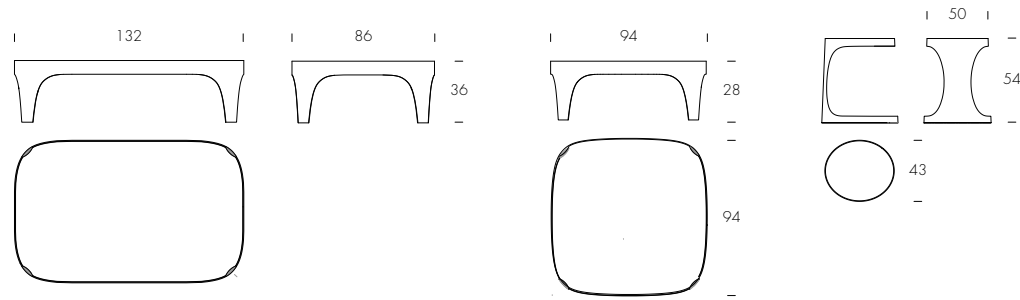

Modi  
struttura grigio carbone / carbon grey structure (10);  
top gres Portoro / Portoro porcelain top (V85P).





Modi  
struttura bronzo pietra e oro opaco / stone bronze and matt gold structure (83, 85);  
top gres Crème opaco e Terra Liquida / matt Crème and Terra Liquida porcelain top (V91P, V92P).











# oblò

Plurimo Design

Con il suo design originale il carrello portavivande Oblò comprende bellezza e funzionalità: una soluzione versatile che si adatta a qualsiasi esigenza, un complemento must per la cucina o la zona giorno. Composto da due top circolari in legno e struttura in metallo.

With its original design, the Oblò food trolley includes beauty and functionality: a versatile solution that adapts to any need, a must-have accessory for the kitchen or living area. Composed of two circular wooden tops and metal structure.

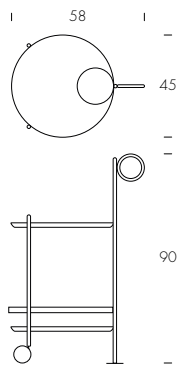



# opus

Tonin Casa Creatives

Opus è il servetto multifunzione dal design distintivo, che fonde eleganza funzionale e stile. Realizzato con struttura in metallo verniciato con finitura bronzo, Opus è caratterizzato da un'esclusiva tasca laterale in cuoio cognac.

Opus is the multifunctional side table with a distinctive design, which blends functional elegance and style. Made with a painted metal structure with a bronze finish, Opus is characterized by an exclusive side pocket in cognac thick leather.

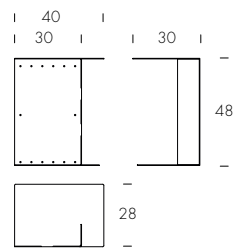

Opus  
struttura bronzo pietra/stone bronze structure (83);  
cuoio cognac/cognac thick leather (K59).



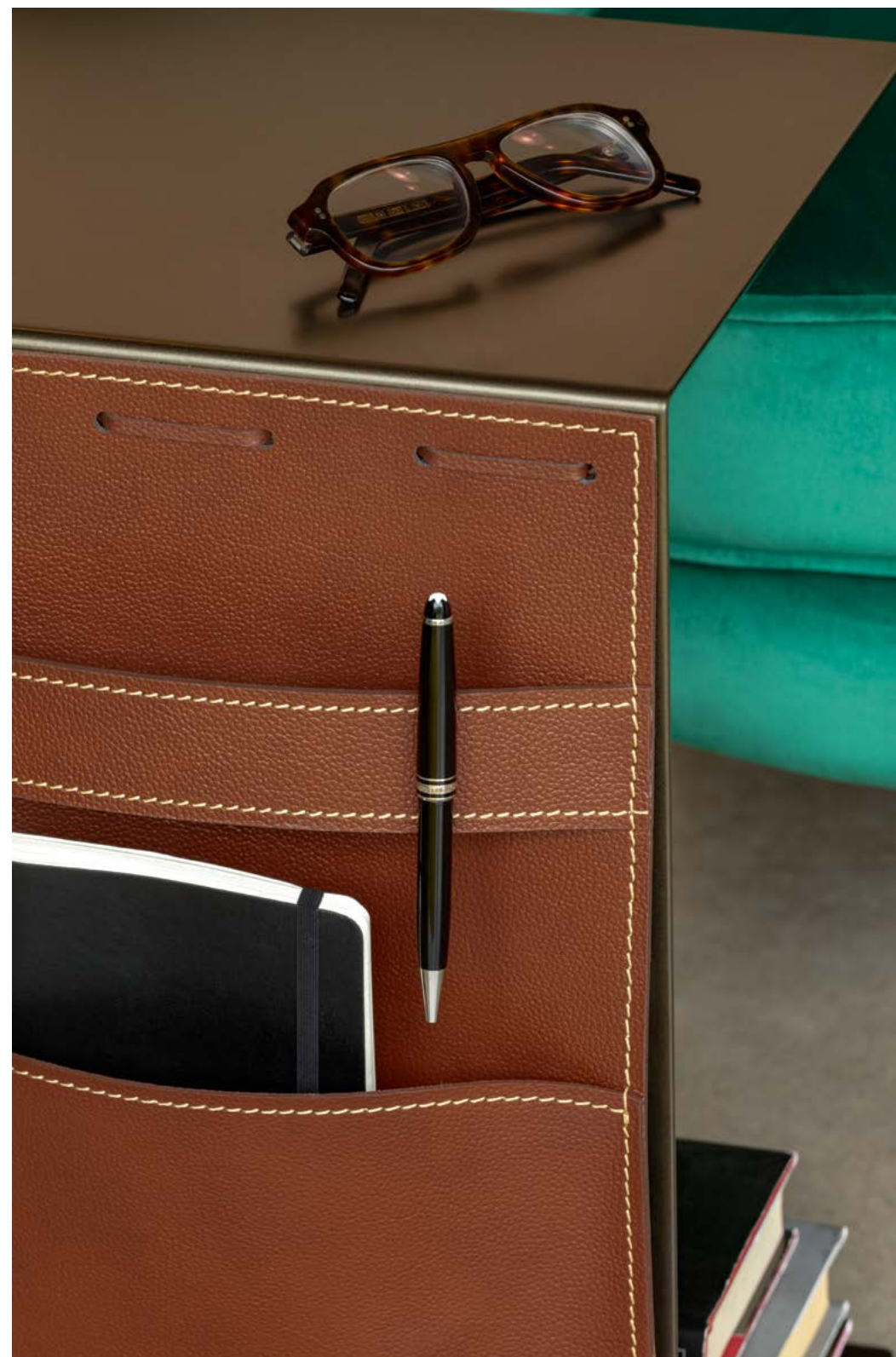



# pacman

Tonin Casa Creatives

La combinazione tra la curvatura e l'incollaggio delle componenti di questi tavolini in cristallo creano un angolo che esalta l'estetica delle forme tondeggianti: linee contrastanti che diventano armonica espressione di coesistenza e danno nuove opportunità per creare accostamenti esclusivi.

The combination between the curvature and the gluing of the components of these crystal tables create an angle that enhances the aesthetic of the rounded shapes: contrasting lines that become a harmonious expression of coexistence that give new opportunities to create exclusive combinations.

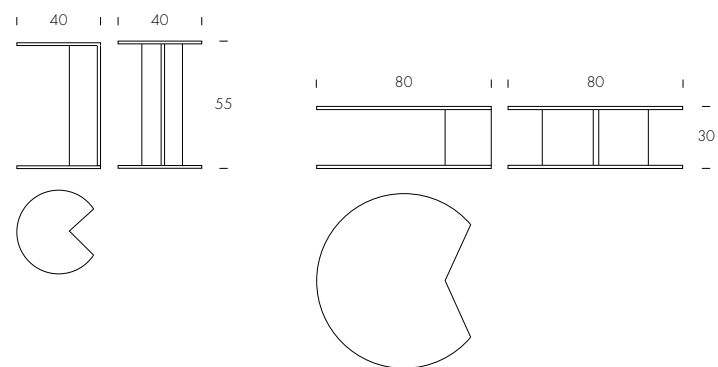



# palmbeach

Plurimo Design

Una combinazione unica di texture, colori e design: nasce Palmbeach, una nuova versatile famiglia di tavolini in ceramica matt abbinata a smalti lucidi o finiture pregiate in oro lucido. Due forme inconfondibili dalla forte personalità per tavolino e servetto, disponibili anche con diffusore di luce e in varie misure con base finitura matt e top lucido.

A unique combination of textures, colors and design: Palmbeach is born, a new versatile family of matt ceramic coffee tables combined with glossy enamels or precious glossy gold finishes. Two unmistakable shapes with a strong personality for coffee table and side table, also available with light diffuser and in various sizes with matt finish base and glossy top.

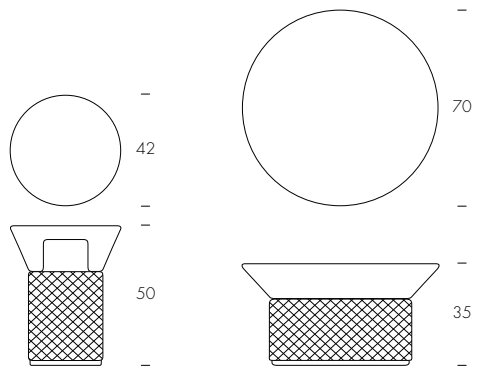

Palmbeach  
struttura oro lucido e nero opaco/shiny gold and matt black structure.



Palmbeach  
struttura lucido e opaco blu oceano, bianco perla, giallo senape/  
ocean blue, oyster white, mustard yellow shiny and matt structure.





# papillon

G. Codato | L. Trevisiol

Un elegante fiocco dalle linee simmetriche, espressione di eleganza per eccellenza: è Papillon, mensola e appendiabiti da parete, che declina la sua doppia funzionalità, donando immediato carattere ad ogni ambiente.

An elegant bow with symmetrical lines, an expression of elegance par excellence: it is Papillon, wall shelf and coat-hanger, which declines its double functionality, giving immediate character to any environment.

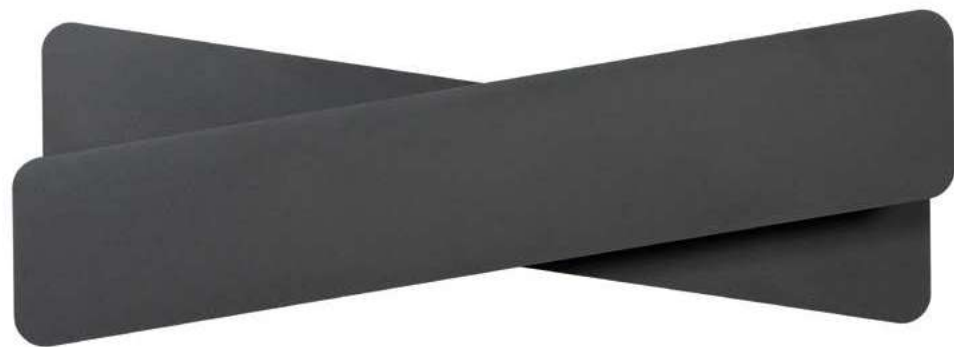
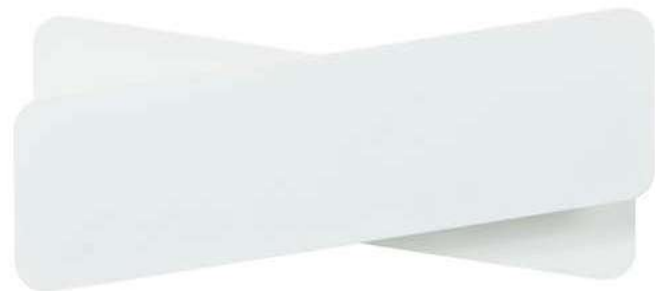
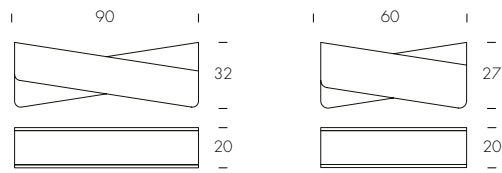

Papillon  
struttura bianco opaco e grigio carbone/  
matt white and carbon grey structure (01, 10).



# rendez-vous

Plurimo Design

Orologio bombato in ceramica con due tubolari in acciaio verniciato. Finitura nero matt intenso e oro in foglio per questo elemento d'arredo dal carattere deciso.

Ceramic convex clock with two painted steel tubes. Intense matt black and gold leaf finish for this piece of furniture with a strong character.

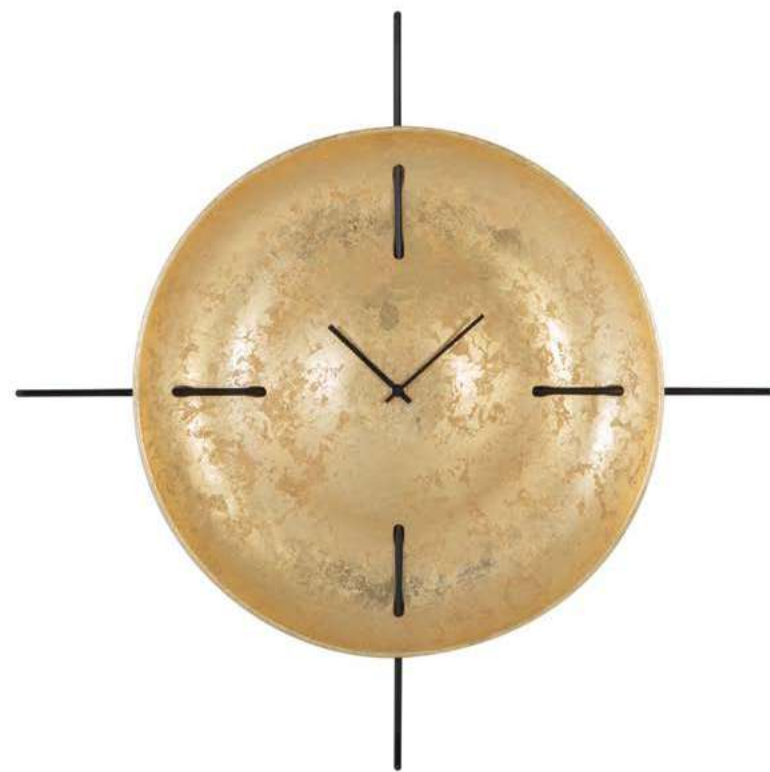
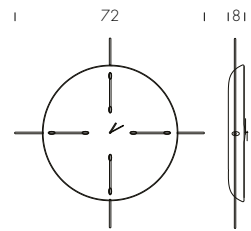

Rendez-vous  
struttura ceramica moka opaco/matt moka ceramic structure (A).



# rim

Tonin Casa Creatives

Rim, un trittico di tavolini sovrapponibili dalla struttura in metallo e disponibili anche con l'aggiunta dei top in gres porcellanato.

Rim, a triptych of stackable coffee-tables with a metal structure and also available with the addition of porcelain stoneware tops.

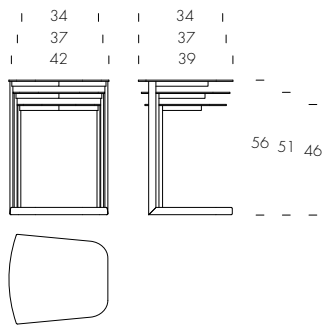

Rim  
struttura brushed rame/brushed copper structure (SP98).



Rim  
struttura grigio carbone / carbon grey structure (10);  
top gres onice grigio / onyx grey porcelain top (V73P).





# roller

Artefatto Studio Design

I tavolini Roller sono formati da una curvatura del legno e da un piano in gres porcellanato, impreziosito da un ring con finitura ottone.

Roller tables are formed by a curvature of the wood and a porcelain stoneware, top embellished with a ring characterized by a brass finish.

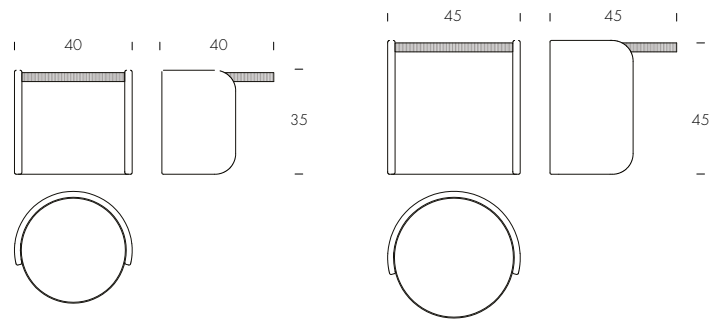









**Roller**  
struttura noce Canaletto/*Canaletto walnut structure* (14);  
top gres Statuario Altissimo/*Statuario Altissimo porcelain top* (VO1P).





# ryazka

Tanya Repina & Misha Repin

Tavolini Ryazka, con top a forma di trifoglio. Vincitori del concorso Elle Decor Russia per la loro linea contemporanea e dal grande valore estetico che richiama questo elemento naturale.

Ryazka coffee-tables, with a clover-shaped top. Winners of the Elle Decor Russia competition for its contemporary line and great aesthetic value that recalls this natural element.

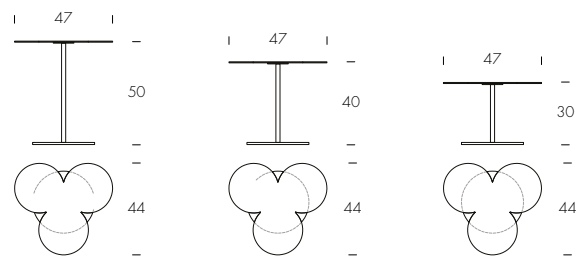

Ryazka  
struttura brushed bronzo/  
brushed bronze structure (SP83).





# sinergy

Artefatto Studio Design

Un gioco geometrico dal temperamento forte e deciso, Sinergy è l'unione di due tavolini complementari. In metallo e gres porcellanato, questi tavolini sono in perfetta sinergia con qualsiasi ambiente.

A geometric game with a strong and decisive temperament, Sinergy is the union of two complementary tables. In metal and porcelain stoneware, these tables are in perfect synergy with any environment.

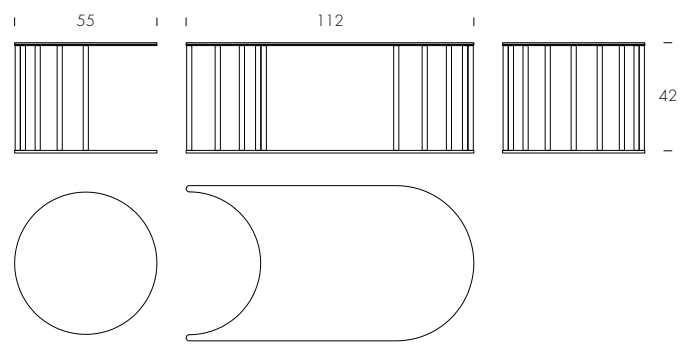

Sinergy  
struttura bronzo pietra/ stone bronze structure (83);  
top gres Emperador/Emperador porcelain top (V83P).



Sinergy  
struttura bronzo pietra/ stone bronze structure (83);  
top gres Terra Liquida, Agata black, Macchiavecchia opaco/  
Terra Liquida, Agata black, matt Macchiavecchia porcelain top (V92P, V95P, V88P).





# snowboards

Plurimo Design

Snowboards sono le nuove mensole Tonin Casa con varie finiture in laccato, ceramica e legno. Questi ripiani dallo stile unico e dal design particolare arredano in modo originale le pareti.

Snowboards are the new Tonin Casa shelves with various finishes in lacquer, ceramic and wood. These shelves with a unique style and a particular design furnish the walls in an original way.

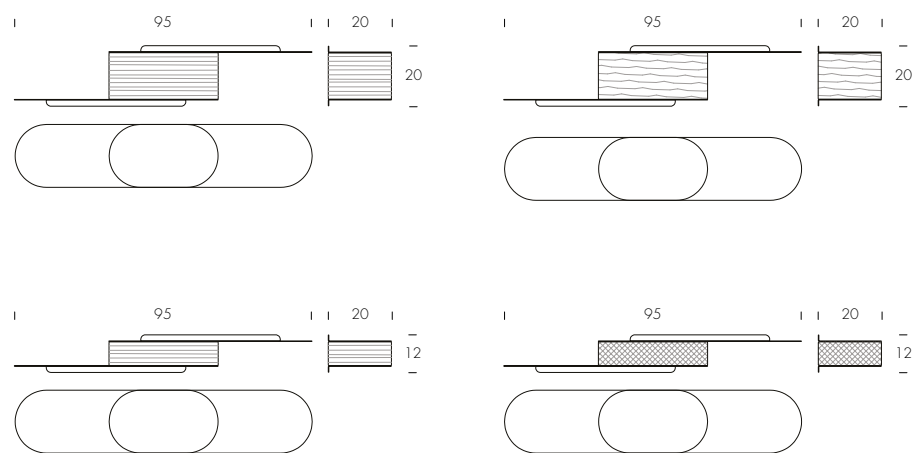

Snowboards  
struttura bronzo pietra/ stone bronze structure (83);  
inserto ceramica bianca con onde, ceramica bianca con borchie, ceramica nera con borchie/  
white ceramic with waves, white ceramic with studs, black ceramic with studs insert (CM01, CM02).

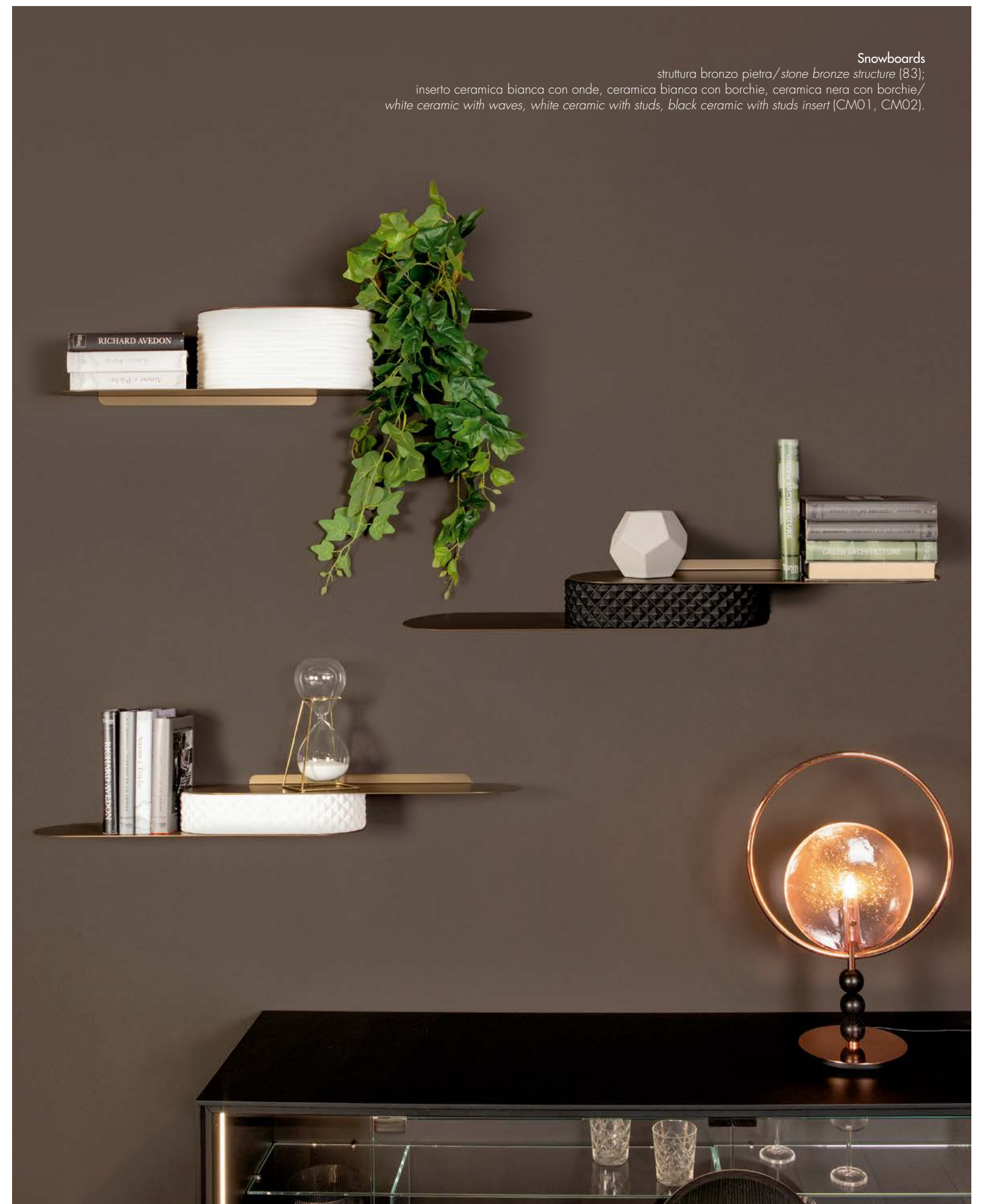



Snowboards

struttura bianco opaco, nero opaco/matt white, matt black structure (01, 02);  
inserto noce Canaletto, rovere scuro/noce Canaletto, dark oak insert (14, 16).





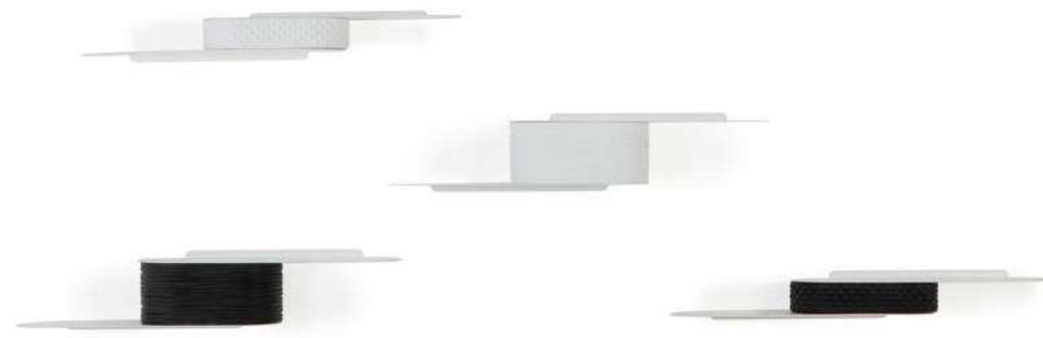

- Mensola bianco opaco*
- inserto basso *ceramica bianca con borchie*
  - inserto alto *ceramica bianca con onde*
  - inserto basso *ceramica nera con borchie*
  - inserto alto *ceramica nera con onde*

- Matt white shelf*
- white ceramic with studs low insert
  - white ceramic with waves high insert
  - black ceramic with studs low insert
  - black ceramic with waves high insert

- Mensola nero opaco*
- inserto basso *ceramica bianca con borchie*
  - inserto alto *ceramica bianca con onde*
  - inserto basso *ceramica nera con borchie*
  - inserto alto *ceramica nera con onde*

- Matt black shelf*
- white ceramic with studs low insert
  - white ceramic with waves high insert
  - black ceramic with studs low insert
  - black ceramic with waves high insert

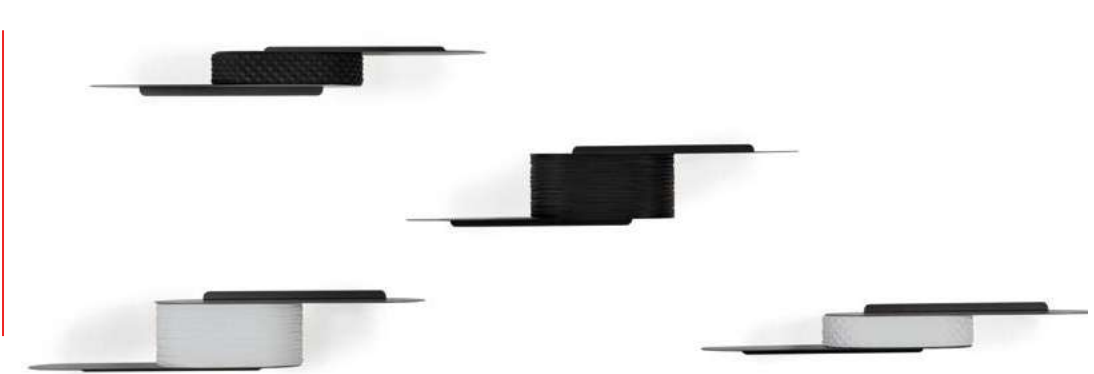

- Mensola bianco opaco*
- inserto basso *frassino nero*
  - inserto alto *frassino nero*
  - inserto basso *noce Canaletto*
  - inserto alto *noce Canaletto*

- Matt white shelf*
- black ash low insert
  - black ash high insert
  - Canaletto walnut low insert
  - Canaletto walnut high insert

- Mensola nero opaco*
- inserto basso *frassino nero*
  - inserto alto *frassino nero*
  - inserto basso *noce Canaletto*
  - inserto alto *noce Canaletto*

- Matt black shelf*
- black ash low insert
  - black ash high insert
  - Canaletto walnut low insert
  - Canaletto walnut high insert

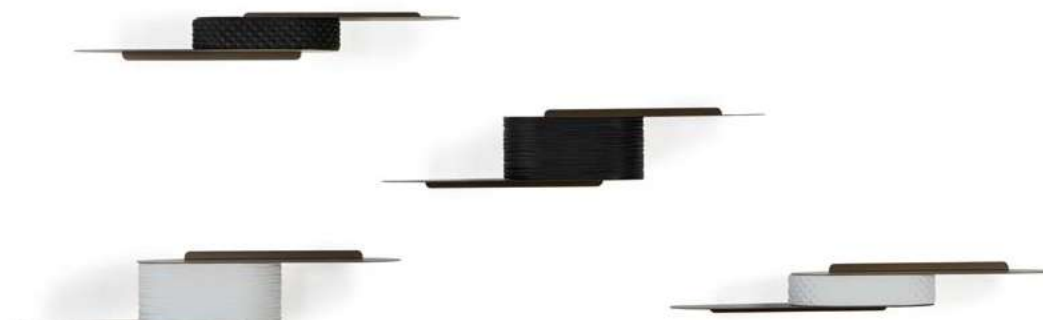

- Mensola bronzo pietra*
- inserto basso *ceramica bianca con borchie*
  - inserto alto *ceramica bianca con onde*
  - inserto basso *ceramica nera con borchie*
  - inserto alto *ceramica nera con onde*

- Stone bronze shelf*
- white ceramic with studs low insert
  - white ceramic with waves high insert
  - black ceramic with studs low insert
  - black ceramic with waves high insert

- Mensola bronzo pietra*
- inserto basso *frassino nero*
  - inserto alto *frassino nero*
  - inserto basso *noce Canaletto*
  - inserto alto *noce Canaletto*

- Stone bronze shelf*
- black ash low insert
  - black ash high insert
  - Canaletto walnut low insert
  - Canaletto walnut high insert





# surf

Studio Archirivolto

Preziosa artigianalità e tecnologia innovativa sono il connubio che caratterizza lo scrittoio Surf, con caricabatterie wireless integrato nella superficie, che rende possibile caricare il cellulare appoggiandolo sullo scrittoio.

Surf, dalla distintiva linea dinamica che rievoca un'onda, è rivestito in cuoio e dotato di luce dimmerabile per regolare l'intensità del fascio luminoso. Inoltre l'ampio piano per pc, libri o notebook, rende questo scrittoio un alleato ideale anche per tutte le necessità di homeworking, coniugando funzionalità e stile, a casa come in ufficio.

Precious craftsmanship and innovative technology are the combination that characterizes the Surf desk, with wireless charger integrated into the surface, which makes it possible to charge the mobile phone by placing it on the desk. Surf, with a distinctive dynamic line that evokes a wave, is covered in thick leather and equipped with dimmable light to adjust the intensity of the light beam. In addition, the large top for PCs, books or notebooks makes this desk an ideal side table for all homeworking needs, combining functionality and style, at home as well as in the office.

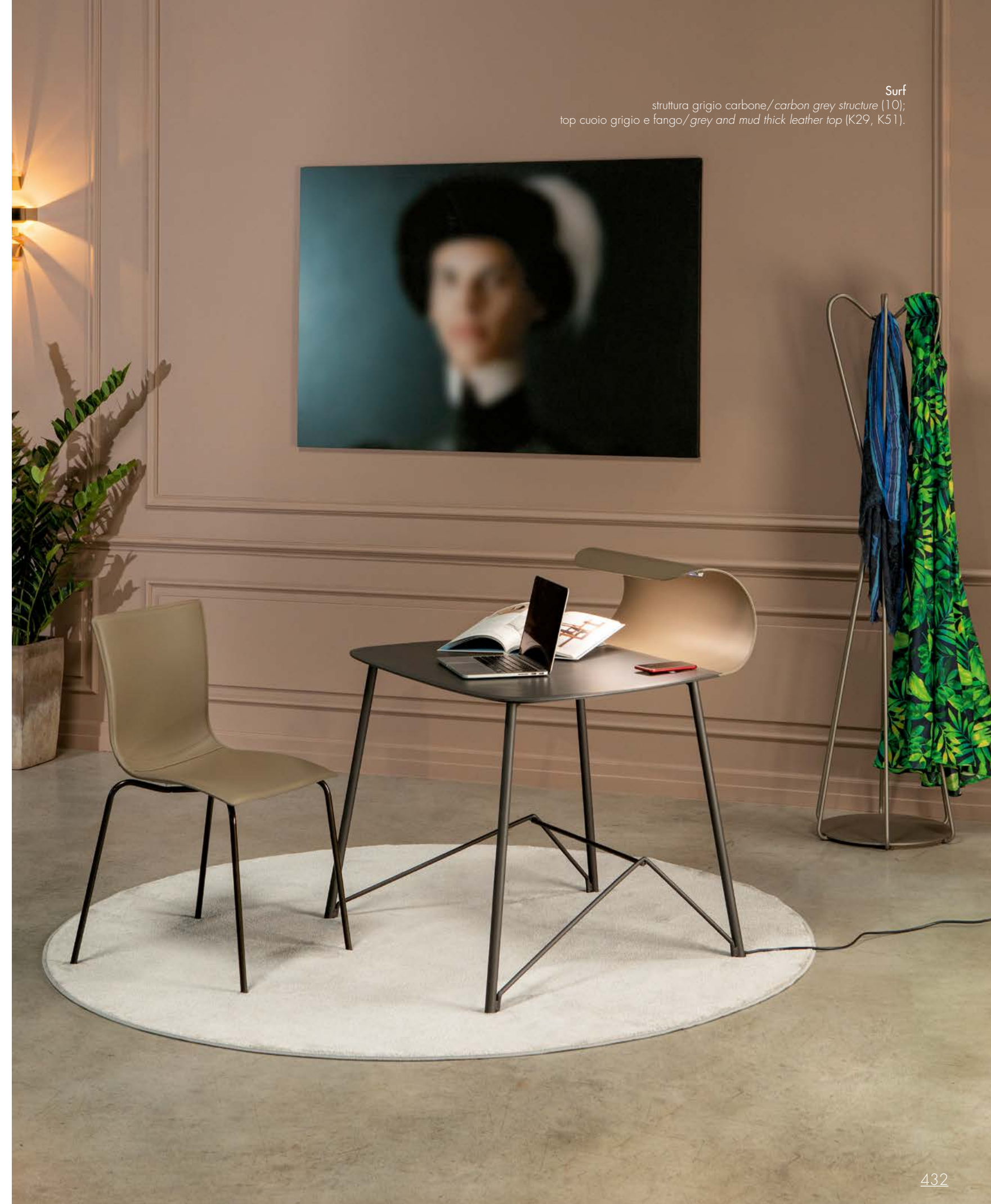
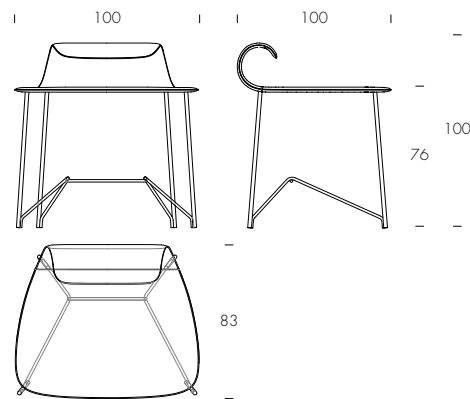

Surf  
struttura grigio carbone/carbon grey structure (10);  
top cuoio grigio e fango/grey and mud thick leather top (K29, K51).



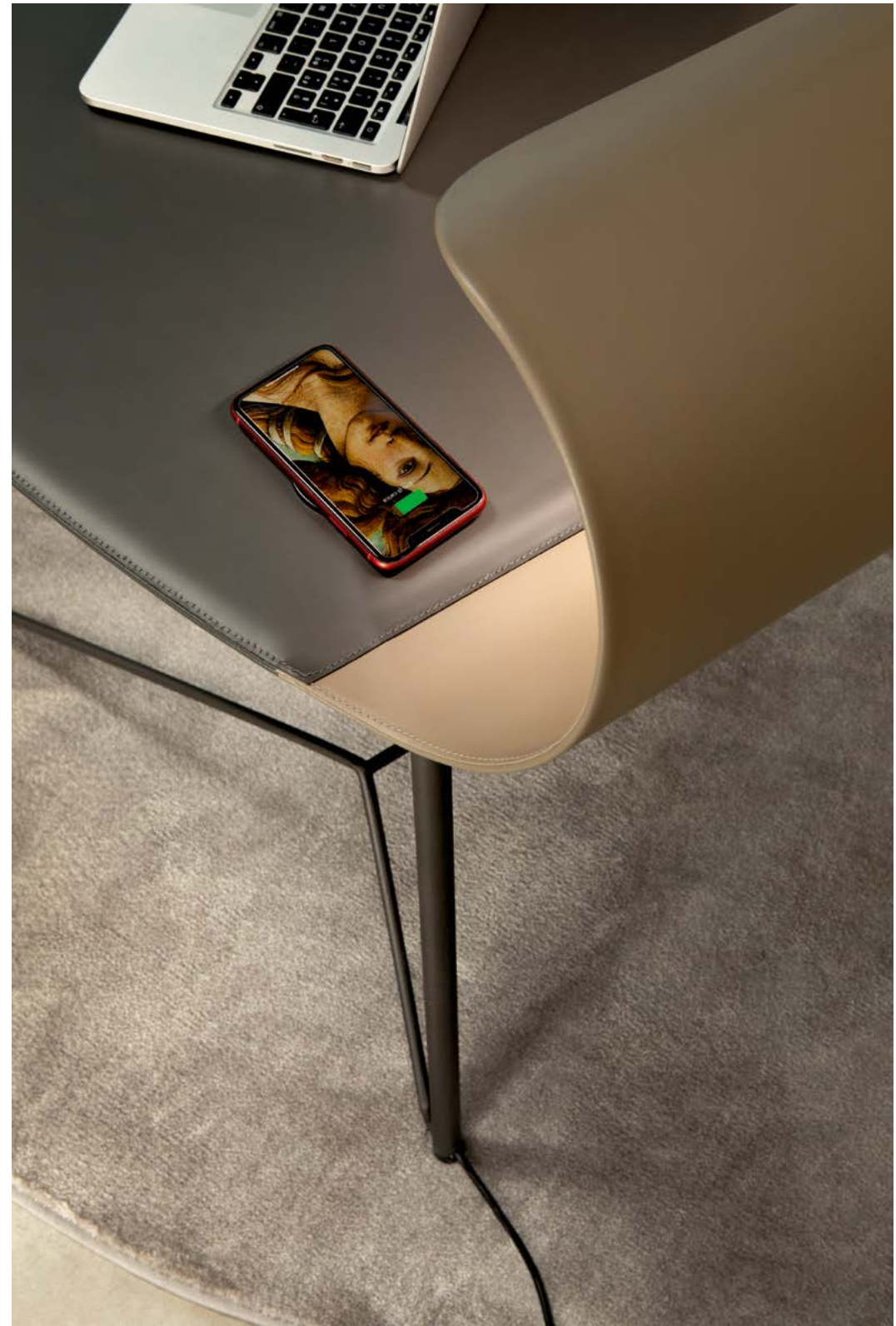



# venanzio

G. Codato | L. Trevisiol

Carrello multifunzione, portavivande, tavolino, complemento di design unico per stile: è Venanzio, l'alleato perfetto del living per inedite soluzioni di appoggio. Le forme essenziali, lineari e circolari, esaltano la sua estetica di forte personalità, che si compone di una struttura in metallo verniciato con finitura oro satinato, due ripiani di appoggio in porcellanato e top in vetro fumè.

Multifunctional trolley, lunch box, coffee table, complement of unique design for style: it is Venanzio, the perfect ally of the living room for unprecedented support solutions. The essential, linear and circular shapes enhance its strong personality aesthetic, which consists of a painted metal structure with a matt gold finish, two porcelain shelves and a smoked fumè top.

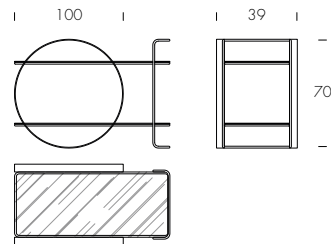

Venanzio  
struttura oro opaco / matt gold structure (85);  
top vetro fumè trasparente / transparent fumè glass top (V85);  
base gres Portoro / Portoro porcelain base (V85P).







# bijoux

Angelo Tomaiuolo

Come un prezioso gioiello, la lampada da soffitto Bijoux è un pezzo capace di arricchire ogni ambiente: due sottili ellissi inclinate sostengono il corpo illuminante, una sfera eterea in vetro soffiato dalla colorazione bianco latte, dalla quale affiora una luce che esalta l'ambiente circostante, con un armonioso effetto suggestivo. Bijoux è impreziosita da finiture oro e cromo nero.

Like a precious jewel, the Bijoux hanging lamp is a piece capable of enriching any environment: two slender inclined ellipses support the lighting body, an ethereal sphere in milky white blown glass, from which a light emerges that enhances the surrounding environment, with a harmonious suggestive effect. Bijoux is embellished with gold and black chrome finishes.

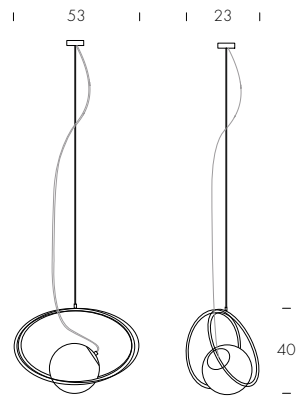

Bijoux  
struttura cromo nero e cromo oro / chrome black and chrome gold structure.



# breath

Opaca Lab

Il particolare design della lampada Breath si ispira ad un soffione che sparpaglia leggero la sua luce. È disponibile nelle versioni cristallo trasparente e fumè.

The particular design of the Breath lamp is inspired by a dandelion that scatters its light lightly. It is available in transparent and fumè glass versions.

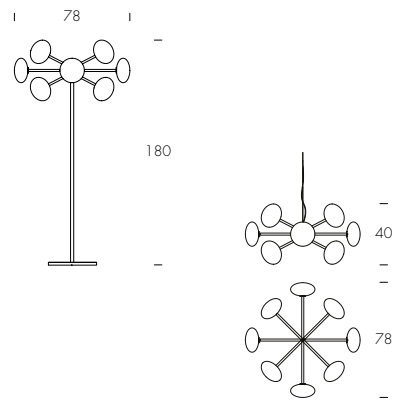

Breath  
struttura verniciato nero lucido/shiny black varnished structure (76);  
sfere vetro extrachiaro trasparente/transparent extra-clear glass spheres (V100).







Breath  
struttura verniciato nero lucido/shiny black varnished structure (76);  
sfere vetro fumè trasparente/transparent fumè glass spheres (V85).





# fullmoon

Tonin Casa Creatives

Lampada disponibile sia in versione da terra sia da tavolo, con base e stelo in acciaio verniciato e una boule in vetro soffiato. Fullmoon è adatta ad illuminare con stile qualsiasi ambiente.

Lamp available both in the floor and table version, with painted steel base and stem and a blown glass boule. Fullmoon is suitable for illuminating any environment with style.

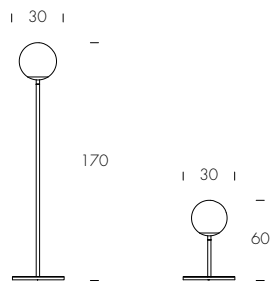

Fullmoon  
struttura bronzo pietra/stone bronze structure (83).





# klimt

Angelo Tomaiuolo

Le lampade a piantana e da tavolo Klimt si distinguono per la loro elegante base a treppiede e paralume in paglia di Vienna, per un living dal fascino indiscusso.

The Klimt floor and table lamps stands out for their elegant tripod base and lampshade in Vienna straw, for a living room with undisputed charm.

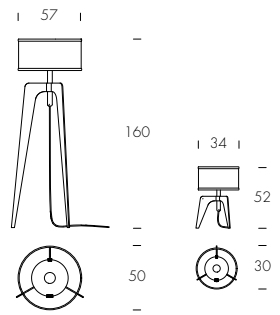

Klimt  
struttura titanio / titanium structure (34).







Klimt  
struttura bronzo pietra/stone bronze structure (83).





# mandala

Angelo Tomaiuolo

Lampada boule con un tubolare luminoso nel centro delle sfere, sospese da un leggero filo metallico, disponibile anche in versione da appoggio.

Boule lamp with a luminous tube in the center of the spheres, suspended by a light metal wire, also available in the table lamp version.

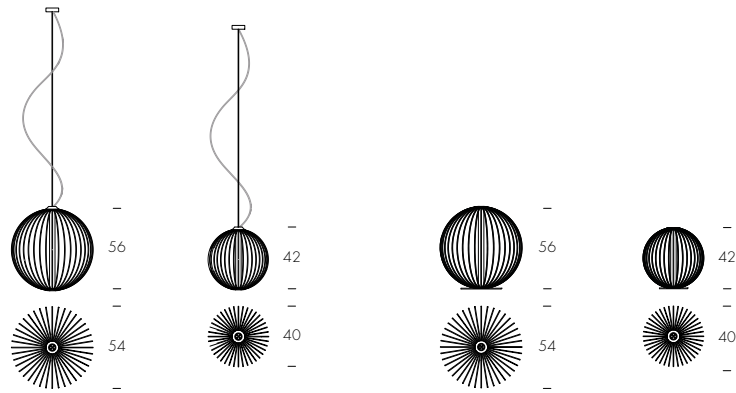

Mandala  
struttura oro opaco/matt gold structure (85).





Mandala  
struttura oro opaco/matt gold structure (85).





# mirò

Tonin Casa Creatives

La lampada da soffitto Mirò, ispirata nella sua linea onirica alle opere dell'omonimo artista spagnolo, disegna una calda e naturale sagoma a ellisse in legno massello: la particolarità della luce che si sprigiona dall'interno della lampada stessa valorizza ogni ambiente living.

The Mirò hanging lamp, inspired in its dreamlike line by the works of the Spanish artist with the same name, draws a warm and natural ellipse shape in solid wood: the particularity of the light that emanates from inside the lamp itself enhances any living environment.

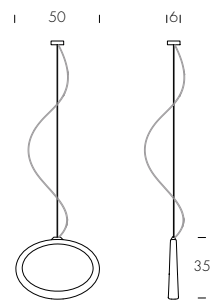

Mirò  
struttura frassino nero/  
black ash structure (25).





# shade

Opaca Lab

La lampada Shade, dalla particolare forma a cloche, illumina ogni ambiente con eleganza ed è disponibile in due varianti di dimensione.

The Shade lamp, with its particular cloche shape, illuminates every room with elegance and is available in two size variations.

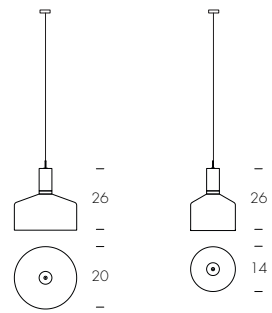

Mirò  
struttura vetro fumè e tabacco/  
fumè and tobacco glass structure (VS87, 90).







# bernini

Tonin Casa Creatives

Bernini è un letto dallo spirito senza tempo: l'elemento stilistico che lo contraddistingue è la grande testiera imbottita, con eleganti rifiniture che mostrano l'estrema cura per i dettagli. Disponibile anche con l'elegante cordonatura sulla testiera.

Bernini is a bed with a timeless spirit: the stylistic element that distinguishes it is the large upholstered headboard, with elegant finishes that shows extreme attention to detail. Also available with the elegant creasing on the headboard.

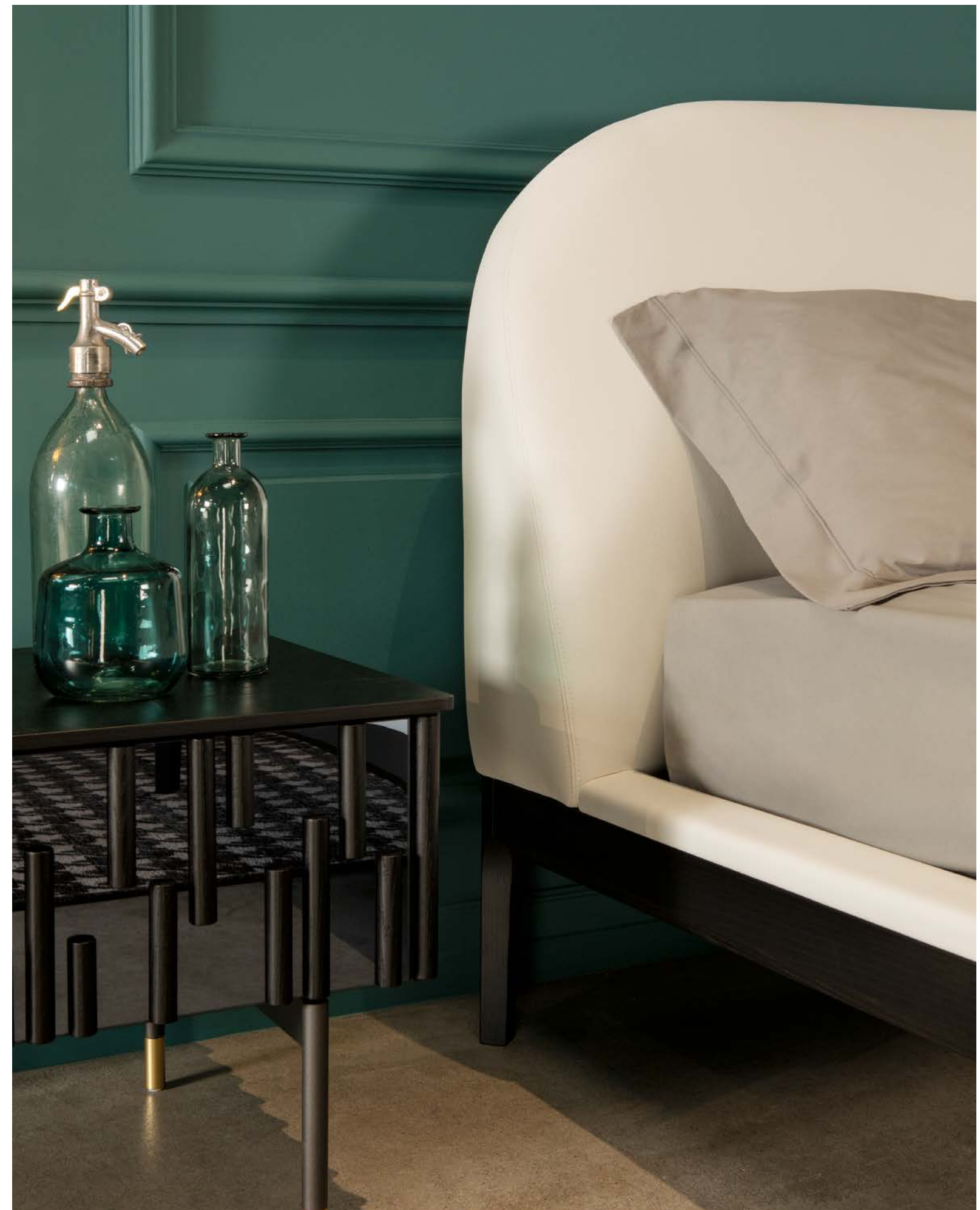
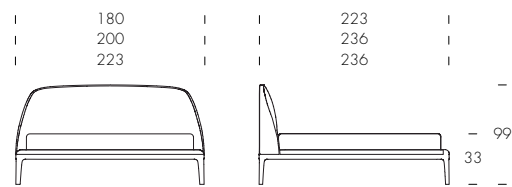



Bernini  
struttura frassino nero/black ash structure (2.5);  
rivestimento ecopelle bianco/white eco-leather covering (S01).





# havana

M. Mottin | E. Barbieri

Havana si contraddistingue per le caratteristiche strutturali del letto a baldacchino, che si possono unire anche alla pregiata lavorazione del cuoio sulla testata. Le finiture personalizzabili e la cura per i dettagli ne esaltano la sontuosità e lo spirito eclettico.

Havana stands out for the structural characteristics of the four-poster bed, which can also be combined with the fine thick-leather processing the customizable finishes and attention to detail enhance its sumptuousness and eclectic spirit.

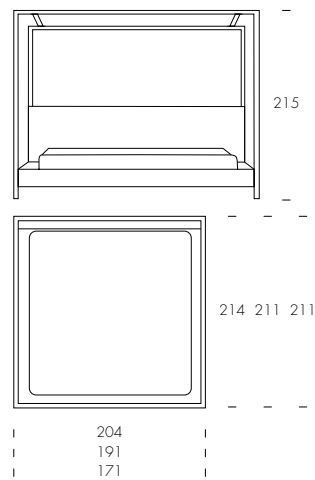







# mama

Angelo Tomaiuolo

Mama è il letto leader per quanto riguarda il concetto di morbidezza e calore. Si distingue per il particolare disegno sinuoso e avvolgente della testata, che ispira un comfort generoso e una sensazione di accogliente morbidezza.

Mama is the leading bed with regards to the concept of softness and warmth. It stands out for the particular sinuous and enveloping design of the headboard, which inspires generous comfort and a feeling of welcoming softness.

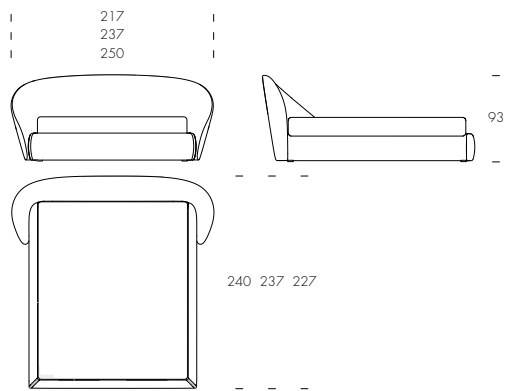



**Mama**  
rivestimento combinazione Grigio Intenso: tessuto Flora marrone-beige e pelle grigio/  
*Grigio Intenso combination covering: brown-beige Flora fabric and grey leather (01).*





# random

M. Mottin | E. Barbieri

Random è un letto molto ricercato, la sua linearità è arricchita dal molteplice utilizzo di materiali che costituiscono la testiera: elementi in pelle, legno massello e laccatura. Disponibile con varie possibilità di personalizzazione.

Random is a very refined bed, its linearity is enriched by the multiple use of materials that make up the headboard: elements in leather, solid wood and lacquering. Available with various customization possibilities.

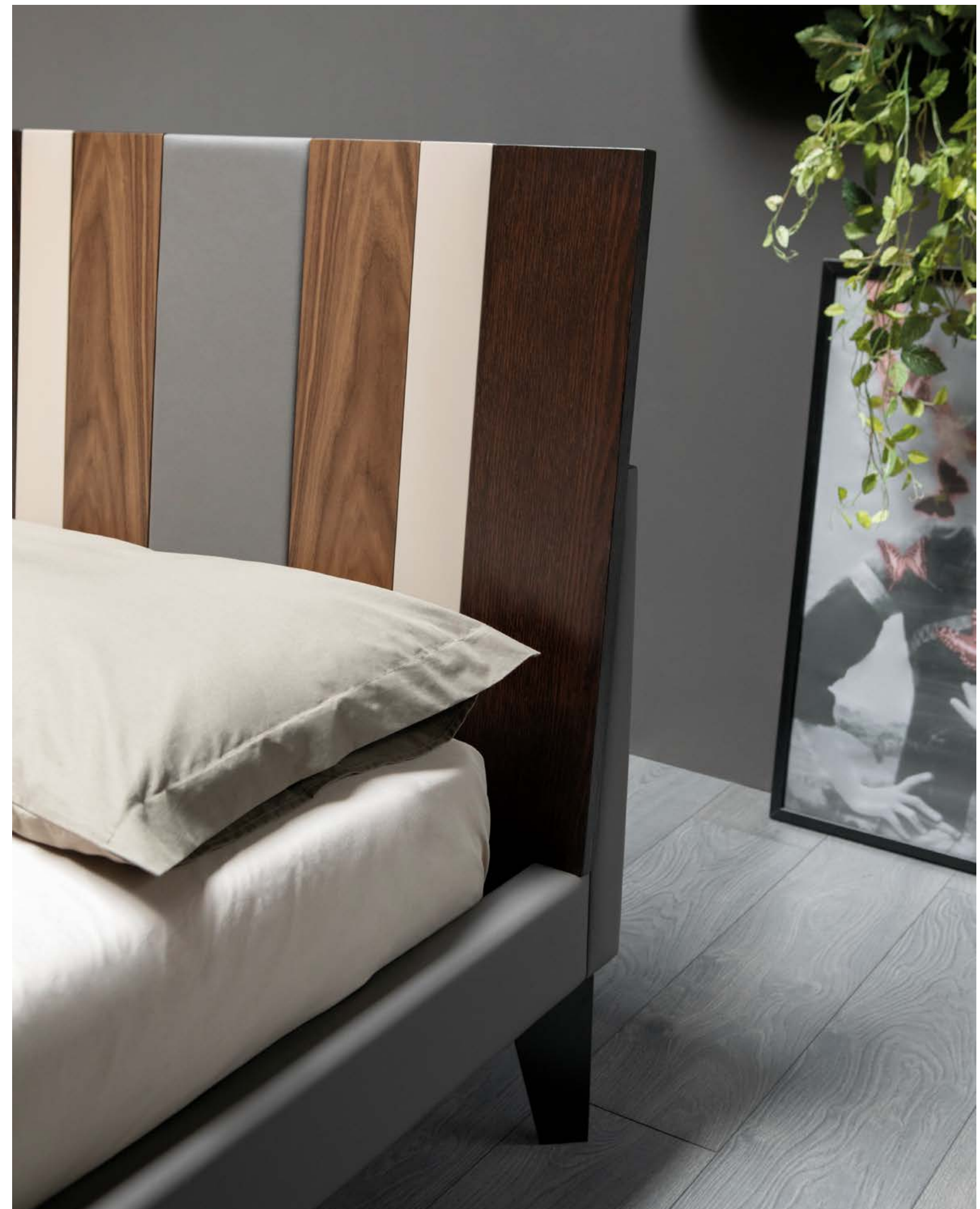
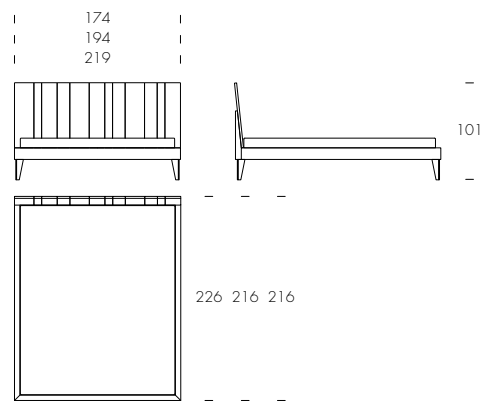





Random  
struttura rovere scuro, noce Canaletto, beige opaco e pelle grigio/  
dark oak, Canaletto walnut, matt beige and grey leather (P73).







# cubò

M. Mottin | E. Barbieri

Comodino con cassetto, struttura in noce canaletto, rovere scuro o frassino nero. Cubò, oltre che elemento d'arredo da terra, può anche essere sospeso e applicato alla parete.

Bedside table with drawer, canaletto walnut, dark oak or black ash structure. Cubò, as well as a floor-standing piece of furniture, can also be suspended and applied to the wall.

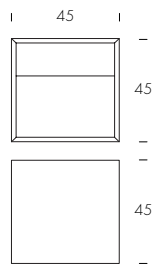

Cubò  
struttura noce Canaletto/  
Canaletto walnut structure (14).



# opera night

M. Mottin | E. Barbieri

A completare il programma Opera, così come i migliori best seller firmati Tonin Casa, si aggiunge Opera night. Questo gruppo notte formato da comodino, comò e settimanale, sposa perfettamente l'eleganza di una zona notte raffinata.

To complete the Opera program, as well as the best Tonin Casa best sellers, there is Opera Night. This night group, consisting of a bedside table, chest of drawers and a weekly wardrobe, perfectly marries the elegance of a refined sleeping area.

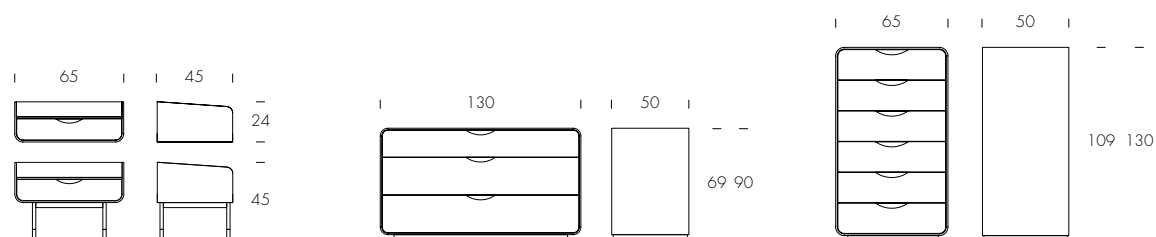



# orazio

Tonin Casa Creatives

Un design geometrico e essenziale per il comodino Orazio, con struttura in legno a contrasto, cassetto estraibile in finitura noce Canaletto e ampio vano interno di appoggio.

A geometric and essential design for the Orazio bedside table, with a contrasting wooden structure, a pull-out drawer in Canaletto walnut finish and a large internal support compartment.

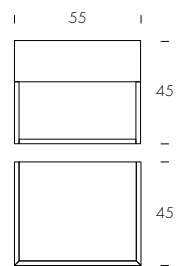

Orazio  
struttura nero opaco/matt black structure (02);  
cassetto noce Canaletto/Canaletto walnut drawer (14).







# atelier

Tonin Casa Creatives

Testa di moro, beige, fango, azzurro e marrone chiaro: 5 colori racchiusi in un tappeto dalla straordinaria eleganza che si adatta ai più pregiati tavoli firmati Tonin Casa.

Dark brown, beige, mud, light blue and light brown: 5 colours enclosed in a carpet with extraordinary elegance that adapts to the finest Tonin Casa tables.

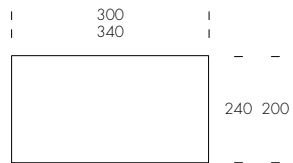



# geometric

Tonin Casa Creatives

Linee sottili che si intersecano tra di loro, creando forme geometriche e articolate: grazie ai dettagli color ottanio, Geometric dona modernità ad ogni stanza.

Thin lines that intersect each other creating geometric and articulated shapes: thanks to the oil blue colored details, Geometric gives modernity to any room.

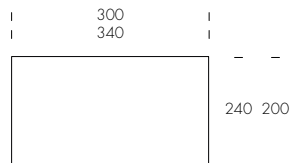







# boule

Opaca Lab

I vasi Boule sono un accessorio elegante dalla bellezza eccezionale: composti da una base plissettata e da una bolla in ceramica, possono ospitare nel corpo sferico fiori e piante ornamentali o servire da soli come prezioso elemento decorativo. Una collezione versatile per ogni spazio della tua casa.

Boule vases are an elegant accessory of exceptional beauty: composed of a pleated base and a ceramic bubble, they can house flowers and ornamental plants in the spherical body or serve alone as a precious decorative element. A versatile collection for any space in your home.



Boule

struttura blu oceano opaco, grigio quarzo opaco/  
matt ocean blue, matt quartz grey structure (03, 02).





# impero

Opaca Lab

Impero è una composizione di vasi con tre dimensioni differenti, così da poter essere abbinati tra loro. L'anello in oro in foglio applicato a mano impreziosisce nobilmente la fierezza di questi raffinati elementi d'arredo.

Impero is a composition of vases with three different sizes, in order to be combined with each other. The hand-applied gold foil ring nobly embellishes the pride of these refined furnishings.

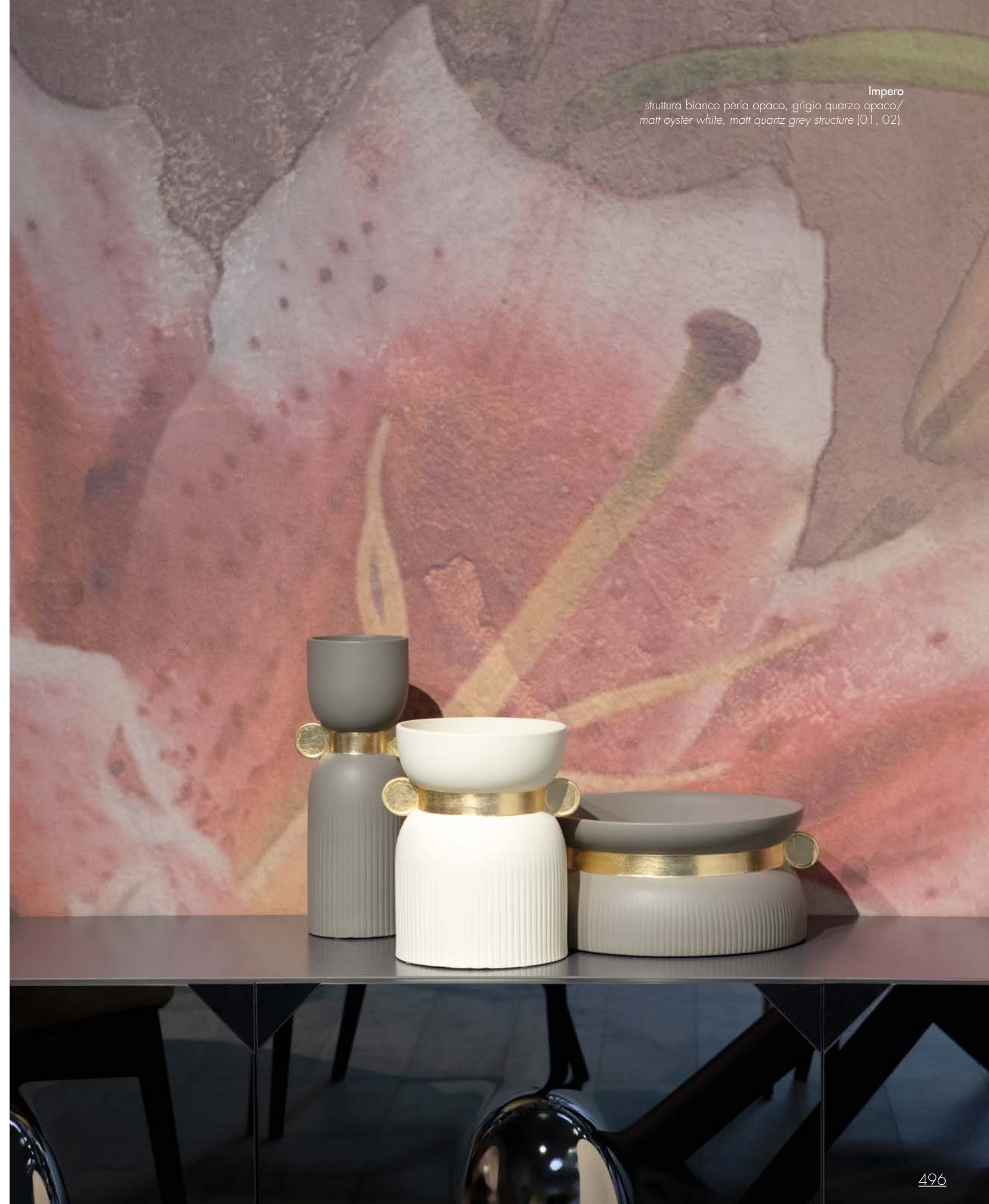
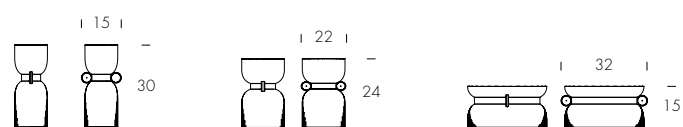

Impero  
struttura bianco perla opaco, grigio quarzo opaco/  
matt oyster white, matt quartz grey structure (01, 02).



# kaspar basket

Angelo Tomaiuolo

I cesti optional della libreria Kaspar, disponibili in due misure, nelle varianti in cuoio color cognac e arancio Siracusa o in paglia di Vienna, sono versatili e adatti anche da utilizzare come portariviste o portaoggetti.

The optional baskets of the Kaspar bookcase, available in two sizes, in the cognac and Siracusa orange thick-leather or in Vienna straw versions, are versatile and also suitable for use as a magazine rack or objects holder.

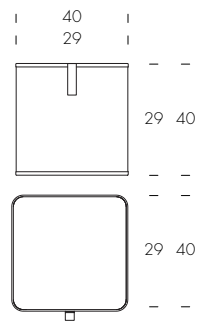

Kaspar  
cesti paglia di Vienna, cuoio cognac/Vienna straw, cognac thick leather (PGL1, K59).



# plumage

Cristina Celestino

Visione contemporanea ed eccellenza artigianale si fondono in questo elemento di design unico, che si aggiunge alla madia che utilizza la collezione Plumage. Questo vaso ispirato al piumaggio degli uccelli trasformato in tessere di ceramica decorate a mano, disegnato da Cristina Celestino per BottegaNove, si compone di una cascata di piume sovrapposte l'una all'altra, a comporre forme grafiche e inaspettate textures. Finitura con base in platino in esclusiva per la collezione Tonin Casa.

Contemporary vision and artisan excellence come together in this unique design element, which is added to the sideboard that uses the Plumage collection. This vase inspired by the plumage of birds transformed into hand-decorated ceramic tiles, designed by Cristina Celestino for BottegaNove, it consists of a cascade of overlapping feathers, to compose unexpected graphic patterns and textures. Platinum base finish exclusively for the Tonin Casa collection.

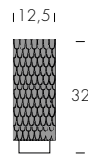







# wallpapers

Tonin Casa Creatives



Amaryllis



Bali Touch



Clay Symphony



Creative Leaves



Bloom



Brick Ground



Flower Bomb



Night Forest



Calla



Chevron

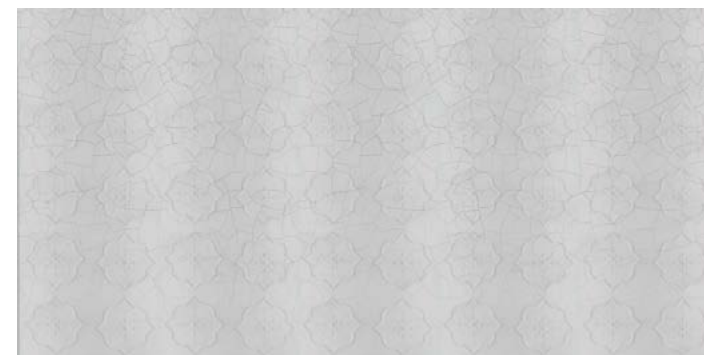

Plaster







# V\_P gres porcellanato

V\_P porcelain stoneware



V\_01P Statuario Altissimo  
Statuario Altissimo



V\_55P Onice Ambra  
Onyx Amber



V\_92P Terra Liquida  
Terra Liquida



V\_93P Agata Naturale  
Agata Natural



V\_73P Onice Grigio  
Onyx Grey



V\_83P Emperador  
Emperador

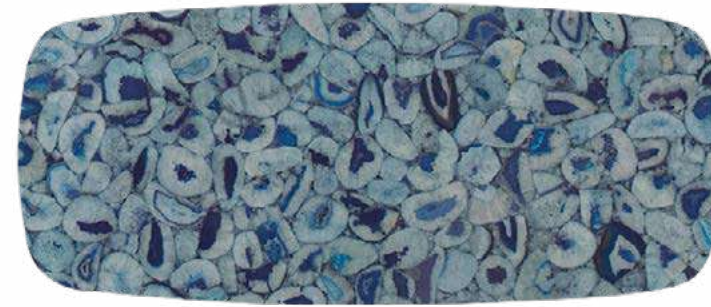

V\_94P Agata Blu  
Agata Blue



V\_95P Agata Black  
Agata Black



V\_85P Portoro Lucido | V\_74P Portoro Opaco  
Glossy Portoro | Matt Portoro



V\_87P Macchiavvecchia Lucido | V\_88P Macchiavvecchia Opaco  
Glossy Macchiavvecchia | Matt Macchiavvecchia



V\_96P Saphir Noir Lucido | V\_97P Saphir Noir Opaco  
Glossy Saphir Noir | Matt Saphir Noir



V\_98P Noisette  
Noisette



V\_89P Symphonie  
Symphonie



V\_90P Crème Lucido | V\_91P Crème Opaco  
Glossy Crème | Matt Crème



V\_99P Choco  
Choco

# V\_P gres porcellanato

V\_P porcelain stoneware



# V\_C vetro ceramicato

V\_C ceramic glass



V\_01C Bianco  
White

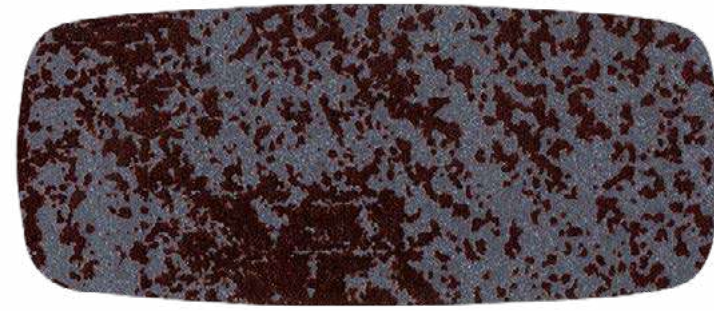

V\_02C Nero  
Black



V\_03C Moro  
Dark Brown

# M marmi

M marble



M\_101 Bianco Carrara  
Carrara White



M\_102 Nero Marquinia  
Marquinia Black



M\_129 Port Saint-Laurent  
Port Saint-Laurent



M\_130 Fior di Pesco  
Fior di Pesco



M\_131 Saint Denis  
Saint Denis



M\_132 Calacatta Oro  
Calacatta Gold



M\_183 Bronzo Emperador  
Bronze Emperador



# E essenze

---

E essenze



14 Noce Canaletto  
Canaletto Walnut



16 Rovere Scuro  
Dark Oak



17 Rovere Naturale  
Natural Oak



25 Frassino Nero  
Black Ash



IT

Tonin Casa si riserva di apportare, senza preavviso, modifiche nei materiali, nei rivestimenti, nelle finiture e nei disegni dei prodotti presentati in questo catalogo. Le texture e i colori dei materiali e delle finiture hanno valore indicativo in quanto soggetti alle tolleranze dei processi di stampa.

È vietata ogni riproduzione totale e parziale in Italia e all'estero.

ES

Tonin Casa se reserva el derecho de aportar modificaciones de dibujo, materiales, acabados y tapicerías, sin que esté obligada a dar aviso anticipado. Las texturas y los colores de los materiales y de los acabados tienen solo un valor indicativo porque están sujetos a la tolerancia en los procesos de imprenta.

Prohibida la reproducción total o parcial en Italia y en el extranjero.

EN

Tonin Casa reserves the right to change, without previous notice, materials, covers, finishes and drawings of the products presented in this catalogue. The textures and colours of materials and finishes are indicative as they are depending on the tolerances of the printing process.

Total or partial reproduction of the products is prohibited in Italy and abroad.

FR

Tonin Casa se réserve le droit d'apporter, sans préavis, des modifications au niveau des matériaux, des revêtements, des finitions et du design des produits présentés dans ce catalogue. Les textures et les couleurs des matériaux et des finitions sont une valeur indicative parce-que ils changent selon la tolérance aux procédés d'imprimerie.

La reproduction, totale ou partielle, est interdite, que ce soit en Italie ou à l'étranger.

RU

Tonin Casa оставляет за собой право, без каких-либо предупреждений, вносить изменения в используемые материалы, обивки, отделки и изображения продукции, представленной в данном каталоге.

Текстура и цвета материалов и отделок имеют ориентировочный характер, так как могут варьироваться в процессе печати.

progetto  
design



Tonin Casa is a brand of  
Progetto Design International srl

via Guglielmo Marconi, 37  
35010 San Pietro in Gu (PD), Italy

t +39 049 9453300  
f +39 049 9450725

info@tonincasa.it  
c.f. P.iva IT03817150240

COPYRIGHT © Progetto Design International srl  
Tutti i diritti riservati - All rights reserved

Stampa *Print*:

Grafiche Antiga

Stampato in Italia Dicembre 2021 *Printed in Italy in December 2021*



**Tonin**  

---

**CASA**