

Identity

2021

Rimadesio

- 8 Insegna luminosa, *Light box*
- 12 Logotipo, *Logotype*
- 14 Illuminazione tecnica, *Technical lighting*
- 16 Finiture architettoniche, *Architectural finishes*

- 22 Campionario, *Sample box*
- 28 Display tecnico, *Technical display*
- 32 Display tecnico bifacciale, *Doublesided technical display*
- 44 Tavole tecniche, *Technical boards*
- 46 Tavole materiali, *Material boards*
- 48 Campioni, *Samples*
- 50 Cataloghi, *Catalogues*
- 52 Display tecnico monofacciale, *Singlesided technical display*
- 58 Tavole materiali, *Material boards*

- 64 Segna prodotto, *Nameplates*
- 66 Oggetti di styling, *Styling kit*
- 92 Complementi suggeriti, *Suggested complements*

- 94 Zona giorno, *Living area*
- 158 Zona notte, *Night area*

La declinazione della Corporate Identity Rimadesio nel progetto del punto vendita: le modalità espositive dell'azienda si evolvono per comunicare l'ampiezza tipologica della collezione.

Il presente manuale descrive le nuove soluzioni di campionatura: veri e propri "spazi Rimadesio" che riuniscono porte, sistemi componibili e complementi in ambientazioni articolate e stilisticamente coerenti, dalla zona giorno alla zona notte. Alla descrizione degli ambienti si affianca la panoramica completa di tutte le soluzioni per la caratterizzazione degli showroom.

Rimadesio Corporate Identity Katalog als nuetzliches Mittel bei der Gestaltung von Rimadesio Ausstellungen: die Firma hat Vorschlaege entwickelt, um die umfangreiche Kollektion zu praesentieren. Dieses Handbuch beschreibt neue Loesungen fuer die Ausstellung: echte "Rimadesio Räume", bestehend aus Türen, modulare Systeme und Zubehör in ausgearbeitete Wohnbereiche mit einem stilistischen Zusammenhang in allen Bereichen. Persoenlichkeit und Charakterisierung fuer die Ausstellungsraeume.

L'identité de Rimadesio véhiculée dans le projet du point de vente: l'entreprise propose des solutions élaborées pour communiquer au mieux sur un vaste choix de la collection. Ce manuel décrit les nouvelles solutions d'implantation: des espaces Rimadesio qui associent les portes, les systèmes modulaires, et les compléments dans des lieux divers et cohérents dans le style, de la partie jour à la partie nuit. Une description des lieux et de toutes les solutions pour caractériser un show-room.

La declinación de la Corporate Identity Rimadesio en el proyecto del punto de venta: las modalidades de exposición de la empresa se evolucionan para comunicar la amplitud tipológica de la colección. Este manual describe las nuevas soluciones de exposición: verdaderos y propios "espacios Rimadesio" que constan de puertas, sistemas modulares y complementos en ambientes articulados y coherentes en estilo, de la zona de día a la zona de noche. A la descripción de los ambientes se acompaña una visión completa de todas las soluciones para la caracterización de los showroom.

The declination of Rimadesio Corporate Identity on the project of the store: Rimadesio exhibition arrays evolve to communicate the typological largeness of the collection. This manual describes new solutions in matter of exhibition: an outright "Rimadesio area" that includes doors, modular systems and accessories in a well-structured and stylistically coherent location, from the living area to the bedroom. The description of the location is accompanied by a comprehensive overview of all the solutions for the characterization of the showrooms.

- 8 Insegna luminosa, *Light box*
- 12 Logotipo, *Logotype*
- 14 Illuminazione tecnica, *Technical lighting*
- 16 Finiture architettoniche, *Architectural finishes*

Soluzioni corporate degli spazi,
Corporate space solutions



Rimadesio ha elaborato due soluzioni per la caratterizzazione delle vetrine dei propri showroom monomarca, tramite cassonetto luminoso. La versione su misura, presentata a fianco, si integra nella vetrina esistente, mentre la versione sospesa, presentata nella pagina successiva, è disponibile nelle larghezze 1200 e 1600 mm. Tutte le soluzioni possono essere sviluppate dall'ufficio progetti Rimadesio per adattarsi alle esigenze di ogni showroom.

Rimadesio has developed two solutions for the characterization of the store windows of its flagship stores, using light boxes. The custom-made version, presented on the opposite page, is integrated in the existing store window, while the suspended version, presented on the following page, is available in widths 1200 and 1600 mm. Every solution can be developed by the Rimadesio Project Development Department to suit the needs of each showroom.

Rimadesio hat zwei Lösungen von Leuchtreklame, für die Charakterisierung der Schaufenster seiner Exklusivshowroom-Ausstellungen, entwickelt. Die Leuchtreklame auf Mass wie auf dem Bild dargestellt, die sich im Schaufenster sich perfekt integriert und die abgehängte Innen-Leuchtreklame in Breite 1200mm und 1600mm erhältlich. (auf der nächsten Seite). Beide Lösungen werden von unseren Planungsbüro entwickelt um die beste Lösung finden zu können.

Rimadesio a développé deux solutions pour la personnalisation des vitrines des showrooms par une enseigne lumineuse. La version sur mesure, présentée à côté, s'intègre dans le vitrine existante, tandis que la version suspendue, présentée dans la page suivante, est disponible dans les largeurs 1200 et 1600 mm. Toutes les solutions peuvent être développées par le bureau Projets Rimadesio pour s'adapter aux exigences de chaque show-room.

Rimadesio ha desarrollado dos soluciones para la caracterización de los escaparates de propios showroom monomarcas, utilizando una insignia luminosa. La versión a medida, presentada al lado, se integra en el escaparate existente, en cambio la versión suspendida, presentada en siguiente pagina esta disponible en los anchos 1200 y 1600 mm. Todas las soluciones pueden ser desarrolladas por la oficina Proyectos de Rimadesio para adaptarse a las necesidades de cada showroom.

Dimensioni Dimensions



Materiali Materials

Cassonetto esterno su misura: scatolato in lamiera verniciata nero opaco RAL 9004 protetto per esterno. Illuminazione interna a led.

Custom-made outdoor box: nero opaco RAL 9004 painted metal sheet protected for outdoor use. Interior led lighting.

Aussen-Leuchtreklame nach Mass: Geschuetzte Kastenformige Struktur nero opaco RAL 9004. Innenbeleuchtung mit led.

Caisson sur mesure pour l'extérieur: élément en métal laqué nero opaco RAL 9004 prévu pour l'usage extérieur. Eclairage intérieur avec led.

Insignia exterior a medida: caja de chapa pintada nero opaco RAL 9004 protegida para el exterior. Iluminación interior con led.

Dimensioni
Dimensions



Materiali
Materials

Sospensione per interno:
scatolato in lamiera verniciata
RAL 9004 nero opaco.
Illuminazione interna a led.

Suspended indoor version:
nero opaco RAL 9004 painted
metal sheet.
Interior led lighting.

Abgehaengte In-
nen-Leuchtreklame: Kasten-
foermige Struktur nero opaco
RAL 9004.
Innenbeleuchtung mit led.

Suspension pour l'intérieur:
élément en métal laqué nero
opaco RAL 9004.
Éclairage intérieur avec led.

Suspensión para interior: caja
de chapa pintada nero opaco
RAL 9004.
Iluminación interior con led.





Rimadesio prevede un'ampia varietà di soluzioni per la declinazione del logo istituzionale all'esterno e all'interno degli showroom.
 A fianco: il marchio a rilievo in metacrilato, per applicazione esterna sulle vetrine, è previsto in tre larghezze. In alternativa è disponibile la vetrofania adesiva colore bianco RAL 9010.
 Il logo all'interno dello showroom, presentato nella pagina successiva, viene utilizzato per identificare e delimitare lo spazio dedicato alle proposte Rimadesio.

Rimadesio provides a wide variety of solutions for the declination of the institutional logo outside and inside the showroom.
 On the opposite page: the thick embossed methacrylate steel brand, for external application on store windows, is provided in three widths. As an alternative there is an adhesive sticker in finishing Pure white RAL 9010.
 Inside the showroom the logo is used to identify and define the space dedicated to Rimadesio proposals: different 10 mm thick embossed in piombo painted acrylic versions are provided.

Rimadesio bietet eine Vielzahl von Lösungen, für die Anwendung des institutionellen Logos, innen und ausserhalb des Showrooms.
 Neben: das Firmenlogo aus Methacrylat, für Aussen-Anwendung auf die Schaufenster, ist in drei Breiten verfügbare. Andernfalls gibt es ein Logo, zum kleben, in weiß RAL 9010.
 Das Logo im Showroom wird verwendet, um den Rimadesio Raum zu identifizieren und definieren: es gibt Relief-Versionen, Dicke 10 mm, Acryl silber lackiert.

Rimadesio fournit toute une gamme de solutions pour la déclinaison du logo usuel à l'extérieur et à l'intérieur du show-room.
 A côté: le logo en méthacrylate, pour une application externe sur les vitrines; il est proposé en trois largeurs. Alternativement, nous proposons la vitrophanie adhésive blanche RAL 9010.
 Le logo du show-room est utilisé pour identifier et définir l'espace dédié à Rimadesio: il existe des versions en relief ép. 10 mm en acrylique de couleur piombo.

Rimadesio ofrece una gran variedad de soluciones para la declinación del logo institucional dentro y fuera de los showrooms.
 Al lado: el logo en relieve en metacrilato, para aplicación exterior en los escaparates, se proporciona en tres anchuras. Como alternativa, es disponible la etiqueta adhesiva de color blanco RAL 9010.
 El logo en el interior del showroom se utiliza para identificar y definir el espacio dedicado a Rimadesio: existen versiones en relieve grosor 10 mm en acrílico pintado color piombo.

Materiali Materials

Logo per esterno ed interno in metacrilato colore piombo sp 10 mm.
 In alternativa, solo per la vetrina, è disponibile una vetrofania colore bianco opaco RAL 9010.

Lead painted methacrylate logo for outdoor and indoor, 10 mm thick. As an alternative, only for windows, there is an adhesive sticker in finishing Pure white RAL 9010.

Firmenlogo für Aussen und Innen-Anwendung aus Methacrylat in der Farbe piombo 10 mm stark.
 Alternativ für das Schaufenster ist der weisse RAL 9010 Firmenlogo aufzukleben.

Logo pour extérieur et intérieur en méthacrylate de couleur plomb épaisseur 10 mm.
 Alternativement, seulement pour la vitrine, est disponible une vitrophanie de couleur blanche opaque RAL 9010.

Logo para exterior e interior en metacrilato color piombo 10 mm de espesor.
 Como alternativa, solo para la vitrina, está disponible un papel para vidrios color blanco mate RAL 9010.

La scelta dei sistemi di illuminazione è fondamentale per creare un impianto espositivo preciso e curato in ogni dettaglio. Rimadesio Studio suggerisce alcune soluzioni in grado di assicurare un risultato illuminotecnico di alto livello e di grande qualità.

The choice of lighting systems is essential to create an exhibition area characterise by meticulous attention to detail. Rimadesio Studio suggests some solutions able to ensure a high level and high quality lighting result.

Die Wahl der Beleuchtungssysteme ist maßgeblich, um eines präzises Ausstellungssystem mit Liebe zum Detail zu schaffen. Rimadesio Studio bietet einige Vorschläge, die ein qualitativ hochwertiges Beleuchtungsergebnis gewährleisten können.

Le choix des systèmes d'éclairage est fondamental pour créer un espace d'exposition précis et soigné dans les moindres détails. Rimadesio Studio suggère certaines solutions permettant de garantir un résultat technique d'éclairage haut de gamme et de qualité élevée.

La elección de los sistema de iluminación es fundamental para crear un entorno de exposición preciso y cuidadosamente diseñado. Rimadesio Studio propone una serie de soluciones capaces de garantizar un resultado de iluminación de alto nivel y calidad.

Prodotti suggeriti
Suggested products

FLOS
Spot 120

Profilo: Tracking magnet surface
Montaggio a soffitto: su binario
Colore faretto e binario: nero
Ottica: spot
Angolo del fascio: 17°
CRI: 90
Tipo di illuminazione: diretta
Temperatura: 3000°k

GUZZINI
Palco LV51 Q656

Profilo: Low voltage
Montaggio a soffitto: su binario
Colore faretto e binario: nero
Ottica: spot
Angolo del fascio: 12°
CRI: min 90
Tipo di illuminazione: diretta
Temperatura: 3000°k

DELTA LIGHT
SPY 66 92718 ADM

Profilo: TRACK 3F DIM ON
Montaggio a soffitto: su binario
Colore faretto e binario: nero
Ottica: spot
Angolo del fascio: 18°
CRI: > 90
Tipo di illuminazione: diretta
Temperatura: 3000°k

REGGIANI
YORI EVO Precision 12°

Profilo: Surface Slim
Montaggio a soffitto: su binario
Colore faretto e binario: nero
Ottica: spot
Angolo del fascio: 12°
CRI>90
Tipo di illuminazione: diretta
Temperatura: 3000° k



Posizionamento
Position

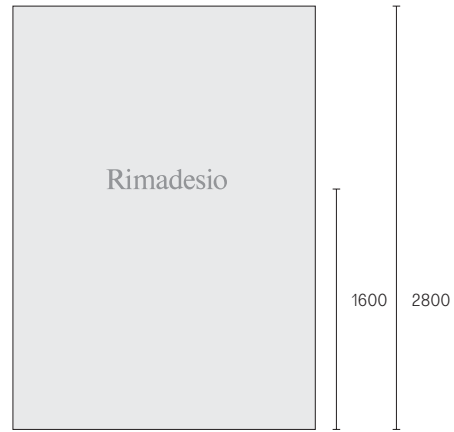

Dimensioni
Dimensions

Il logo in metacrilato colore piombo di spessore 10 mm è previsto in tre dimensioni standard: L 400, 600, 800 mm. Per il posizionamento del logo è prevista una dima in forex. Il logo per vetrine è provvisto di retro adesivo da interno color piombo.

The 10mm thick lead painted methacrylate logo is available in three standard dimensions: W 400, 600, 800 mm. A forex template is available for the logo installation. The logo for store windows is provided with lead painted indoor adhesive back.

Der Firmenlogo aus Metacrylat Farbe piombo ist 10 mm stark und ist in 3 Standardbreiten: B 400 mm, B 600 mm und B 800 mm verfügbar. Für die Montage des Logos steht eine Schablone aus Kunststoff zur Verfügung. Der Logo ist mit einem grauen Kleber für den Innenebereich ausgestattet.

Le logo en méthacrylate de couleur plomb, de 10 mm d'épaisseur est prévu en trois dimensions standard: L 400, 600, 800 mm. Pour le positionnement du logo on fournira un modèle en plastique. Le logo de la vitrine, pour l'intérieur, de couleur plomb est prévu autocollant, derrière.

El logo en metacrilato color piombo 10 mm de espesor está previsto en tres dimensiones estándares: L 400, 600, 800 mm. Para el posicionamiento del logo se proporciona una muestra en forex. El logotipo para el escaparate está compuesto de un adhesivo trasero para interior color piombo.





L'estetica Rimadesio, elaborata dall'azienda attraverso le immagini della propria comunicazione e l'allestimento degli spazi espositivi istituzionali, è il risultato di una ricerca che coinvolge anche gli elementi architettonici dello spazio, dai pavimenti alle pareti. Per questo l'azienda ha definito materiali e finiture di ogni superficie, riservate agli showroom che desiderano creare spazi che rispecchiano al 100% la visione stilistica Rimadesio.

The aesthetics of Rimadesio, developed by the company through images of its own communication and the fitting of institutional exhibition areas is the result of a research that also involves the use of architectural elements of the space, from floors to walls. For this reason the company has selected materials and finishings for each of the internal surfaces, reserved to those customers whose idea is to create spaces that totally reflect the stylistic concept of Rimadesio.

Ausführungen des architektonischen Aufbau. Rimadesio definiert fuer seine Ausstellung-Planungen, eine besondere Ausstattung den Raum, Waende und Fussboden, laut Rimadesio Aesthetik. Deshalb hat die Firma, Materialien und Ausfuehrungen der Oberflaeche, fuer die Showroom, bestimmt, die 100% der stilistischen Rimadesio Vision entsprechen.

L'esthétique de Rimadesio, véhiculé à travers la publicité et l'équipement des espaces d'exposition, est le résultat d'une recherche qui implique également les éléments architecturaux de l'espace, sols et murs compris. Pour cette raison Rimadesio a défini les matériaux et les finitions de chaque zone, réservée aux show-rooms qui veulent créer des espaces qui reflètent à 100% la vision stylistique de Rimadesio.

La estética Rimadesio, desarrollada por la empresa a través de las imágenes de su comunicación y la preparación de los espacios expositivos institucionales, es el resultado de una investigación que también implica los elementos arquitectónicos del espacio, de los suelos a las paredes. Por tanto la empresa ha definido materiales y acabados de cada área, reservada a los showrooms que quieren crear espacios que reflejan al 100% la visión estilística de Rimadesio.

Pareti Walls



Intonaco cementizio
RAL 7044 grigio seta

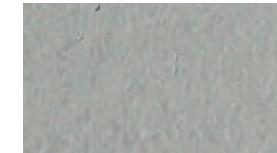

Idropittura
RAL 7044 grigio seta



Parquet rovere grigio

Strutture espositive Exhibition frameworks



Intonaco cementizio
RAL 7044 grigio seta

Pavimenti Floors



Resina cementizia
RAL 7030 grigio pietra

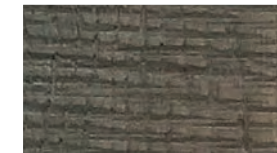

Parquet rovere grigio

- 22 Campionario, *Sample box*
- 28 Display tecnico, *Technical display*
- 32 Display tecnico bifacciale, *Doublesided technical display*
- 44 Tavole tecniche, *Technical boards*
- 46 Tavole materiali, *Material boards*
- 48 Campioni, *Samples*
- 50 Cataloghi, *Catalogues*
- 52 Display tecnico monofacciale, *Singlesided technical display*
- 58 Tavole materiali, *Material boards*

Strumenti di vendita, *Material tools*



Rimadesio garantisce alla propria rete vendita una completezza di strumenti in grado di rispondere a tutte le esigenze del progetto: dal campionario di 258 finiture, al listino prezzi, ai cataloghi più aggiornati destinati a professionisti e clienti finali. Alla documentazione fisica si affianca il supporto informatico del software Pigreco, l'esclusivo programma di progettazione creato dall'azienda.

Rimadesio guarantees to its sales network a completeness of tools able to meet all the needs of the project: from the sample collection of 258 finishes, to the price list, to the most up-to-date catalogues intended for professionals and end customers. The physical documentation is complemented by the information technology support of Pigreco software, the exclusive design programme created by the company.

Rimadesio garantiert seinem Vertriebsnetz die Vollständigkeit der Tools, die allen Projektanforderungen gerecht werden: von der Musterkollektion mit 258 Oberflächen über die Preisliste bis hin zu den aktuellsten Katalogen für Fachleute und Endkunden. Die physische Dokumentation wird von der Pigreco-Software unterstützt, dem exklusiven Designprogramm des Unternehmens.

Rimadesio assure à son réseau de vente une gamme complète d'outils répondant à tous les besoins du projet : du carnet d'échantillons de 258 finitions, au tarif, aux catalogues actualisés destinés aux professionnels et aux particuliers. Aux documents papier s'ajoute le support informatique du logiciel Pigreco, le programme exclusif de conception créé par notre société.

Rimadesio garantiza a su red de ventas una gama de herramientas completa para satisfacer todas las necesidades del proyecto: desde un muestrario de 258 acabados hasta una lista de precios y los catálogos más actualizados para profesionales y clientes finales. La documentación física está flanqueada por el soporte informático del software Pigreco, el programa de diseño exclusivo creado por la empresa.



Il campionario materiali è un utile strumento di lavoro che comprende i cataloghi Rimadesio e tutte le 258 finiture attualmente in collezione. L'intera gamma finiture è raccolta in 4 contenitori di legno organizzati in 16 cassette, all'interno dei quali trovano posto tutti i campioni in formato 10x10cm. Ciascun cassetto è dotato di appositi separatori in gomma, per garantire una conservazione ordinata e sicura.

The sample box is a useful tool, including the Rimadesio catalogues and all the 258 finishes currently in the collection. The whole range of finishes is gathered into 4 wooden boxes divided in 16 drawers, inside which all the 10x10cm samples are ranked. Each drawer is equipped with special rubber dividers, to grant a tidy and safe storage.

Die Musterbox ist ein wichtiges Arbeitsmittel, das Rimadesio Kataloge und alle 258 aktuellen Ausführungen beinhaltet. Die Materialmuster sind 10x10cm gross und befinden sich in 4 Holzbehälter unterteilt in 16 Schubladen. Jede Schublade hat eine Inneneinteilung, um eine geordnete und sichere Aufbewahrung zu garantieren.

Le box échantillons est un outil de travail, qui comprend les catalogues Rimadesio et toutes les 258 finitions actuellement dans la collection. L'ensemble des finitions est rassemblé dans 4 conteneurs en bois organisés en 16 tiroirs, à l'intérieur desquels tous les échantillons en format 10x10cm sont rangés. Chaque tiroir est équipé de séparateurs en caoutchouc, pour assurer un stockage ordonné et sûr.

El muestrario es una herramienta de trabajo útil que incluye los catálogos de Rimadesio y todos los 258 acabados que están actualmente en la colección. Toda la gama de acabados se recoge en 4 contenedores de madera organizados en 16 cajones, en cuyo interior se colocan todas las muestras en formato 10x10cm. Cada cajón está equipado con separadores de goma especiales, para garantizar un almacenamiento ordenado y seguro.

Dimensioni Dimensions

I campioni finiture hanno dimensione 100x100 mm. Il campionario materiali si compone di 1 contenitore Cataloghi e 4 contenitori Finiture, la cui dimensione è L 275 H 333 P 334. L'ingombro totale è L 1375 H 333 P 334.

The finishes samples are 10x10cm. Il campionario materiali si compone di 1 contenitore Cataloghi e 4 contenitori Finiture, la cui dimensione è L 275 H 333 P 334. L'ingombro totale è L 1375 H 333 P 334.

Diese Muster sind 100x100 mm gross. Die Musterbox besteht aus 1 Katalogbehälter und 4 Behälter für Materialmuster mit den Maßen B275 H333 T334mm. Das Gesamtmaß beträgt B1375 H 333 T 334mm

Les échantillons des finitions mesurent 100x100 mm. Le box échantillons se compose de 1 conteneur Catalogues et 4 conteneurs Finitions, avec les suivantes dimensions L 275 H 333 P 334. L'encombrement totale est L 1375 H 333 P 334.

Las muestras de los acabados son de 100x100 mm. La muestra de material consta de 1 contenedor Catálogos y 4 contenedores Acabados, cuyo tamaño es L 275 H 333 D 334. La dimensión total es L 1375 H 333 P 334.

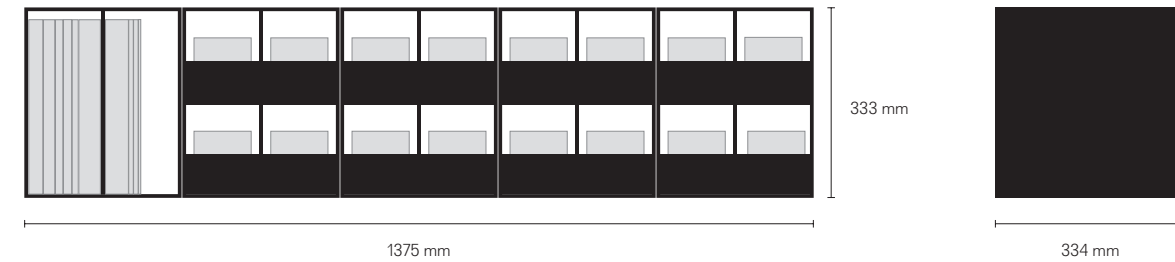



Esteticamente versatili, affidabili nel tempo, completamente riciclabili: sono le qualità distintive dell'alluminio e del vetro, da sempre costanti imprescindibili della proposta Rimadesio. A questi si aggiungono nuovi materiali, selezionati secondo logiche precise: di natura stilistica ed estetica nel caso di marmo, essenze e tessuti; di opportunità ambientale rispetto a proposte di nuova concezione come il Litech, la similpelle e i melaminici.

Aesthetically versatile, reliable over time, completely recyclable: these are the distinctive qualities of aluminium and glass, which have always been essential constants of the Rimadesio proposal. They are complemented by new materials, selected according to precise logics: of a stylistic and aesthetic nature in the case of marble, wood and fabrics; of environmental opportunity with respect to new concept proposals such as Litech, synthetic leather and melamine.

Die unverwechselbaren Eigenschaften von Aluminium und Glas sind ihre ästhetische Vielseitigkeit, ihre Zuverlässigkeit über Jahre hinaus und die Tatsache, dass sie vollständig recycelbar sind. Dies sind seit jeher auch die wesentlichen Konstanten des Rimadesio Angebots. Hierzu gesellen sich neue Materialien, die einer präzisen Logik folgend ausgewählt wurden. Diese ist stilistischer und ästhetischer Natur bei Marmor, Essenzen und Stoffen und basiert mehr auf Umweltkriterien bei neuen Konzeptvorschlägen wie Litech, Kunstleder und Melamin.

L'aluminium et le verre, qui sont depuis toujours des constantes indispensables de l'offre Rimadesio ont pour qualité d'être esthétiquement versatiles, entièrement recyclables et durables. S'ajoutent à ceux-ci de nouveaux matériaux, sélectionnés selon des logiques précises: de nature stylistique et esthétique dans le cas du marbre, des bois et tissus; d'opportunité environnementale pour la proposition de nouvelle conception comme le Litech, le similicuir et les mélaminés.

Estéticamente versátiles, fiables a lo largo del tiempo, completamente reciclables: éstas son las cualidades distintivas del aluminio y el cristal, que siempre han sido constantes esenciales de la propuesta de Rimadesio. A ellos se suman nuevos materiales, seleccionados según lógicas precisas: de carácter estilístico y estético en el caso del mármol, las maderas y los tejidos; de oportunidad medioambiental respecto a propuestas de nuevo concepto como el Litech, el simil cuero y la melamina.

Campioni finiture:

- n.46 Vetro laccato opaco
- n.46 Vetro laccato lucido
- n.26 Vetro sahara
- n.7 Vetro diamante
- n.4 Vetro reflex
- n.7 Vetro rete
- n.6 Vetro satinato
- n.7 Vetro trasparente
- n.2 Vetro neutro
- n.55 Alluminio
- n.8 Cuoio
- n.7 Similpelle
- n.8 Tessuto Lux
- n.7 Tessuto Material
- n.5 Melaminico
- n.5 Essenza
- n.4 Litech
- n.8 Marmo

Finishes samples:

- n.46 Mat lacquered glass
- n.46 Glossy lacquered glass
- n.26 Sahara glass
- n.7 Diamante glass
- n.4 Reflex glass
- n.7 Mesh glass
- n.6 Satinated glass
- n.7 Transparent glass
- n.2 Neutral glasses
- n.55 Aluminium
- n.8 Leather
- n.7 Synthetic leather
- n.8 Lux fabric
- n.7 Material fabric
- n.5 Melamine
- n.5 Wood
- n.4 Litech
- n.8 Marble

Materialmuster:

- n.46 Matte lackierte Gläser
- n.46 Glänzende lackierte Gläser
- n.26 Gläser Sahara
- n.7 Gläser Diamante
- n.4 Reflex Gläser
- n.7 Rete Gläser
- n.6 Satinierte Gläser
- n.7 Transparente Gläser
- n.2 Neutrale Gläser
- n.55 Aluminium
- n.8 Leder
- n.7 Kunstleder
- n.8 Gewebe lux
- n.7 Gewebe Material
- n.5 Melamin
- n.5 Hölze
- n.4 Litech
- n.8 Marmor

Échantillons des finitions:

- n.46 Verres laqués mats
- n.46 Verres laqués brillants
- n.26 Verres Sahara
- n.7 Verres diamante
- n.4 Verres Reflex
- n.7 Verres rete
- n.6 Verres satinés
- n.7 Verres transparents
- n.2 Verres neutres
- n.55 Aluminium
- n.8 Cuir
- n.7 Similicuir
- n.8 Tissu lux
- n.7 Tissu Material
- n.5 Melamin
- n.5 Bois
- n.4 Litech
- n.8 Marbre

Muestras acabados:

- n.46 Cristales lacados mate
- n.46 Cristales lacados brillantes
- n.26 Cristales Sahara
- n.7 Cristales Diamante
- n.4 Cristales Reflex
- n.7 Cristales rete
- n.6 Cristales satinados
- n.7 Cristales transparentes
- n.2 Cristales neutros
- n.55 Aluminio
- n.8 Cuero
- n.7 Simil cuero
- n.8 Tejido lux
- n.7 Tejido Material
- n.5 Melaminico
- n.5 Maderas
- n.4 Litech
- n.8 Mármol



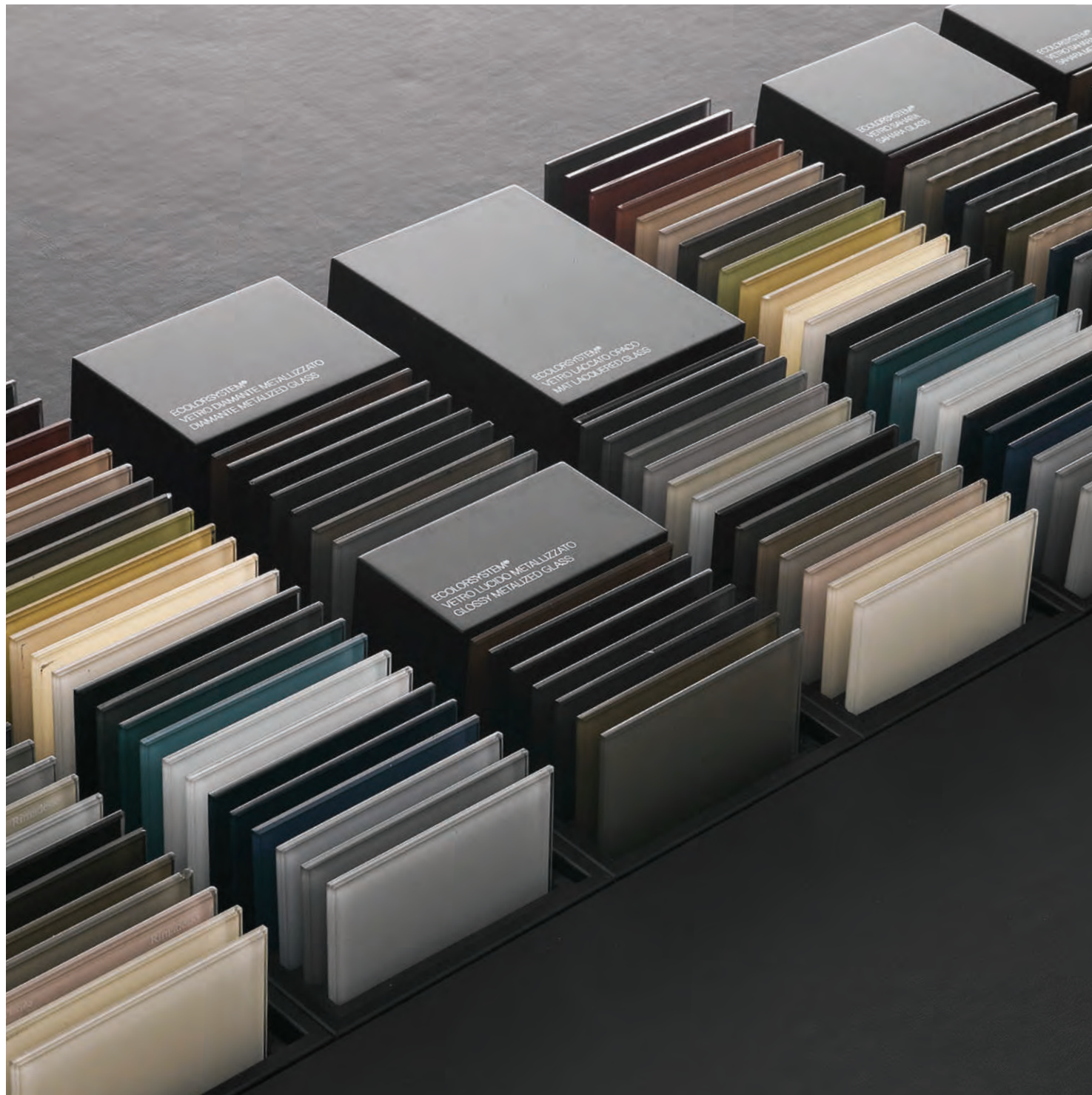

Appositamente progettato per gli showroom monomarca Rimadesio, il display tecnico è disponibile in due versioni: bifacciale centralista e monofacciale a parete. Uno strumento di lavoro pratico e completo che comprende, oltre al campionario finiture in formato 100x100mm, un'accurata selezione di materiali di vendita, essenziali per la progettazione d'interni e per il dialogo con professionisti e clienti finali.

Specially designed for Rimadesio monobrand showrooms, the technical display is available in two versions: double-sided and single-sided. A practical and complete working tool that includes, in addition to the finish samples in 100x100mm format, a careful selection of sales materials, essential for interior design and for dialogue with professionals and end customers.

Das speziell für Rimadesio-Einzelmarken-Showrooms konzipierte technische Display ist in zwei Versionen erhältlich: doppelseitig in der Raummitte und einseitig an der Wand. Es ist ein praktisches und komplettes Arbeitsgerät, das neben den Oberflächenmustern im Format 100 x 100mm eine sorgfältige Auswahl an Verkaufsmaterialien enthält, die für die Inneneinrichtung und für den Dialog mit Profis und Endkunden unerlässlich sind.

Le présentoir technique, spécialement conçu pour les showrooms monomarque Rimadesio, est disponible en deux versions : à deux faces pour être placé au centre de la pièce ou avec une seule face pour être placé contre un mur. Un outil de travail pratique et complet qui comprend, le box d'échantillons des finitions en format 100x100 mm, et un plus une sélection précise de matériaux de vente, essentiels pour la conception d'intérieurs et pour dialoguer avec les professionnels et les particuliers.

Especialmente diseñado para los showrooms monomarca de Rimadesio, el expositor técnico está disponible en dos versiones: bifacial central y monofacial en pared. Una práctica y completa herramienta de trabajo que incluye, además del muestrario de acabados en formato 100x100mm, una precisa selección de materiales de venta, imprescindibles para el diseño de interiores y para el diálogo con los profesionales y clientes finales.



Lato fronte
Front side

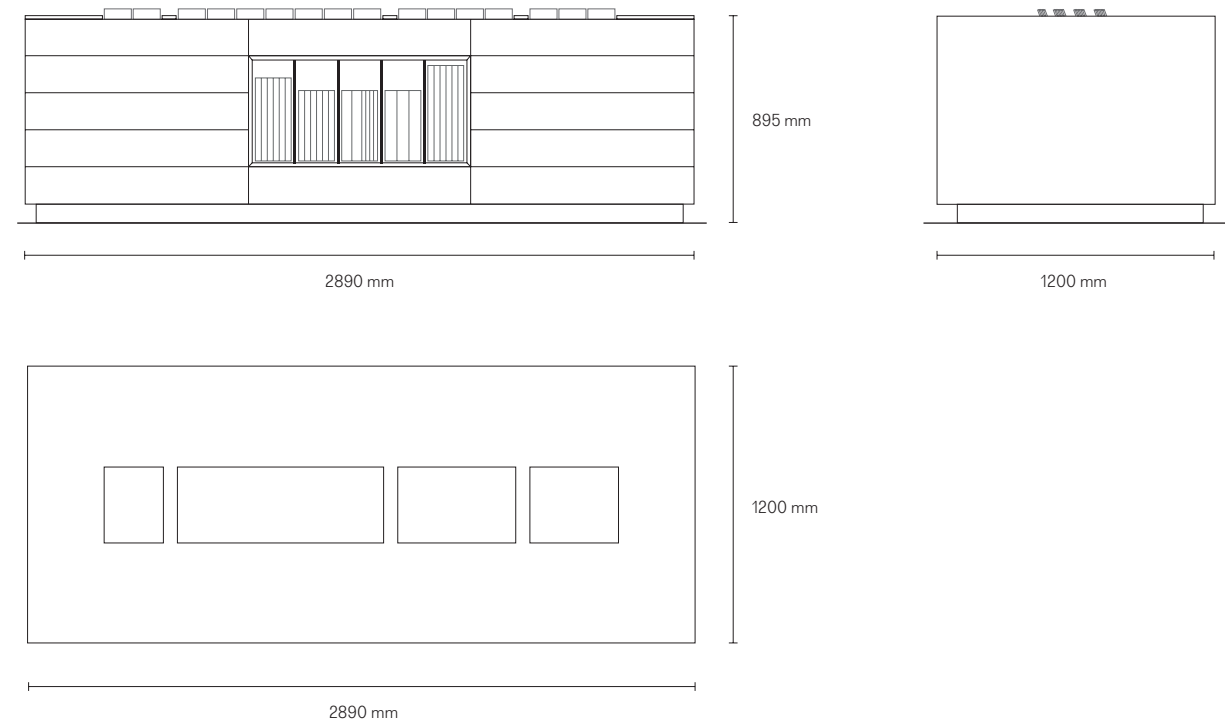

La versione bifacciale propone una dotazione completa di tutti gli strumenti di vendita studiati da Rimadesio. Nella parte superiore sono alloggiati le 258 finiture in collezione, presentate in formato 100x100mm. Sul Lato fronte trovano spazio i cataloghi, i listini prezzi e la documentazione destinata al cliente finale. I cassetti a estrazione totale ospitano 6 tavole materiali e una scorta di campioni finiture.

The double-sided version offers a full complement of all the material tools designed by Rimadesio. The upper part houses the 258 finishes of the collection, presented in 100x100mm format. On side A there are catalogues, price lists and documentation for the end customer. The fully extractable drawers include the 6 material boards and a stock of finishing samples.

Die doppelseitige Version bietet ein komplettes Set aller Verkaufstools, die von Rimadesio. Im oberen Teil sind die 258 Oberflächen der Kollektion im 100x100mm Format untergebracht. Auf der A Seite befinden sich Kataloge, Preislisten und Dokumentationen für den Endkunden. Die vollständig ausziehbaren Schubladen haben 6 Materialmuster und einen Vorrat an Ausführungsmustern.

La version à deux faces propose une dotation complète de tous les instruments de vente étudiés par Rimadesio. La partie supérieure permet de loger les 258 finitions de la collection, présentées dans un format 100x100mm. Les catalogues, tarifs et la documentation destinée au particulier sont placés sur le côté A. Les tiroirs totalement extractibles contiennent 6 tableaux matériaux et une réserve d'échantillons de finitions.

La versión bifacial ofrece un equipamiento completo de herramientas de venta diseñadas por Rimadesio. La parte superior alberga los 258 acabados de la colección, presentados en formato 100x100mm. En la cara A hay catálogos, listas de precios y documentación para el cliente final. Los cajones de extracción total dan cabida a 6 tablas de materiales y a un stock de muestras de acabados.



Lato fronte: Tavole materiali
Front side: Material boards

1. Flap door	2. Flap door	3. Flap door
4. MB1 MB2 MB3		5. MB4 MB5 MB6
6. Samples stock		7. Samples stock
8. Samples stock		9. Samples stock
10. Catalogues stock	11. Catalogues stock	12. Catalogues stock

4. MB1 MB2 MB3

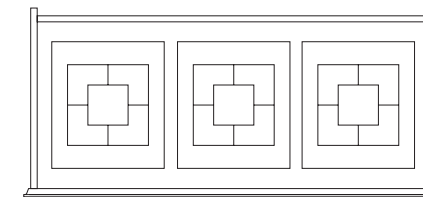

5. MB4 MB5 MB6

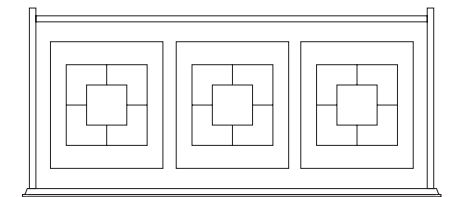

6. Samples stock

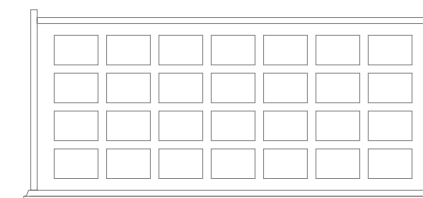

7. Samples stock

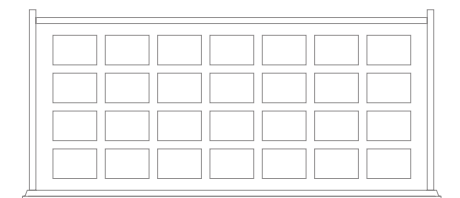

8. Samples stock

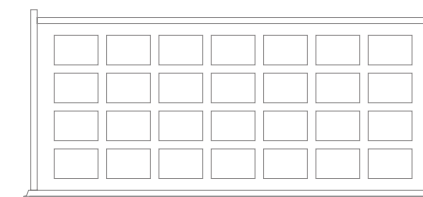

9. Samples stock

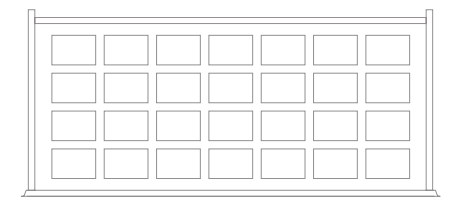



Lato fronte: scorte finiture
 Front side: stock of finishes

1. Flap door	2. Flap door	3. Flap door
4. MB1 MB2 MB3		5. MB4 MB5 MB6
6. Samples stock		7. Samples stock
8. Samples stock		9. Samples stock
10. Catalogues stock	11. Catalogues stock	12. Catalogues stock

4. MB1 MB2 MB3

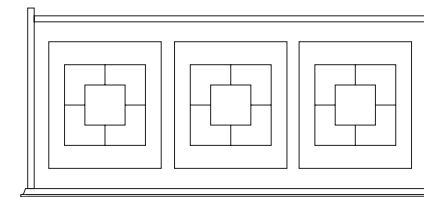

5. MB4 MB5 MB6

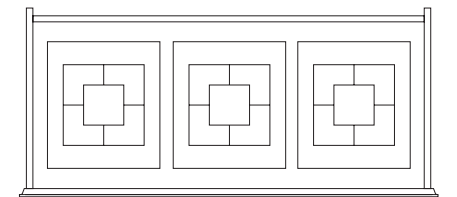

6. Samples stock

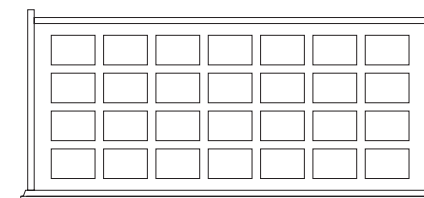

7. Samples stock

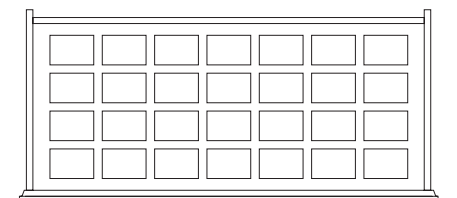

8. Samples stock

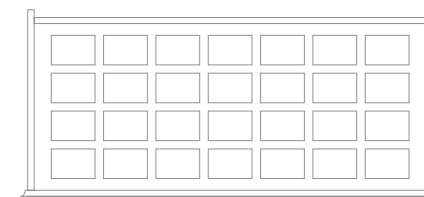

9. Samples stock

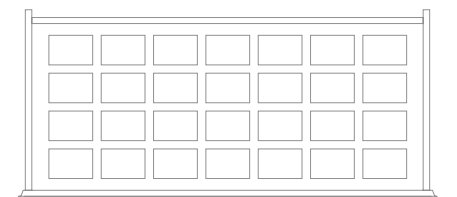



Lato fronte: scorte finiture
 Front side: stock of finishes

1. Flap door	2. Flap door	3. Flap door
4. MB1 MB2 MB3		5. MB4 MB5 MB6
6. Samples stock		7. Samples stock
8. Samples stock		9. Samples stock
10. Catalogues stock	11. Catalogues stock	12. Catalogues stock

4. MB1 MB2 MB3

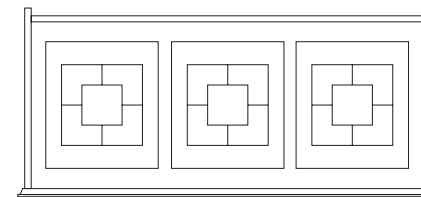

5. MB4 MB5 MB6

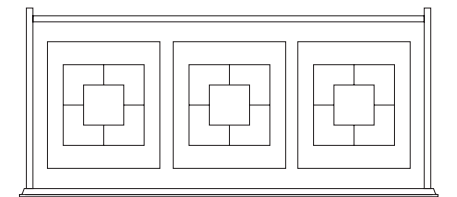

6. Samples stock

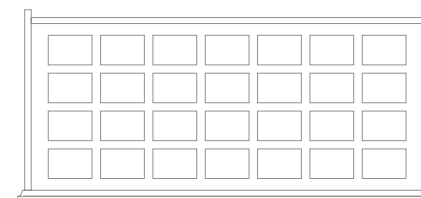

7. Samples stock

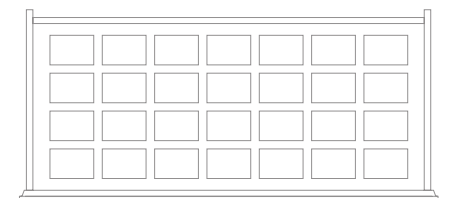

8. Samples stock

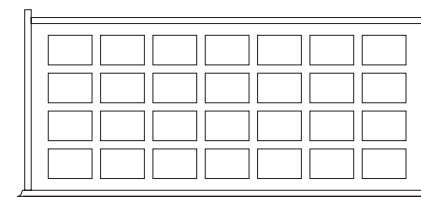

9. Samples stock

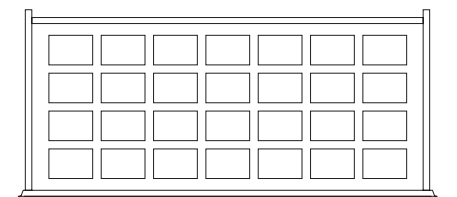



Lato retro
Back side

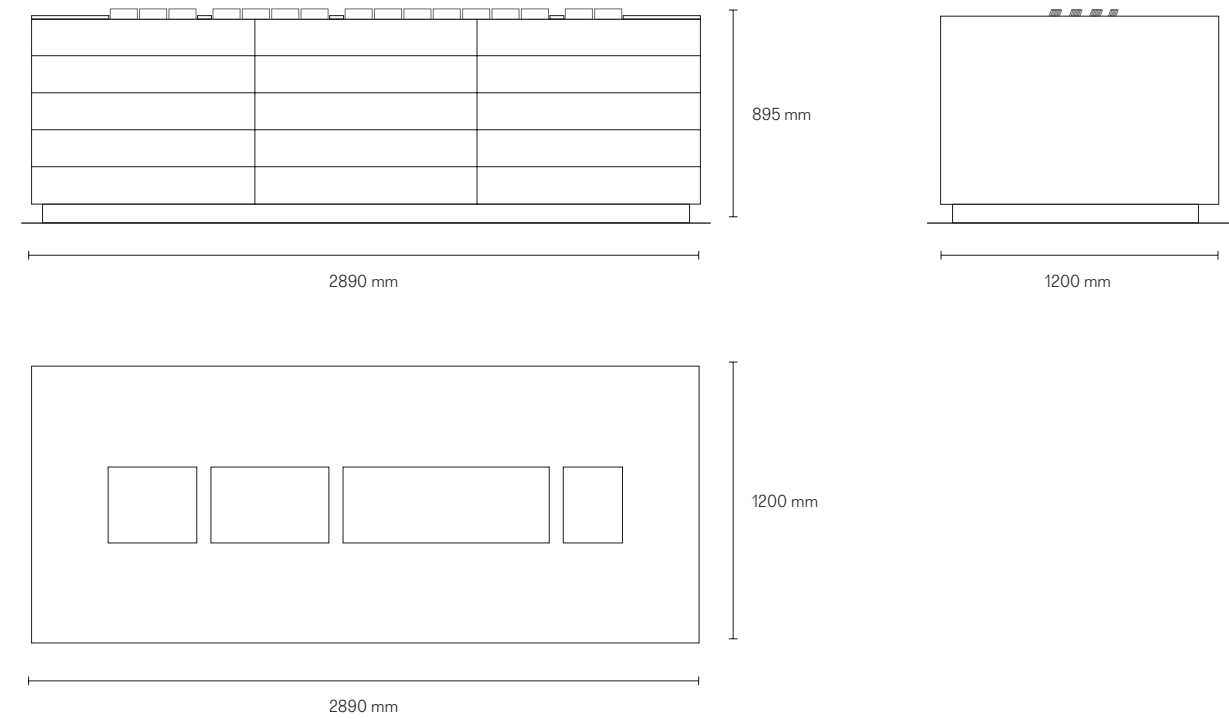

Il Lato retro del display bifacciale comprende 3 vani a ribalta e 12 cassetti in cui sono alloggiati 23 tavole tecniche relative ai principali sistemi in collezione.

The back side of the double-sided display includes 3 flap compartments and 12 drawers, housing the 23 technical boards relating to the main systems of the collection.

Die Rückseite des doppelseitigen Displays umfasst 3 Klappfächer und 12 Schubladen, in denen 23 technische Schemata zu den Hauptsystemen der Kollektion untergebracht sind.

Le côté arrière du présentoir à deux faces comprend 3 meubles abattants et 12 tiroirs dans lesquels sont logés les 23 tableaux techniques concernant les principaux systèmes de la collection.

La parte posterior del expositor bifacial incluye 3 compartimentos abatibles y 12 cajones en los que se almacenan 23 tablas técnicas de los principales sistemas de la colección.



Lato retro: Tavole tecniche
Back side: Technical boards

1. Flap door	2. Flap door	3. Flap door
4. MD1 MD2 MD3	5. MD4 MD5 MD6	6. MD7 MD8 MD9
7. TV1 TV2 TV3	8. SZ1 SZ2 SZ3	9. SZ4 SZ5
10. LP1 LP2 AU1	11. MN1 MN2 MN3	12.
13. Catalogues stock	14. Catalogues stock	15. Catalogues stock

<p>4. MD1 MD2 MD3</p> <p>Modulor adjustable lateral filler Modulor terminal profile Modulor closing filler or opening passage with fanlight</p>	<p>5. MD4 MD5 MD6</p> <p>Modulor terminal closing filler Modulor door by pulling for one-side wall paneling Modulor door by pushing for double side wall paneling</p>	<p>6. MD7 MD8 MD9</p> <p>Modulor internal corner Modulor panel for external corner Modulor storage</p>
<p>7. TV1 TV2 TV3</p> <p>Single wall rail Single ceiling rail Single built-in rail</p>	<p>8. SZ1 SZ2 SZ3</p> <p>Spazio single profile with fixed panel Spazio single profile with swing door Spazio double profile with fixed panel and sliding door</p>	<p>9. SZ4 SZ5</p> <p>Spazio fixed panels with corner joint and T-shaped upright Spazio fixed panel with sliding and swing door</p>
<p>10. LP1 LP2 AU1</p> <p>Swing door with standard jamb Swing door with slim jamb Magnetic double directional door</p>	<p>11. MN1 MN2 MN3</p> <p>Swing door with pull and push opening Wall flush swing door Ceiling flush swing door</p>	<p>12. Samples stock</p>



Le tavole tecniche sono uno strumento di supporto alla progettazione dei principali sistemi Rimadesio. Realizzate in formato 366x255mm, sono asportabili dai cassetti per una miglior praticità d'uso.

The material boards are meant to be a supporting tool to design the main Rimadesio systems. Made in 366x255mm format, they can be removed from the drawers for greater ease of use.

Die technischen Schemata dienen zur Unterstützung für das Designen der wichtigsten Rimadesio-Systeme. Sie haben eine Größe von 366 x 255 mm und können für eine bessere Benutzerfreundlichkeit aus den Schubladen entnommen werden.

Les tableaux techniques sont un instrument de support à la conception des principaux systèmes Rimadesio. Réalisées en format 366x255mm, ils peuvent être retirés des tiroirs pour une utilisation plus pratique.

Las tablas técnicas son una herramienta de apoyo al diseño de los principales sistemas de Rimadesio. Realizadas en formato 366x255mm, se pueden extraer de los cajones para facilitar su uso.

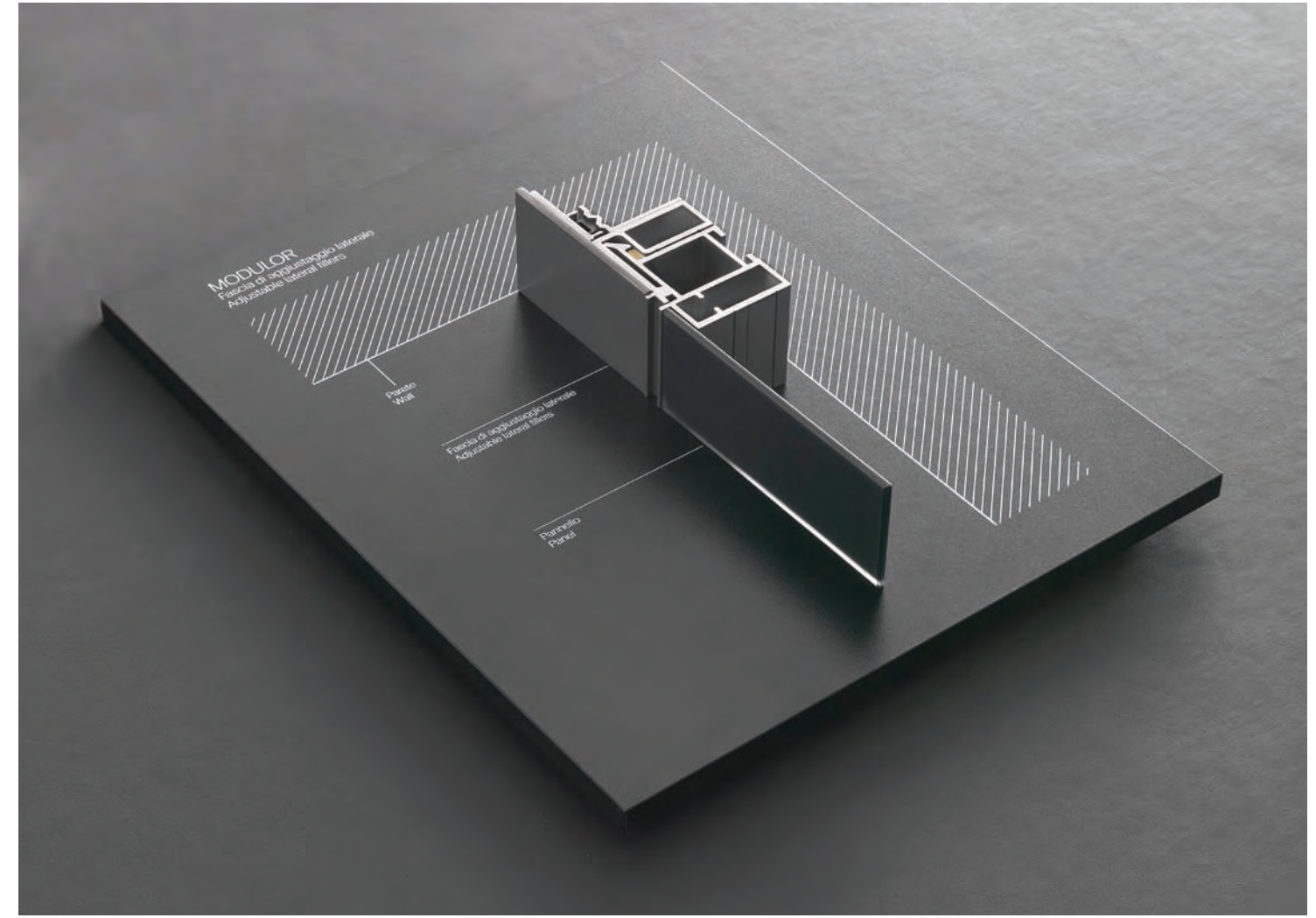

Tavole tecniche, *Technical boards*

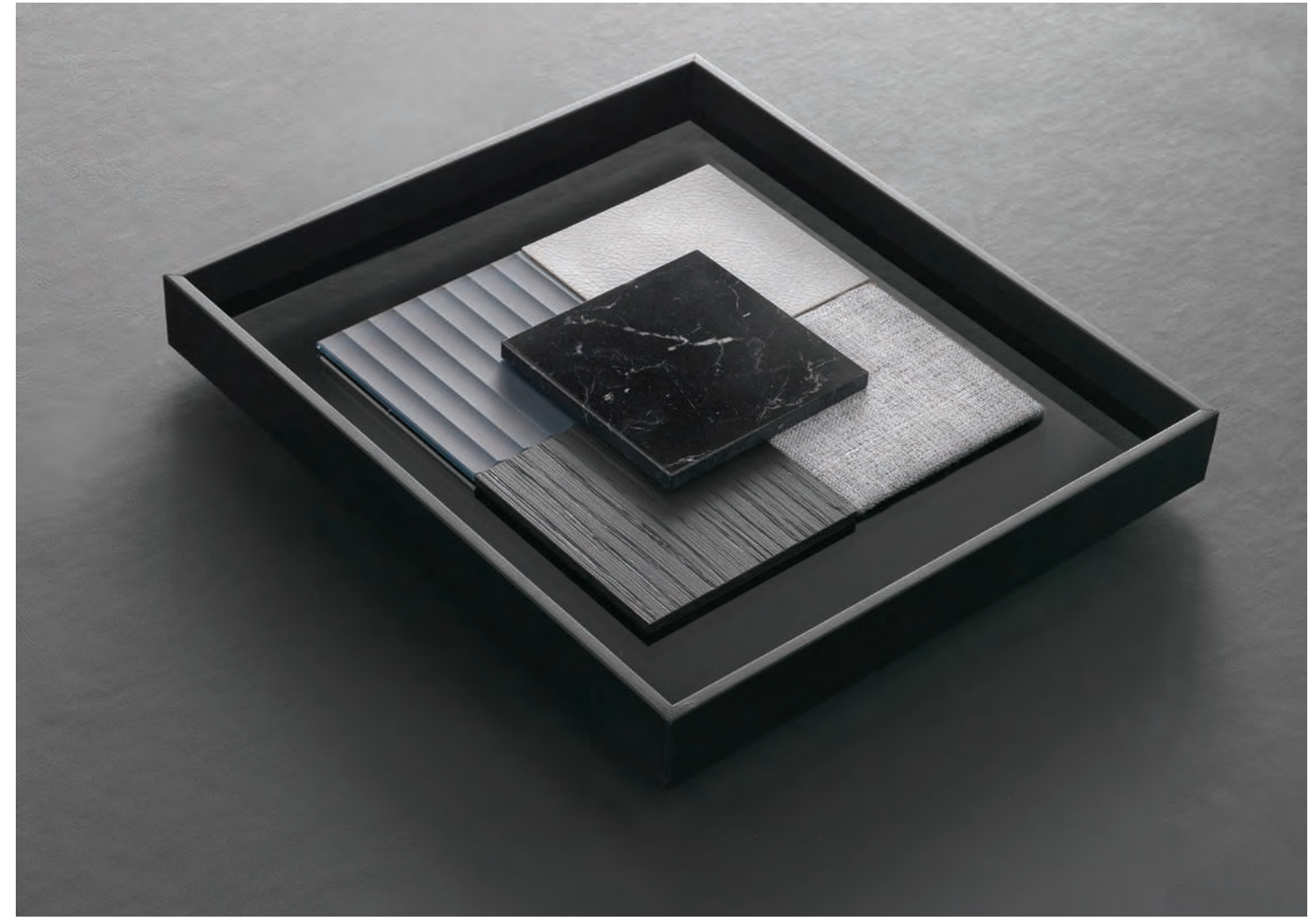

Rimadesio propone sei tavole materiali a cui ispirarsi in fase di progetto attraverso selezionati abbinamenti di vetri, metalli, essenze, tessuti, similpelle, Litech, melaminici e marmi della collezione. Un possibile spunto per definire combinazioni materiche sempre più esclusive, che incontrano il gusto e lo stile unico di ciascun cliente. Realizzate in formato 270x304mm sono asportabili dai cassetti con alloggiamento a incastro.

Rimadesio proposes six material boards to be inspired during the design phase through selected combinations of glass, metals, wood, fabrics, synthetic leather, Litech, melamine and marbles of the collection. A possible starting point to define more and more exclusive material combinations, thus meeting the unique taste and style of each customer. Made in 270x304mm format, they can be removed from the drawers with a snap-in housing.

Rimadesio bietet sechs Materialmuster, die sich während der Designphase durch ausgewählte Kombinationen von Glas, Metallen, Essenzen, Stoffen, Kunstleder, Litech, Melamin und Marmor aus der Kollektion inspirieren lassen. Sie dienen als möglicher Ausgangspunkt, um immer exklusivere Materialkombinationen zu definieren, die dem einzigartigen Geschmack und Stil jedes Kunden gerecht werden. Sie können aus verriegelbaren Schubladen entnommen werden und werden im 270 x 304 mm Format gefertigt.

Rimadesio propose six tableaux de matériaux pour trouver l'inspiration en phase de conception en mariant les verres, métaux, bois, tissus, similicuir, Litech, mélaminés et marbres de la collection. Un point de départ possible pour définir des combinaisons de matières toujours plus exclusives, qui vont à la rencontre du goût et du style unique de chaque client. Réalisés au format 270x304mm ils peuvent être retirés des tiroirs pour une utilisation plus pratique.

Rimadesio propone seis tablas de materiales para inspirarse durante la fase de diseño a través de combinaciones seleccionadas de cristales, metales, maderas, tejidos, simil cuero, Litech, melamina y mármoles de la colección. Un posible punto de partida para definir combinaciones de materiales cada vez más exclusivas que respondan al gusto y estilo únicos de cada cliente. Realizadas en formato 270x304mm, son extraíbles desde los cajones con alojamiento de encastre.

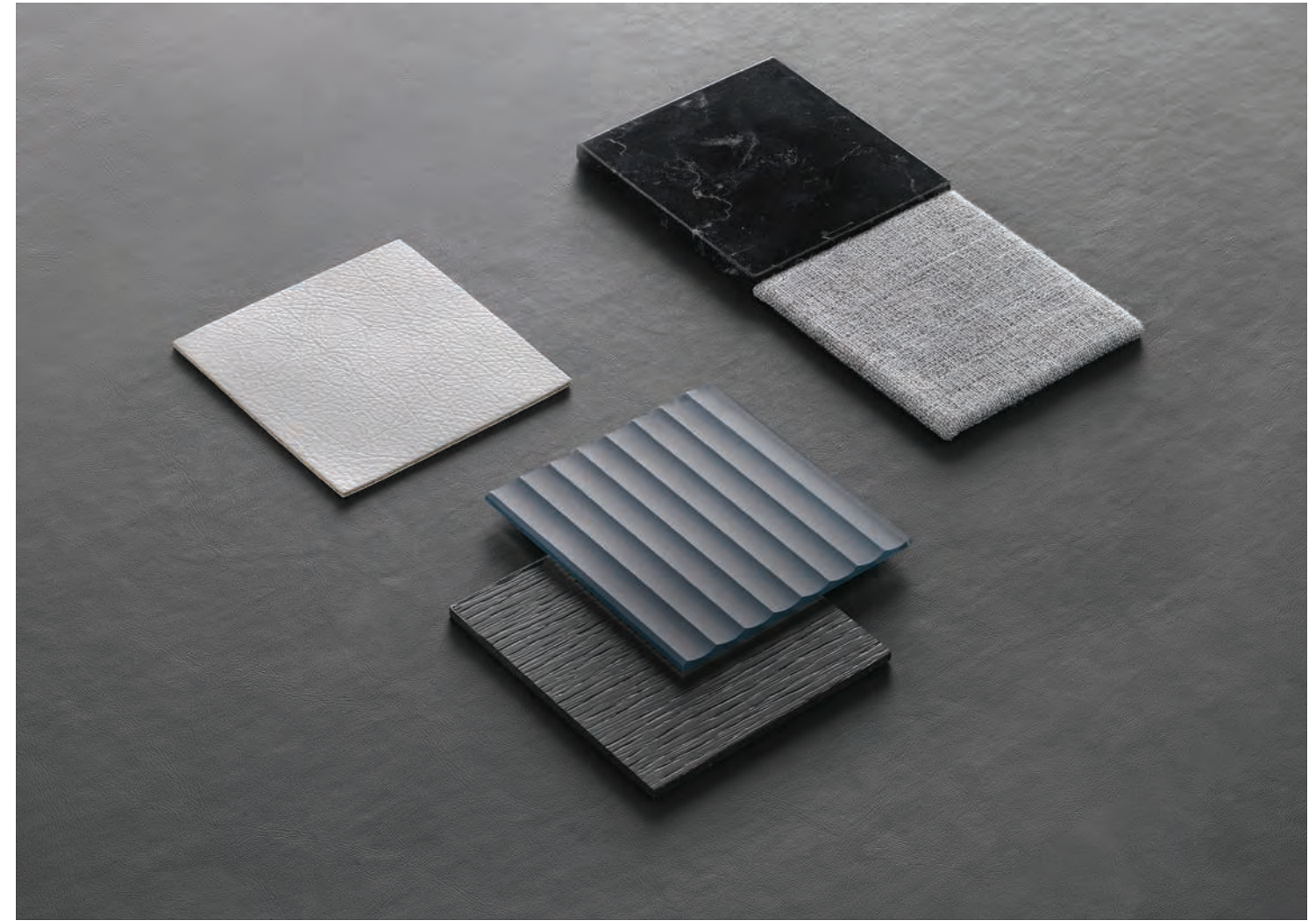

I cassetti inferiori sono specificamente pensati per contenere una scorta di campioni finiture in formato 100x100mm da destinare a professionisti e clienti finali. Il fondo è dotato di un appoggio in gomma morbida per garantire una custodia sicura e ordinata.

The lower drawers are specifically designed to hold a stock of finish samples in 100x100mm format for professionals and end customers. The bottom has a soft rubber pad to ensure a safe and tidy storage.

Die unteren Schubladen sind speziell zur Aufnahme von Veredelungsmustern im Format 100x100mm für Profis und Endkunden konzipiert. Die Unterseite ist mit einer weichen Gummiauflage ausgestattet, um ein sicheres und aufgeräumtes Gehäuse zu gewährleisten.

Les tiroirs inférieurs sont spécialement pensés pour contenir une réserve d'échantillons de finitions en format 100x100mm destinés aux professionnels et aux particuliers. Le fond est doté d'un appui en gomme souple pour assurer une conservation sûre et ordonnée.

Los cajones inferiores están especialmente diseñados para albergar un stock de muestras de acabados en formato 100x100mm para profesionales y clientes finales. El fondo tiene un apoyo de goma suave para garantizar un almacenamiento seguro y ordenado.



Rimadesio offre ai propri Rivenditori la possibilità di acquistare una dotazione supplementare di cataloghi destinati a professionisti e clienti finali.

Rimadesio offers to its dealers the possibility to purchase an additional set of catalogues for professionals and end customers.

Rimadesio bietet seinen Wiederverkäufern die Möglichkeit, zusätzliche Kataloge für Profis und Endkunden zu erwerben.

Rimadesio offre à ses revendeurs la possibilité d'acheter une dotation supplémentaire de catalogues destinés aux professionnels et aux particuliers.

Rimadesio ofrece a sus Distribuidores la posibilidad de adquirir un juego adicional de catálogos destinados a los profesionales y clientes finales.





Display tecnico monofacciale a parete
Wall singlesided technical display

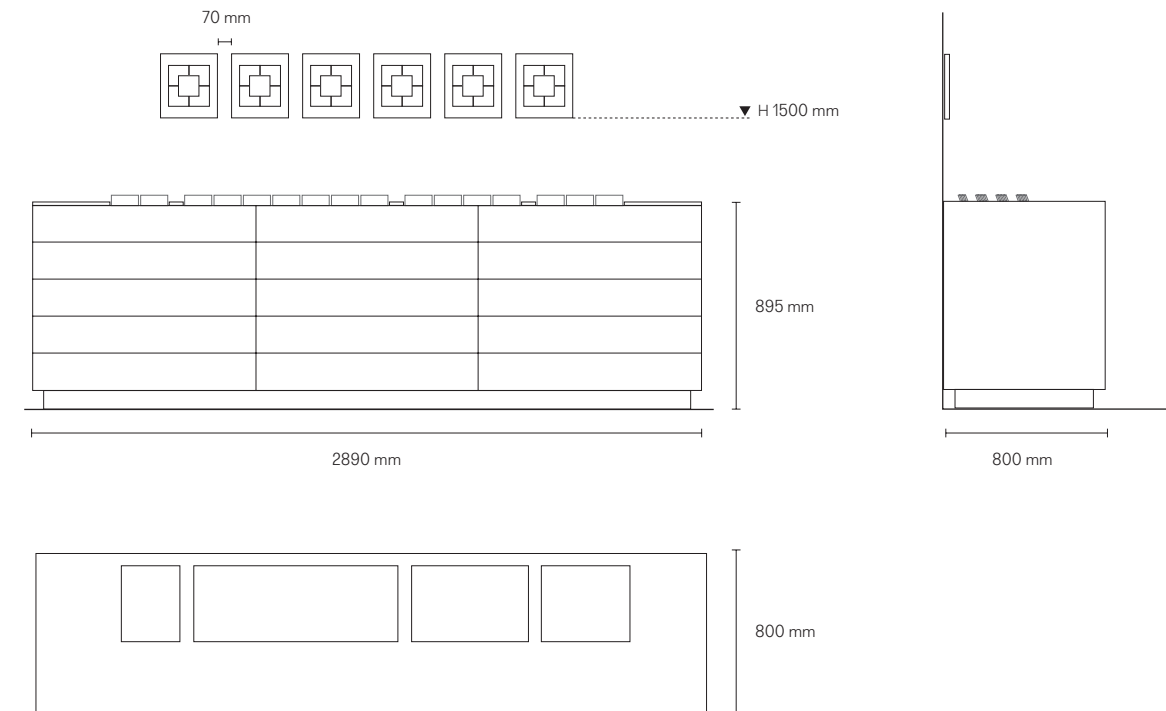

La versione monofacciale è progettata esclusivamente per un posizionamento a parete. Sul piano sono presenti tutte le 258 finiture in collezione. Il display comprende 3 vani a ribalta e 12 cassetti in cui sono alloggiati 23 tavole tecniche e una scorta ordinata di campioni finiture in formato 100x100mm. I material board sono disposti sulla parete in una configurazione lineare.

The single-sided version is designed for wall positioning only. On the top there are all 258 finishes of the collection. The display includes 3 flap compartments and 12 drawers which house 23 technical boards and a tidy stock of finish samples in 100x100mm format. The material boards are arranged on the wall in a linear configuration.

Die Version mit einer Seite ist ausschließlich für eine Wandpositionierung konzipiert. Auf der Oberseite befinden sich alle 258 Oberflächen der Kollektion. Das Display umfasst 3 Klappenfächer und 12 Schubladen, die 23 technischen Schemata und einen geordneten Vorrat an Ausführungsmustern im Format 100x100mm. Die Materialtafeln sind linienförmig an der Wand angeordnet.

La version à une face est conçue uniquement pour un positionnement contre mur. Les 258 finitions de la collection sont toutes présentes sur le plan. Le présentoir comprend 3 meubles abatants et 12 tiroirs dans lesquels sont logés les 23 tableaux techniques et une réserve ordonnée d'échantillons de finitions au format 100x100mm. Les tableaux matériaux sont disposés sur le mur dans une configuration linéaire.

La versión monofacial está diseñada exclusivamente para el montaje en la pared. Los 258 acabados de la colección se encuentran en la parte superior. El expositor incluye 3 compartimentos abatibles y 12 cajones en los que se almacenan 23 tablas técnicas y un stock ordenado de muestras de acabados en formato 100x100mm. Las tablas de material están dispuestas en la pared en una configuración lineal.



Tavole tecniche
Technical boards

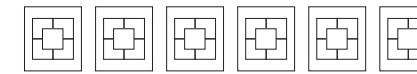

1. Flap door	2. Flap door	3. Flap door
4. MD1 MD2 MD3	5. MD4 MD5 MD6	6. MD7 MD8 MD9
7. TV1 TV2 TV3	8. SZ1 SZ2 SZ3	9. SZ4 SZ5
10. LP1 LP2 AU1	11. MN1 MN2 MN3	12. Samples stock
13. Samples stock	14. Samples stock	15. Samples stock

4. MD1 Modulor adjustable lateral filler	MD2 Modulor terminal profile	MD3 Modulor closing filler or opening passage with fanlight	5. MD4 Modulor terminal closing filler	MD5 Modulor door by pulling for one-side wall paneling	MD6 Modulor door by pushing for double side wall paneling	6. MD7 Modulor internal corner	MD8 Modulor panel for external corner	MD9 Modulor storage
---	------------------------------------	---	---	--	---	--------------------------------------	--	------------------------

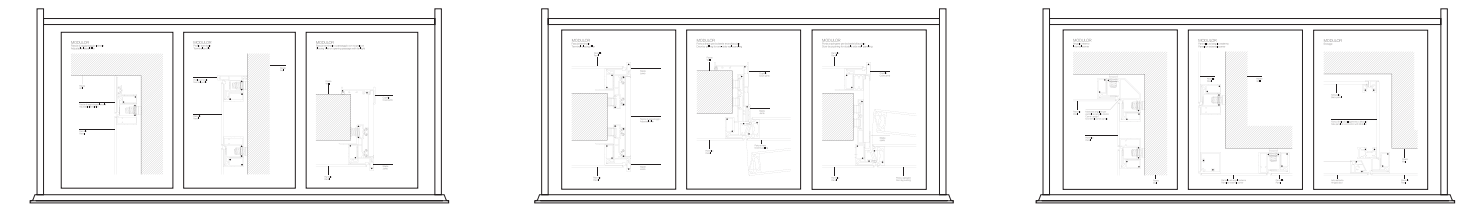

7. TV1 Single wall rail	TV2 Single ceiling rail	TV3 Single built-in rail	8. SZ1 Spazio single profile with fixed panel	SZ2 Spazio single profile with swing door	SZ3 Spazio double profile with fixed panel and sliding door	9. SZ4 Spazio fixed panels with corner joint and T-shaped upright	SZ5 Spazio fixed panel with sliding and swing door
-------------------------------	-------------------------------	--------------------------------	--	--	---	---	---

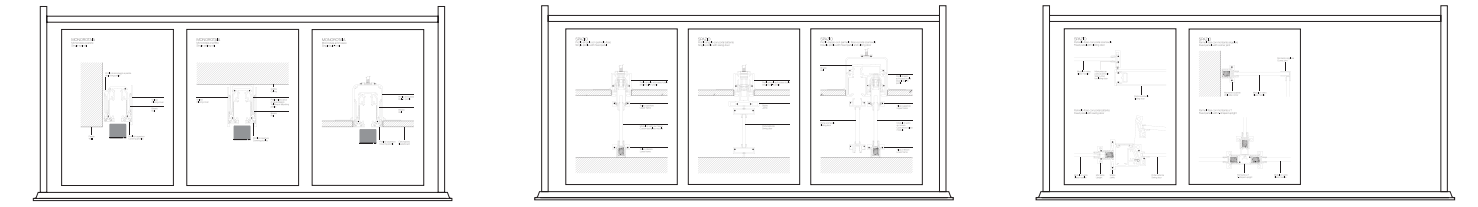

10. LP1 Swing door with standard jamb	LP2 Swing door with slim jamb	AU1 Magnetic double directional door	11. MN1 Swing door with pull and push opening	MN2 Wall flush swing door	MN3 Ceiling flush swing door	12. Samples stock
--	-------------------------------------	--	--	---------------------------------	------------------------------------	-------------------

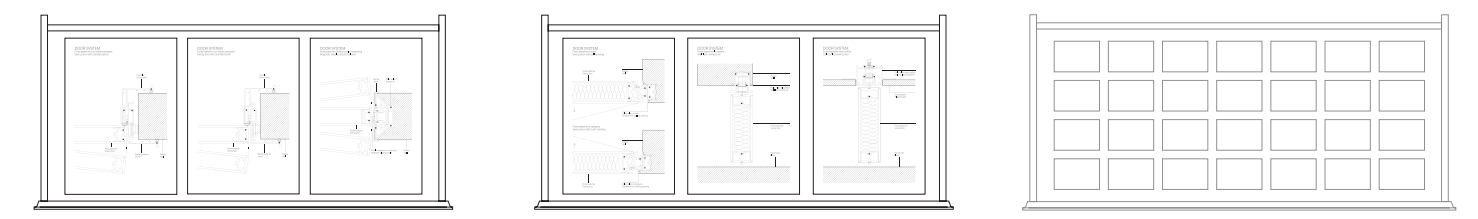

13. Samples stock	14. Samples stock	15. Samples stock
-------------------	-------------------	-------------------

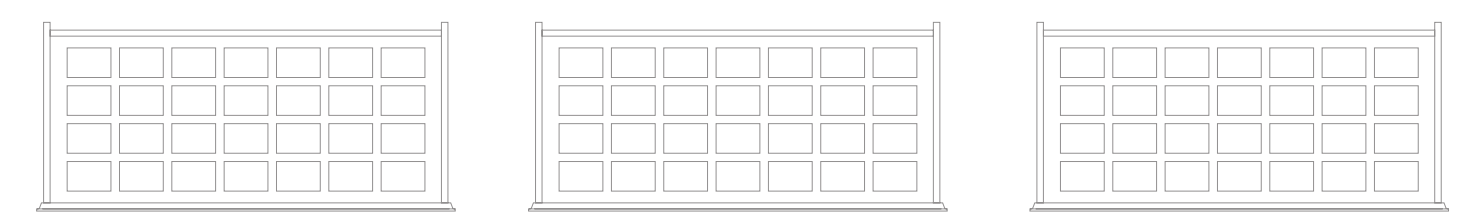



Scorte finiture
Samples stock

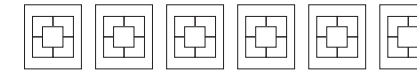

1. Flap door	2. Flap door	3. Flap door
4. MD1 MD2 MD3	5. MD4 MD5 MD6	6. MD7 MD8 MD9
7. TV1 TV2 TV3	8. SZ1 SZ2 SZ3	9. SZ4 SZ5
10. LP1 LP2 AU1	11. MN1 MN2 MN3	12. Samples stock
13. Samples stock	14. Samples stock	15. Samples stock

4. MD1 Modular adjustable lateral filler	MD2 Modular terminal profile	MD3 Modular closing filler or opening passage with fanlight	5. MD4 Modular terminal closing filler	MD5 Modular door by pulling for one-side wall paneling	MD6 Modular door by pushing for double side wall paneling	6. MD7 Modular internal corner	MD8 Modular panel for external corner	MD9 Modular storage panel
---	---------------------------------	--	---	---	--	-----------------------------------	--	------------------------------

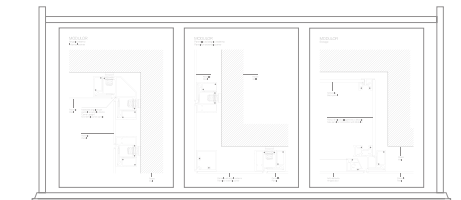
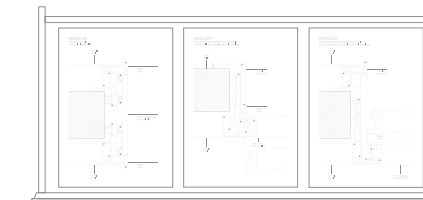
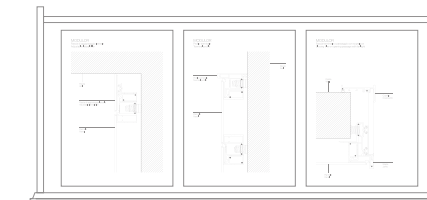

7. TV1 Single wall rail	TV2 Single ceiling rail	TV3 Single built-in rail	8. SZ1 Spazio single profile with fixed panel	SZ2 Spazio single profile with swing door	SZ3 Spazio double profile with fixed panel and sliding door	9. SZ4 Spazio fixed panels with corner joint and T-shaped upright	SZ5 Spazio fixed panel with sliding and swing door
----------------------------	----------------------------	-----------------------------	--	--	--	--	---

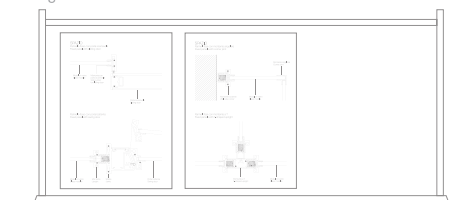
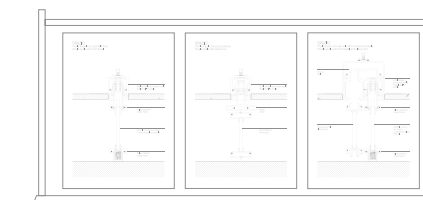
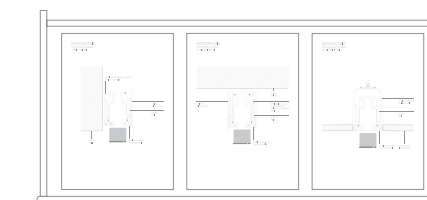

10. LP1 Swing door with standard jamb	LP2 Swing door with slim jamb	AU1 Magnetic double directional door	11. MN1 Swing door with pull and push opening	MN2 Wall flush swing door	MN3 Ceiling flush swing door	12. Samples stock
--	----------------------------------	---	--	------------------------------	---------------------------------	-------------------

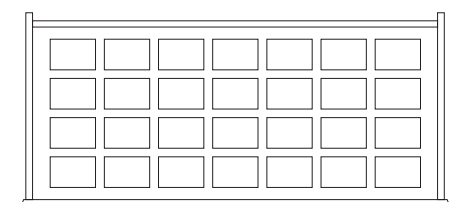
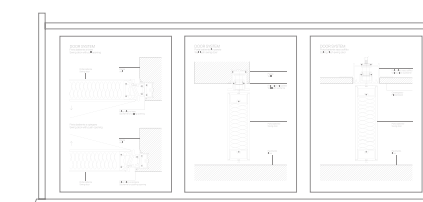
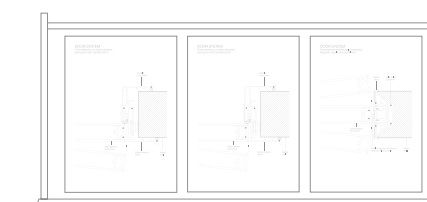

13. Samples stock	14. Samples stock	15. Samples stock
-------------------	-------------------	-------------------

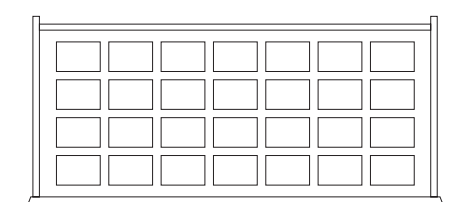
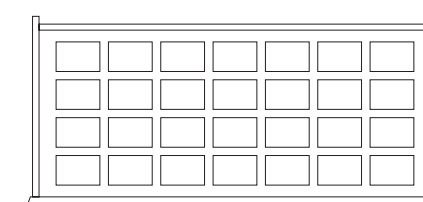
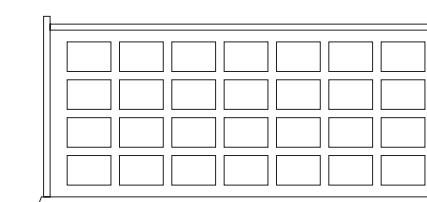



Sei tavole materiali da disporre a parete, per ispirarsi in fase di progetto. Un utile suggerimento su alcuni selezionati abbinamenti tra vetri, metalli, essenze, tessuti, similpelli, melaminici, Litech e marmi della collezione. Uno spunto per la combinazione di nuove composizioni materiche.

Six material boards to be placed on the wall, to be inspired in the design phase. A useful suggestion on some selected combinations of glass, metals, wood, fabrics, synthetic leathers, melamine, Litech and marbles of the collection. A starting point for the combination of new material compositions.

Die Materialschemata sind an der Wand anzubringen und dienen als Inspiration in der Designphase. Sie bieten auch einen nützlichen Vorschlag zu einigen ausgewählten Kombinationen von Glas, Metallen, Essenzen, Stoffen, Kunstleder, Melamin, Litech und Marmor aus der Kollektion und sind ein Ausgangspunkt für die Kombination neuer Materialkompositionen.

Six tableaux matériaux à disposer sur le mur, pour s'inspirer en phase de conception. Une suggestion utile sur certains mariages sélectionnés entre verres, métaux, bois, tissus, similcuirs, mélaminés, Litech et marbres de la collection. Un point de départ pour la combinaison de nouvelles compositions de matériaux.

Seis tablas de materiales para colocar en la pared y dejarse inspirar durante la fase de diseño. Una sugerencia útil sobre algunas combinaciones seleccionadas de cristales, metales, maderas, tejidos, similcueros, melaminas, Litech y mármoles de la colección. Una idea para la combinación de nuevas composiciones de materiales.

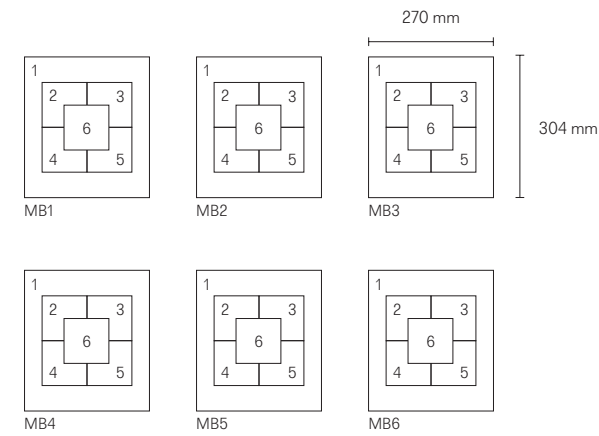

MB1

1. 08 fibra bronzo
2. 15 noce
3. 69 palladio
4. 514 verde lichene sahara
5. 153 castoro
6. 28 calacatta

MB2

1. 63 grigio trasparente
2. 522 blu oceano sahara
3. 158 agata
4. 27 rovere nero
5. T009 piuma
6. 181 nero marquinia

MB3

1. 62 rete bronzo
2. G004 grigio rigato
3. 141 pepe opaco
4. T020 nebbia
5. 206 bronzo graffiato
6. 184 crystal grey

MB4

1. 02 acidato extrachiaro
2. 403 bronzo diamante
3. 17 noce sahara
4. 83 piombo
5. 159 etna
6. G001 crema

MB5

1. 66 maglia gold
2. 303 bronzo
3. 129 amaranto opaco
4. 400 rame diamante
5. 157 arena
6. 182 rosso lepanto

MB6

1. 06 fibra argento
2. 207 platino graffiato
3. 20 rovere termo. sahara
4. 404 platino diamante
5. T052 segale
6. G003 piedra

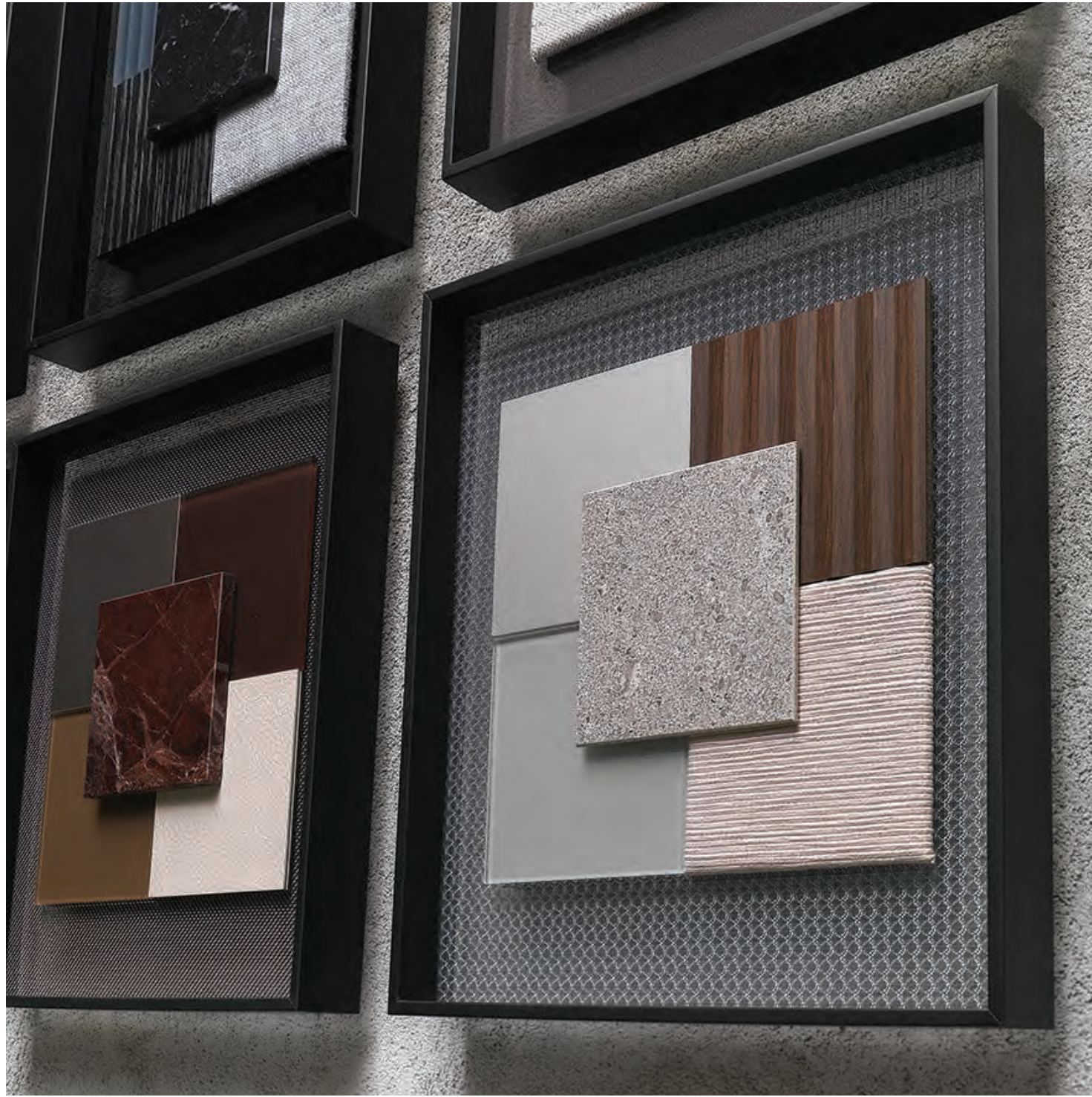

Sono 3 le configurazioni suggerite delle tavole materiali a parete, da scegliere in base allo spazio disponibile.

There are 3 suggested configurations of the wall material boards, to choose from based on available space.

Es gibt 3 Konfigurationsvorschläge der Materialschemas, die je nach verfügbarem Platz ausgewählt werden können.

Les tableaux matériaux muraux suggèrent 3 configurations, à choisir en fonction de l'espace disponible.

Se proponen 3 configuraciones de tablas de materiales murales, a elegir en función del espacio disponible.

Composizione a parete lineare
Linear wall composition

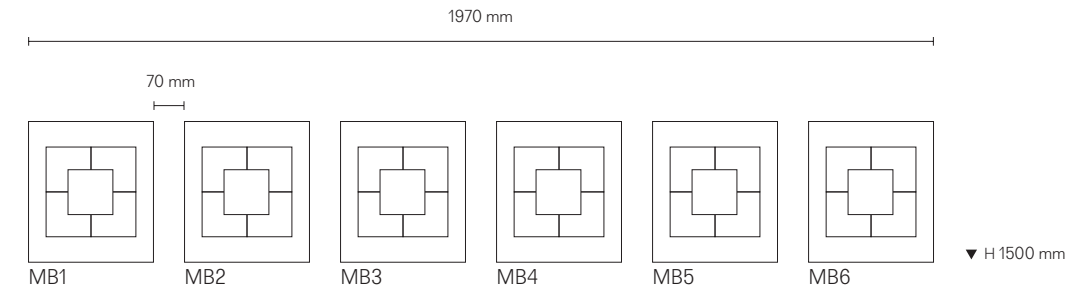

Composizione a parete verticale
Vertical wall composition

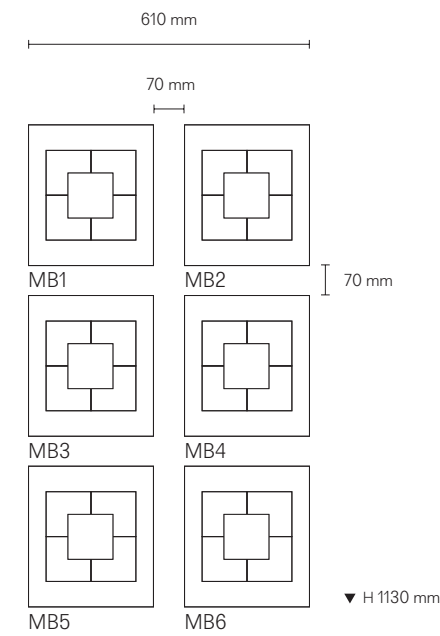

Composizione a parete orizzontale
Horizontal wall composition

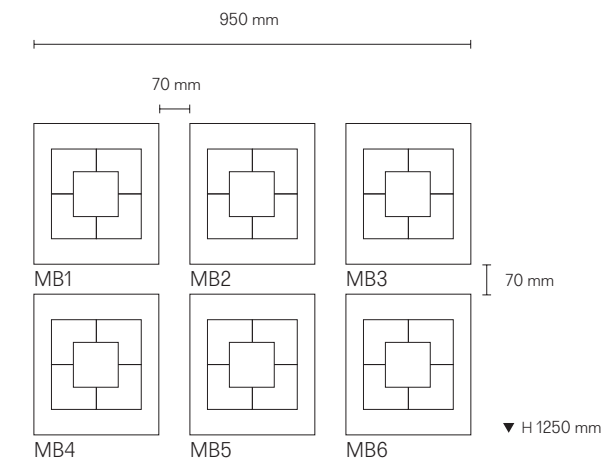

- 64 Segna prodotto, *Nameplates*
- 66 Oggetti di styling, *Styling kit*
- 92 Complementi suggeriti, *Suggested complements*

Rimadesio offre soluzioni stilistiche per i propri spazi espositivi. Uno styling appositamente creato da Rimadesio per comunicare al meglio la propria identità e per valorizzare i propri showroom oltre una selezione di complementi tra i quali lampade, sedie e poltrone; pezzi classici di design in perfetta sintonia con lo stile Rimadesio.

Rimadesio offers stylistic solutions for its exhibition spaces. A styling specifically created by Rimadesio in order to better communicate its identity and to enhance the showrooms through a selection of accessories such as lamps, chairs and armchair; iconic design pieces perfectly aligned with the Rimadesio style.

Rimadesio bietet stylistische Lösungen für seine Ausstellungen. Ein Styling von Rimadesio gedesigt um die Identity der Firma am besten darstellen zu können. Mehrere Ausstellungsstücke wie Lampen, Stühlen und Sesseln; klassische design Stücke die in perfekter Einklang mit Rimadesio Stil stehen.

Rimadesio propose des solutions stylistiques pour ses espaces d'exposition. Un style spécialement créé par Rimadesio pour mieux communiquer son identité et améliorer ses showroom, ainsi qu'une sélection d'accessoires, parmi lesquels des lampes, des chaises et des fauteuils; pièces classiques du design en parfaite harmonie avec le style Rimadesio.

Rimadesio ofrece soluciones estilísticas para sus espacios expositivos. Un estilo creado específicamente por Rimadesio para comunicar mejor su identidad y valorizar sus propios showroom, además de una selección de accesorios que incluyen lámparas, sillas y sillones; piezas clásicas de design en perfecta armonía con el estilo Rimadesio.



1



2

- 1 Segna prodotto in alluminio finitura piombo. Posizionamento a parete a 130 cm da terra.
- 2 Segna prodotto in alluminio finitura piombo. Posizionamento in appoggio.

- 1 Aluminium nameplates in lead finish. Placement on the wall at 130 cm from the floor.
- 2 Aluminium nameplates in lead finish. Layed fixed.

- 1 Nameplatte aus Aluminium, Blei Ausfuehrung. Positionierung an der Wand ab 130 cm vom Boden.
- 2 Nameplatte aus Aluminium, Blei Ausfuehrung. Positionierung in der Unterstuetzung.

- 1 Plaque en aluminium finition plomb. Positionnement au mur à 130 cm du sol.
- 2 Plaque en aluminium finition plomb. A fixer à appuyer.

- 1 Placa producto en aluminio acabado plomo. Colocación en la pared a 130 cm del suelo.
- 2 Placa producto en aluminio acabado plomo. Posiciona y en apoyo.



1



2



3

- 1 Styling kit A: quadro 55x55 cm, scultura in ferro bronzo, scultura in ferro nero, scultura in carta 1.
- 2 Styling kit B: scultura in carta 4, cono in legno, sfera nero lucido ø 14 cm.
- 3 Styling kit C: sfera nero lucido ø 14 cm, scultura in carta 2.

- 1 Styling kit A: picture 55x55 cm, bronze iron sculpture, black iron sculpture, paper sculpture 1.
- 2 Styling kit B: paper sculpture 4, wooden cone, glossy black sphere ø 14 cm.
- 3 Styling kit C: glossy black sphere ø 14 cm, paper sculpture 2.

- 1 Styling kit A: bild 55x55 cm, Skulptur aus Metall in Farbe Kupfer, Skulptur aus Metall in Farbe Schwarz, Skulptur aus Papier 1.
- 2 Styling kit B: skulptur aus Papier 4, Kegel aus Holz, Kugel in Farbe hochglanz Schwarz, ø 14 cm.
- 3 Styling kit C: kugel in Farbe hochglanz Schwarz ø 14 cm, Skulptur aus Papier 2.

- 1 Styling kit A: tableau 55x55 cm, sculpture en fer bronze, sculpture en fer noir, sculpture en papier 1.
- 2 Styling kit B: sculpture en papier 4, cône en bois, boule en noir brillant ø 14 cm.
- 3 Styling kit C: boule en noir brillant ø 14 cm, sculpture en papier 2.

- 1 Styling kit A: cuadro 55x55 cm, escultura en hierro bronce, escultura en hierro negro, escultura en papel 1.
- 2 Styling kit B: escultura en papel 4, cono de madera, esfera negro brillante ø 14 cm.
- 3 Styling kit C: esfera negro brillante ø 14 cm, escultura en papel 2.



1



2

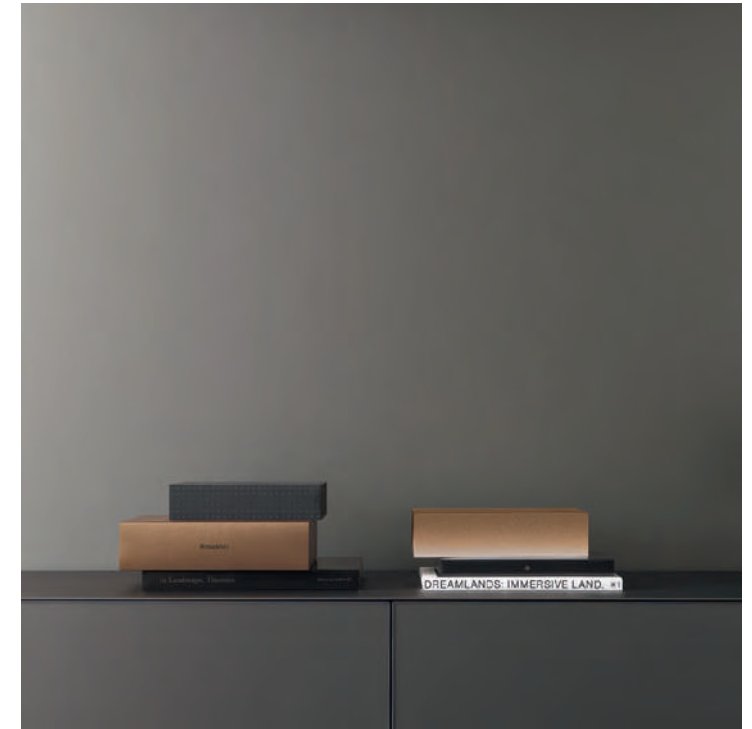

3

- 1 Styling kit N: scultura in carta 3, sfera bronzo opaco ø 14 cm.
- 2 Styling kit D: quadro 50x70 cm, quadro 'cosmo' 40x40 cm, sfera bronzo opaco ø 14 cm, libri orizzontali.
- 3 Libri orizzontali 1, libri orizzontali 2.

- 1 Styling kit N: paper sculpture 3, mat bronze sphere ø 14 cm.
- 2 Styling kit D: picture 50x70 cm, 'cosmos' picture 40x40 cm, mat bronze sphere ø 14 cm, flat layed books 2.
- 3 Flat layed books 1, flat layed books 2.

- 1 Styling kit N: Skulptur aus Papier 3, matt lackierte Kugel in Farbe Kupfer ø 14 cm.
- 2 Styling kit D: bild 50x70 cm, Bild 'Cosmo' 40x40 cm, Matt lackierte Sphaere in Farbe Kupfer ø 14 cm, Horizontale Buecher.
- 3 Horizontale Buecher 1, horizontale Buecher 2.

- 1 Styling kit N: sculpture en papier 3, boule en bronze mat ø 14 cm.
- 2 Styling kit D: tableau 50x70 cm, tableau 'cosmos' 40x40 cm, boule en bronze mat ø 14 cm, groupe de livres horizontaux 2.
- 3 Livres horizontaux 1, livres horizontaux 2.

- 1 Styling kit N: escultura de papel 3, esfera bronce mate ø 14 cm.
- 2 Styling kit D: cuadro 50x70 cm, 'cosmos' cuadro 40x40 cm, esfera bronce mate ø 14 cm, grupo de libros horizontales 2.
- 3 Libros horizontales 1, libros horizontales 2.



1

- 1 Styling kit E: quadro 'luna' 40x40 cm, quadro 90x75 cm, sfera nero lucido ø 20 cm.
- 2 Styling kit G: 6 bicchieri, scultura in carta 2.
- 3 Styling kit F: scultura in carta 5.



2

- 1 Styling kit E: 'moon' picture 40x40 cm, picture 90x75 cm, glossy black sphere ø 20 cm.
- 2 Styling kit G: glasses kit composed by 6 pieces, paper sculpture 2.
- 3 Styling kit F: paper sculpture 5.

- 1 Styling kit E: Bild "mond" 40x40 cm, Bild 90x75 cm, hochglanz lackierte Sphaere in Farbe schwarz ø 20 cm.
- 2 Styling kit G: 6 Gläser, Skulptur aus Papier 2.
- 3 Styling kit F: skulptur aus Papier 5.

- 1 Styling kit E: Tableau "lune" 40x40 cm, tableau 90x75 cm, boule en noir brillant ø 20 cm.
- 2 Styling kit G: 6 pièces verre, sculpture en papier 2.
- 3 Styling kit F: sculpture en papier 5.

- 1 Luna' cuadro 40x40 cm, cuadro 90x75 cm, esfera negro brillante ø 20 cm.
- 2 Styling kit G: 6 Uds. de vasos, escultura de papel 2.
- 3 Styling kit F: escultura de papel 5.



3



1



2

1 Libri bassi 1, libri bassi 2, libri bassi 3, libri bassi 4.
2 Libri alti 1, libri alti 2.

1 Small books 1, small books 2, small books 3, small books 4.
2 Tall books 1, tall books 2.

1 Kleine Buecher 1, Kleine Buecher 2, Kleine Buecher 3, Kleine Buecher 4.
2 Hoehe Buecher 1, hoehe Buecher 2.

1 Livres bas 1, livres bas 2, livres bas 3, livres bas 4.
2 Livres hauts 1, livres hauts 2.

1 Libros pequeños 1, libros pequeños 2, libros pequeños 3, libros pequeños 4.
2 Libros altos 1, libros altos 2.





1

- 1 Styling kit Q: scultura in carta 6, sfera bronzo opaco ø 20 cm.
- 2 Styling kit H: scultura in carta 7, prisma in legno.

- 1 Styling kit Q: paper sculpture 6, mat bronze spher ø 20 cm.
- 2 Styling kit H: paper sculpture 7, wooden prism.

- 1 Styling kit Q: skulptur aus Papier 6, matt lackierte Kugel in Farbe Kupfer, ø 20 cm.
- 2 Styling kit H: skulptur aus Papier 7, Prisma aus Holz.

- 1 Styling kit Q: sculpture en papier 6, prisma en bois, boule en bronze mat ø 20 cm.
- 2 Styling kit H: sculpture en papier 7, prisma en bois.

- 1 Styling kit Q: escultura de papel 6, prisma de madera, esfera bronzo mate ø 20 cm.
- 2 Styling kit H: escultura de papel 7, prisma de madera.



2

Oggetti di styling, *Styling kit*



2

- 1 Styling kit P: sfera nero lucido ø 20 cm, sfera bronzo opaco ø 14 cm.
- 2 Styling kit M: cono in legno, sfera nero lucido ø 14 cm.
- 3 Styling kit L: quadro 'righe' 40x40 cm, scultura in carta 4, sfera nero lucido ø 14 cm, sfera bronzo opaco ø 20 cm.

- 1 Styling kit P: glossy black sphere ø 20 cm, mat bronze sphere ø 14 cm.
- 2 Styling kit M: wooden cone, glossy black sphere ø 14 cm.
- 3 Styling kit L: 'stripes' picture 40x40 cm, paper sculpture 4, glossy black sphere ø 14 cm, mat bronze sphere ø 20 cm.

- 1 Styling kit P: Skulptur aus Papier 4, Kugel in Farbe hochglanz Schwarz ø 20 cm, matt lackierte Kugel in Farbe Kupfer ø 14 cm.
- 2 Styling kit M: Kegel aus Holz, Kugel in Farbe hochglanz Schwarz ø 14 cm.
- 3 Styling kit L: Bild 'mit Zeilen' 40x40 cm, Skulptur aus Papier 4, Kugel in Farbe hochglanz Schwarz ø 14 cm, matt lackierte Kugel in Farbe Kupfer ø 20 cm.

- 1 Styling kit P: boule en noir brillant ø 20 cm, boule en bronze mat ø 14 cm.
- 2 Styling kit M: cône en bois, boule en noir brillant ø 14 cm.
- 3 Styling kit L: tableau 'rayé' 40x40 cm, sculpture en papier 4, boule en noir brillant ø 14 cm, boule en bronze mat ø 20 cm.

- 1 Styling kit P: esfera negro brillante de ø 20 cm, esfera bronce mate de ø 14 cm.
- 2 Styling kit M: cono de madera, esfera negro de ø 14 cm.
- 3 Styling kit L: cuadro 'rayas' de 40x40 cm, escultura de papel 4, esfera negro brillante de ø 14 cm, esfera bronce mate de ø 20 cm.



3



1



2



3



1 Tappeto disponibile in due dimensioni: 200x300 cm, 250x300 cm.

1 Carpet available in two dimensions: 200x300 cm, 250x300 cm.

1 Teppich in 2 Grösse erhältlich 200x300 cm, 250x300 cm.

1 Tapis disponible en deux dimensions: 200x300 cm, 250x300 cm.

1 Alfombra disponible en dos tamaños: 200x300 cm, 250x300 cm.

2 Tappeto disponibile in una dimensione Ø 250 cm.

2 Carpet available in one dimension: Ø 250 cm.

2 Teppich in Einheitsgröße erhältlich: Ø 250 cm.

2 Tapis disponible en une dimension: Ø 250 cm.

2 Alfombra disponible en un tamaño: Ø 250 cm.

3 Sgabello disponibile nella variante a base quadrata oppure tonda.

3 Wooden stool available in the square or round version.

3 Hocker erhältlich mit viereckiger Basis oder mit runder Basis.

3 Tabouret disponible en version à base carrée ou ronde.

3 Taburete disponible en la variante con base cuadrada o redonda.

Finiture tappeti
Carpets finishings

200x300 cm / 250x300 cm



white



taupe



platinum

Ø 250 cm



champagne



1



2

- 1 Styling kit O: cappelliera bassa, cappelliera alta, sfera bronzo opaco ø 14 cm.
- 2 Scatole 1, scatole 2.

- 1 Styling kit O: small hat box, tall hat box, mat bronze sphere ø 14 cm.
- 2 Boxes 1, boxes 2.

- 1 Styling kit O: niedrige Hutschachtel, hoehe Hutschachtel, Kugel in Farbe Kupfer matt ø 14 cm.
- 2 Schachtel 1, Schachtel 2.

- 1 Styling kit O: carton bas à chapeaux, carton haut à chapeaux, boule en bronze mat ø 14 cm.
- 2 Boites 1, boites 2.

- 1 Styling kit O: sombrero baja, sombrero alta, esfera bronze mate ø 14 cm.
- 2 Grupo cajas 1, grupo cajas 2.





1

- 1 Vassoio in similpelle disponibile in 7 colori. Styling Kit V: 2 cravatte in carta.
- 2 Styling kit I: quadro 'cosmo' 40x40 cm, quadro 50x70 cm, sfera bronzo opaco ø 14 cm, scultura tonda in ferro nero.
- 3 Camicia in carta.

- 1 Synthetic leather tray available in 7 finishes. Styling Kit V: 2 paper ties.
- 2 Styling kit I: 'cosmos' picture 40x40 cm, picture 50x70 cm, mat bronze sphere ø 14 cm, black iron round sculpture.
- 3 Paper shirt.

- 1 Behälter aus Kunstleder in 7 Ausführungen erhältlich. Styling Kit V: 2 Krawatten aus Papier.
- 2 Styling kit I: bild 'cosmo' 40x40 cm, Bild 50x70 cm, Kugel matt Kupfer ø 14 cm, Schwarze runde Skulptur aus Metall.
- 3 Hemd aus Papier.

- 1 Plateau en similicuir disponible en 7 finitions. Styling Kit V: cravates en papier.
- 2 Styling kit I: tableau 'cosmos' 40x40 cm, tableau 50x70 cm, boule en bronze mat ø 14 cm, sculpture ronde en fer noir.
- 3 Chemise en papier.

- 1 Bandeja de simil cuero disponible en 7 acabados. Styling Kit V: 2 corbata en papel.
- 2 Styling kit I: 'cosmos' cuadro 40x40 cm, cuadro 50x70 cm, esfera bronce mate de ø 14 cm, escultura redonda de hierro negro.
- 3 Camiseta en papel.



2



3



1

- 1 Pantaloni in carta.
- 2 Gruccia in legno.
- Abito lungo in carta.
- Abito corto in carta.



2

- 1 Paper trousers.
- 2 Wooden coat hanger.
- Paper long dress.
- Paper short dress.

- 1 Hosen aus Papier.
- 2 Kleiderbugel aus Holz.
- Langes Kleid aus Papier.
- Kurzes Kleid aus Papier.

- 1 Pantalon en papier.
- 2 Cintres en bois.
- Robe longue en papier.
- Robe courte en papier.

- 1 Pantalones en papel.
- 2 Perchas en madera.
- Vestido largo en papel.
- Vestido corto en papel.





1



2



3



- 1 Cesta in simipelle disponibile in 7 colori.
- 2 Scarpe in carta.
- 3 Styling kit T: kit accessori in carta per vassoio estraibile organizer.

- 1 Box in synthetic leather available in 7 finishes.
- 2 Paper shoes.
- 3 Styling kit T: paper accessories kit for pull out organizer tray

- 1 Kunstlederkorb erhältlich in 7 Farben.
- 2 Schuhe aus Papier.
- 3 Styling Kit T: Kit Accessoires aus Papier für Ausziehleder organizer.

- 1 Panier en similicuir disponible en 7 couleurs.
- 2 Chaussures en papier.
- 3 Styling kit T: Kit accessoires en papier pour étagère organizer à extraire.

- 1 Cesta de símil cuero disponible en 7 colores.
- 2 Zapatos en papel.
- 3 Styling kit T: kit de accesorios de papel para la bandeja organizadora extraíble.



1

- 1 Styling kit R: kit accessori in carta per vassoio estraibile uomo.
- 2 Styling kit S: kit accessori in carta per vassoio estraibile donna.

- 1 Styling kit R: paper accessories kit for man pull out shelf.
- 2 Styling kit S: paper accessories kit for woman pull out shelf.

- 1 Styling Kit R: Kit Accessoires aus Papier für Herren.
- 2 Styling Kit S: Kit Accessoires aus Papier für Frauen.

- 1 Styling kit R: kit accessoires en papier pour étagère à extraire version homme.
- 2 Styling kit S: accessoires en papier pour étagère à extraire version femme.

- 1 Styling kit R: kit de accesorios en papel para bandeja extraible hombre.
- 2 Styling kit S: kit de accesorios en papel para bandeja extraible mujer.



2

Complementi suggeriti
Suggested complements

Lampade da sospensione *Suspended lamps*

Arrangements, Flos
Overlap, Flos
Alexandra, Pallucco
Taraxacum, Flos
Palla, Vesoi
2097, Flos

Lampade da terra *Floor lamps*

Akari Uf3, Vitra
Spun Light, Flos
IC Lights Floor 1, Flos
Superloon, Flos
Luminator, Flos
Pascal, Oluce

Lampade da tavolo *Table lamps*

Copycat, Flos
Aj, Louis Poulsen
Dioscuri, Artemide
Taccia, Flos
Gatto, Flos
Aoy, Flos
Atollo, Oluce

Sedie *Chairs*

CH33, Carl Hansen & Søn
CH24, Carl Hansen & Søn
CH20, Carl Hansen & Søn

Poltrone *Lounge chairs*

CH07, Carl Hansen & Søn
CH25, Carl Hansen & Søn
CH445, Carl Hansen & Søn

Pouf

Cilindro, Azucena

Lampade da sospensione *Suspended lamps*



Arrangements, Flos



Overlap, Flos

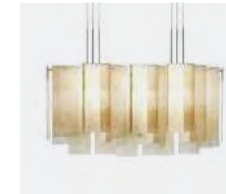

Alexandra, Pallucco



Taraxacum, Flos

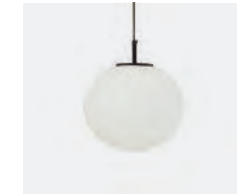

Palla, Vesoi



2097, Flos

Lampade da terra *Floor lamps*

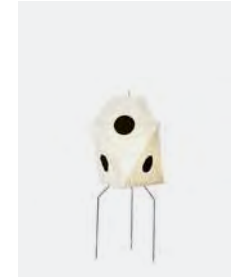

Akari Uf3, Vitra



Spun Light, Flos



IC light floor 1, Flos



Superloon, Flos



Luminator, Flos



Pascal, Oluce

Lampade da tavolo *Table lamps*



Aj, Louis Poulsen

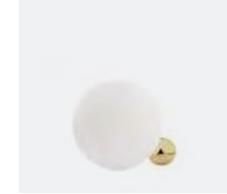

Copycat, Flos



Taccia, Flos



Aoy, Flos



Gatto, Flos

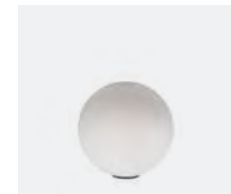

Dioscuri, Artemide



Atollo, Oluce

Poltrone *Lounge chairs*



CH25, Carl Hansen & Søn



CH07, Carl Hansen & Søn

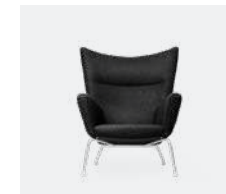

CH445, Carl Hansen & Søn

Sedie *Chairs*



CH33, Carl Hansen & Søn



CH24, Carl Hansen & Søn



CH20, Carl Hansen & Søn

Pouf

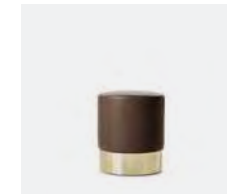

Cilindro, Azucena

94 Zona giorno, *Living area*
158 Zona notte, *Night area*

Proposte espositive, *Exhibition proposals*



Rimades

Finiture
Finishings

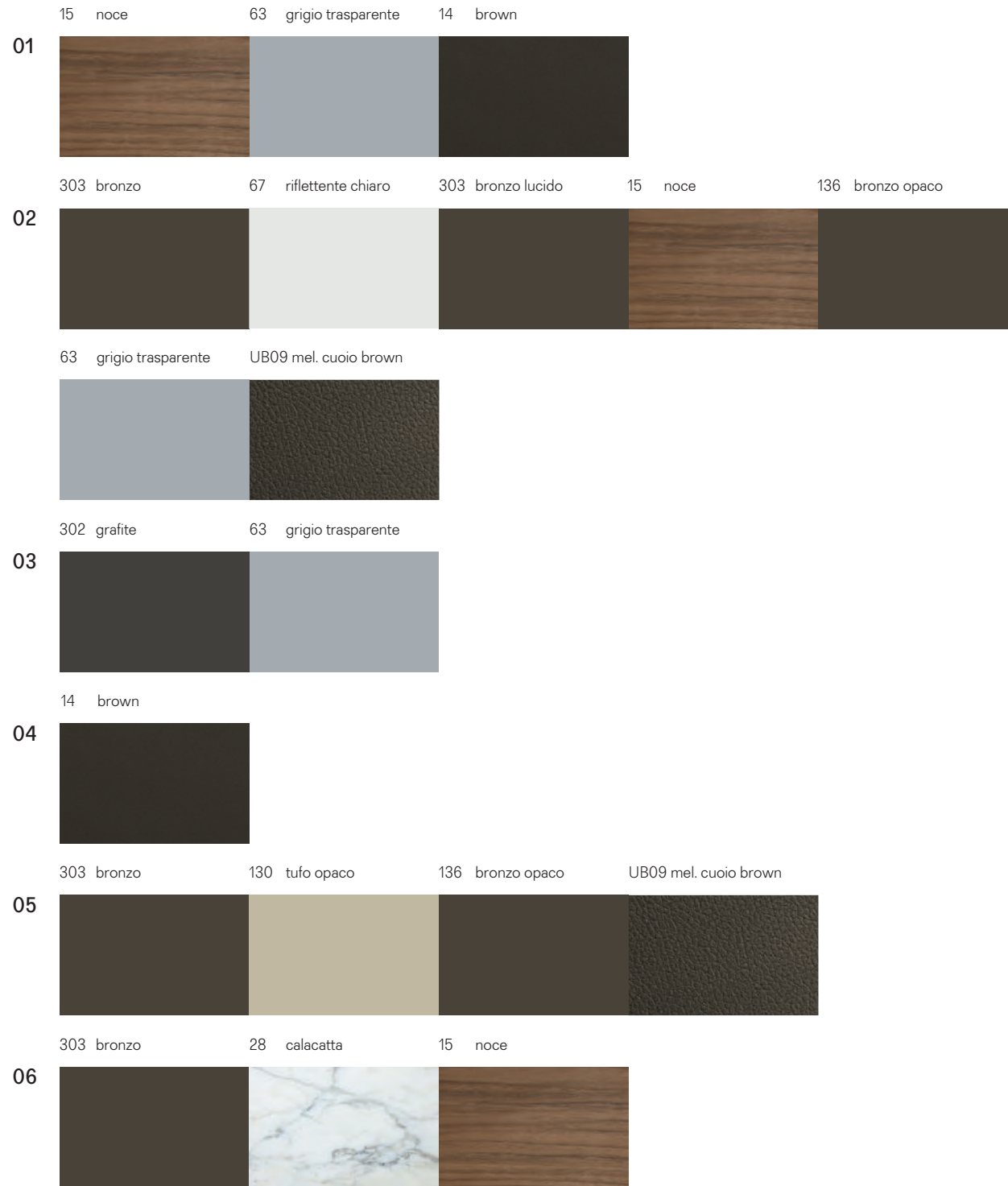

Pianta
Plan

Prodotti
Products

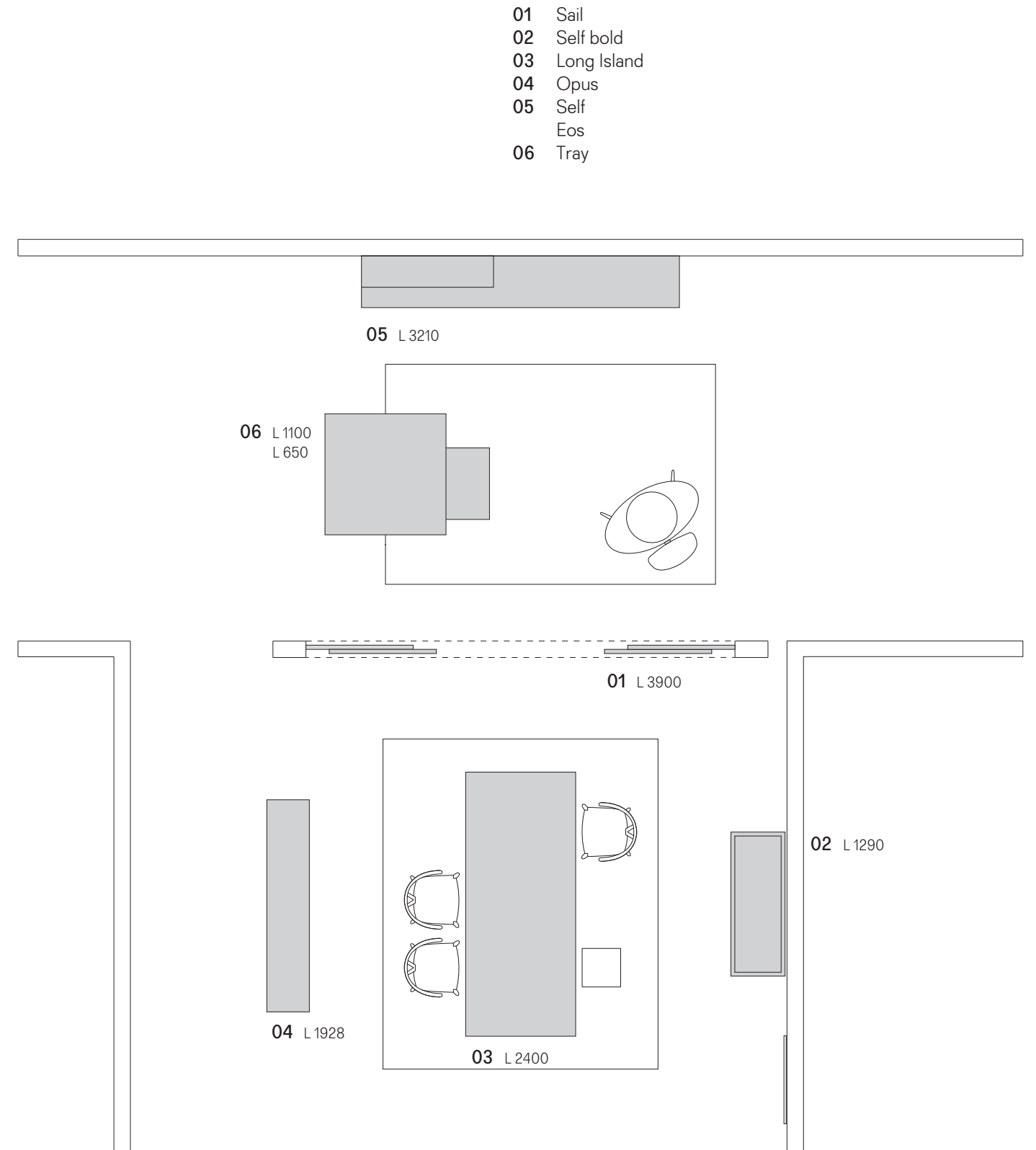



Rimadesio

Finiture
Finishings

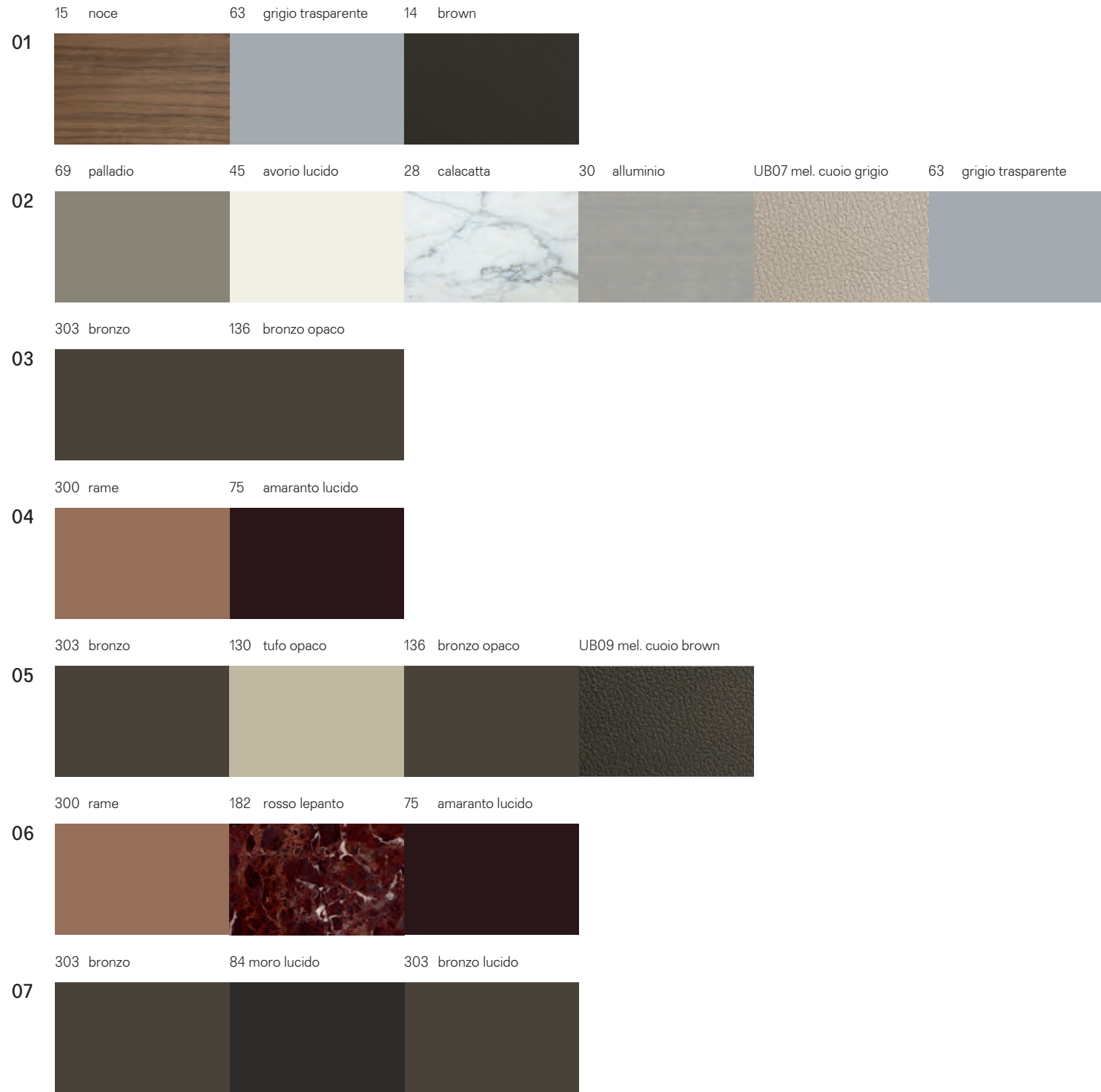

Pianta
Plan

Prodotti
Products

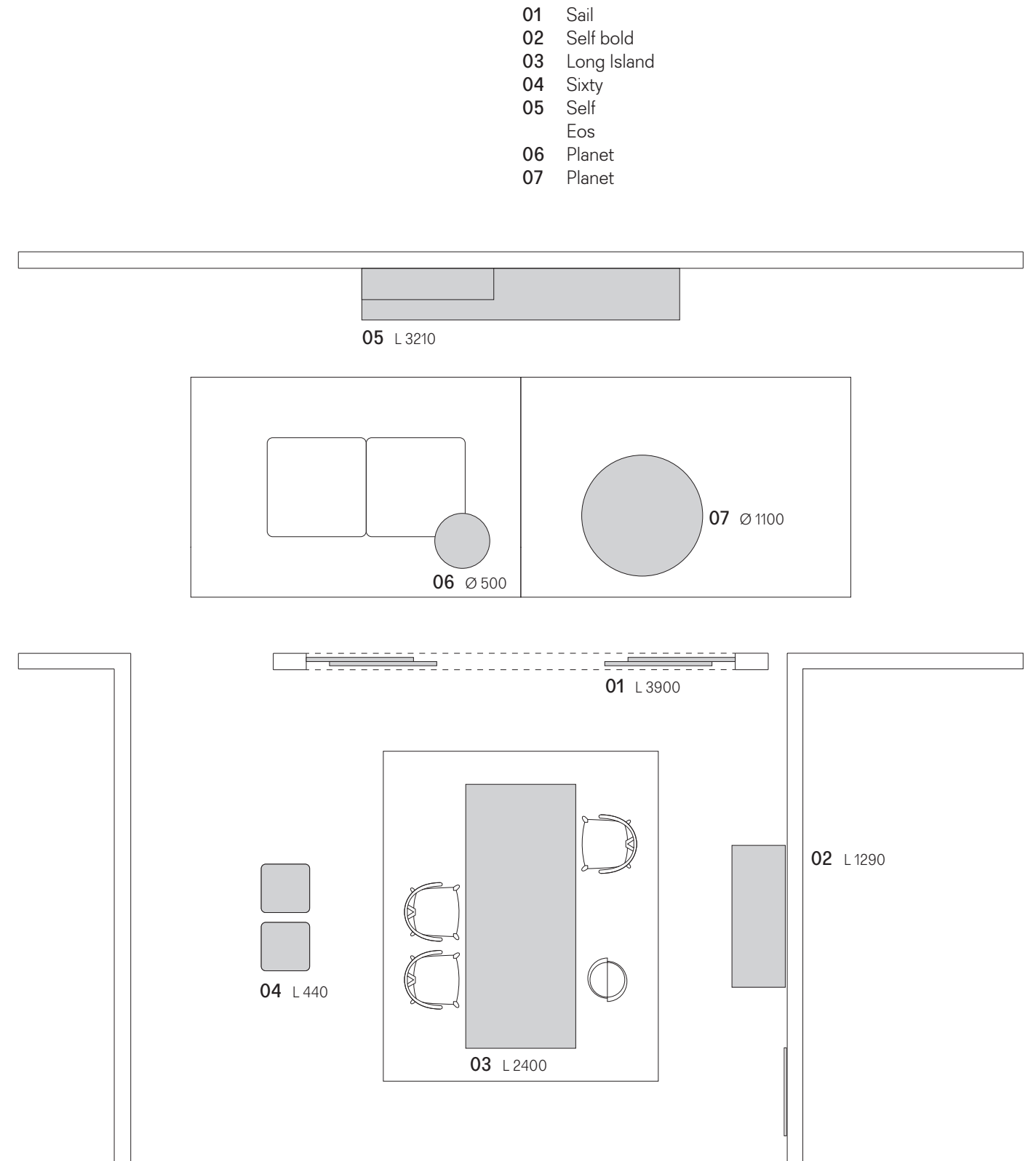



Rimadesio

Finiture
Finishings

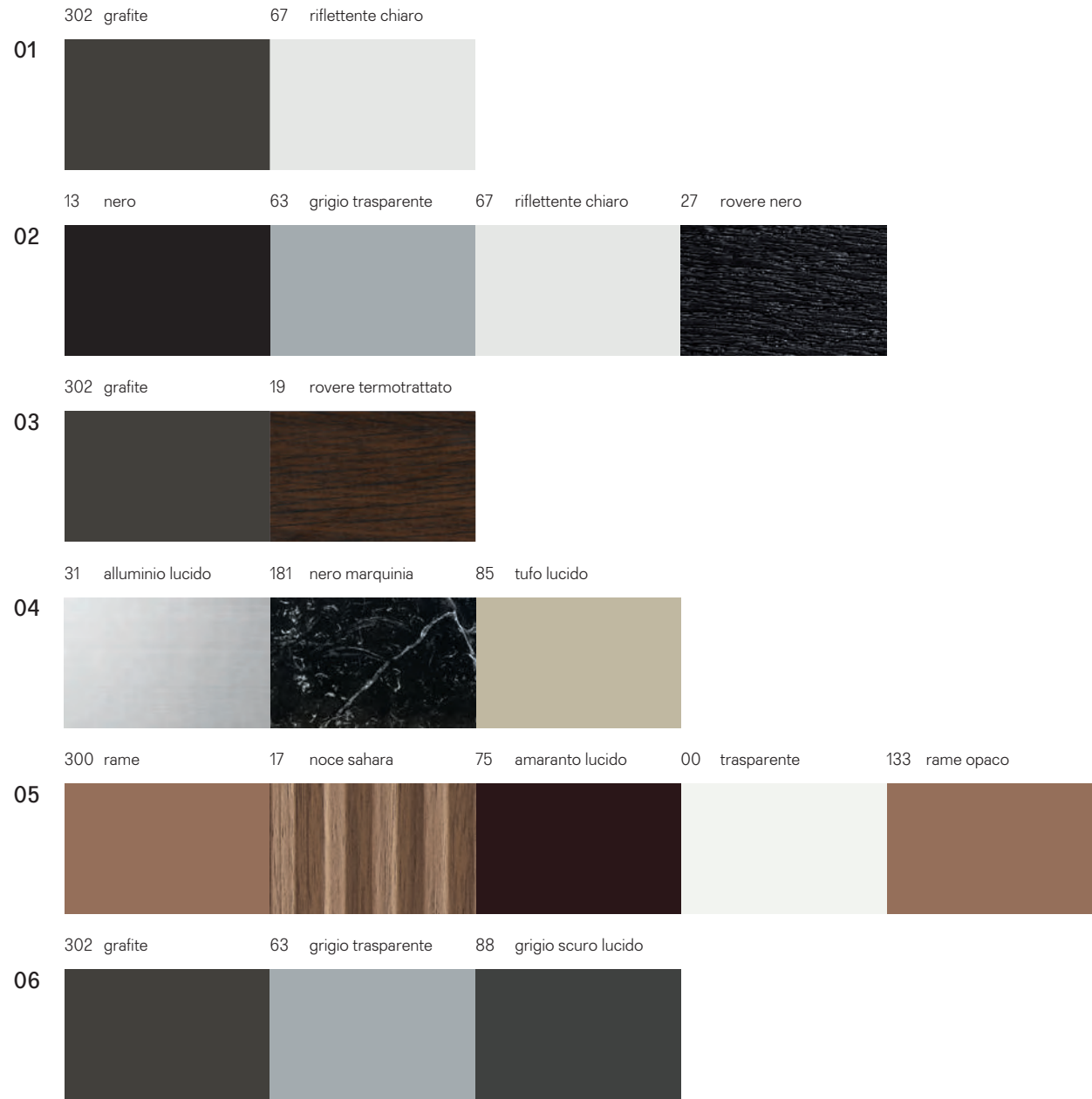

Pianta
Plan

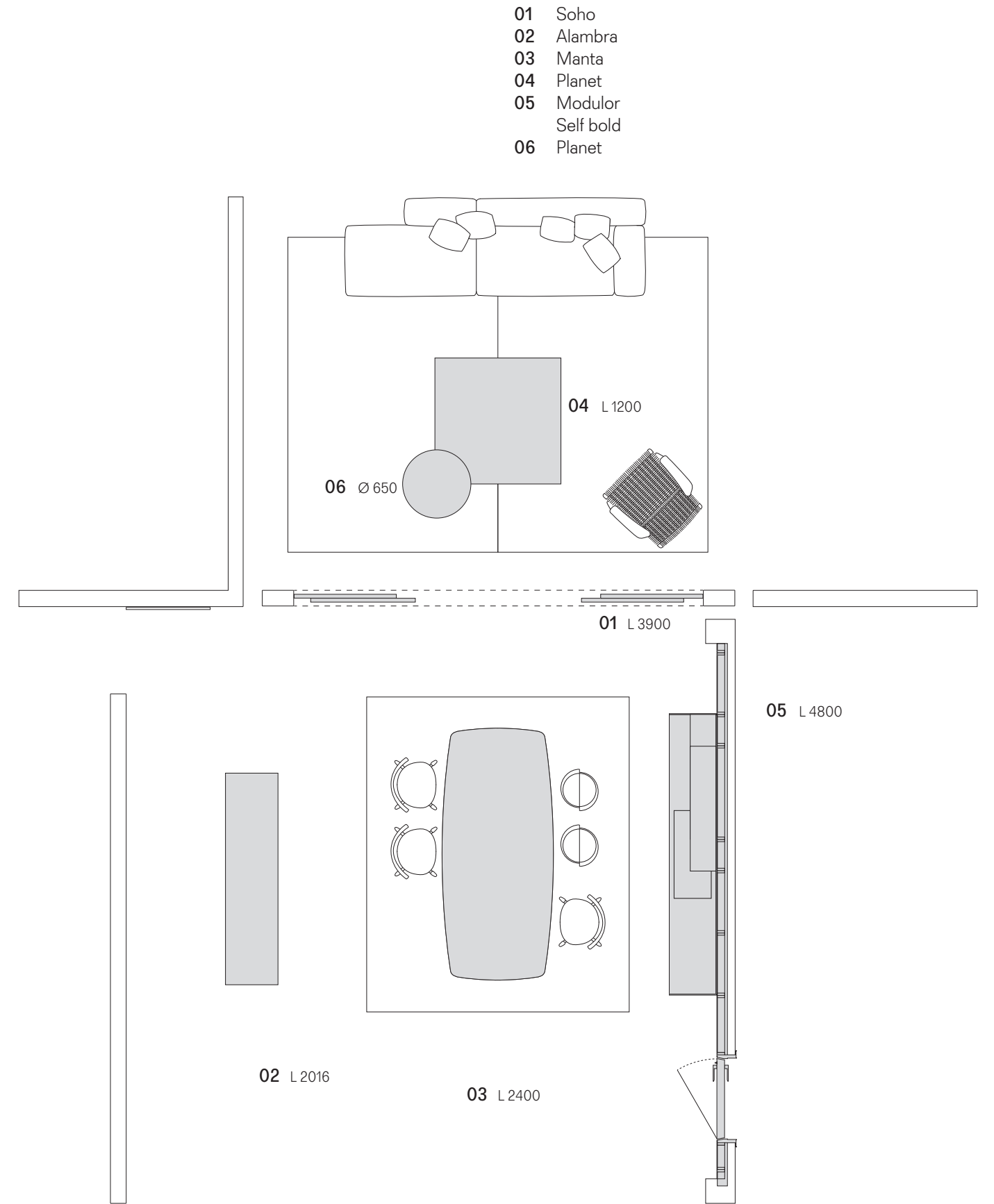



Finiture
Finishings

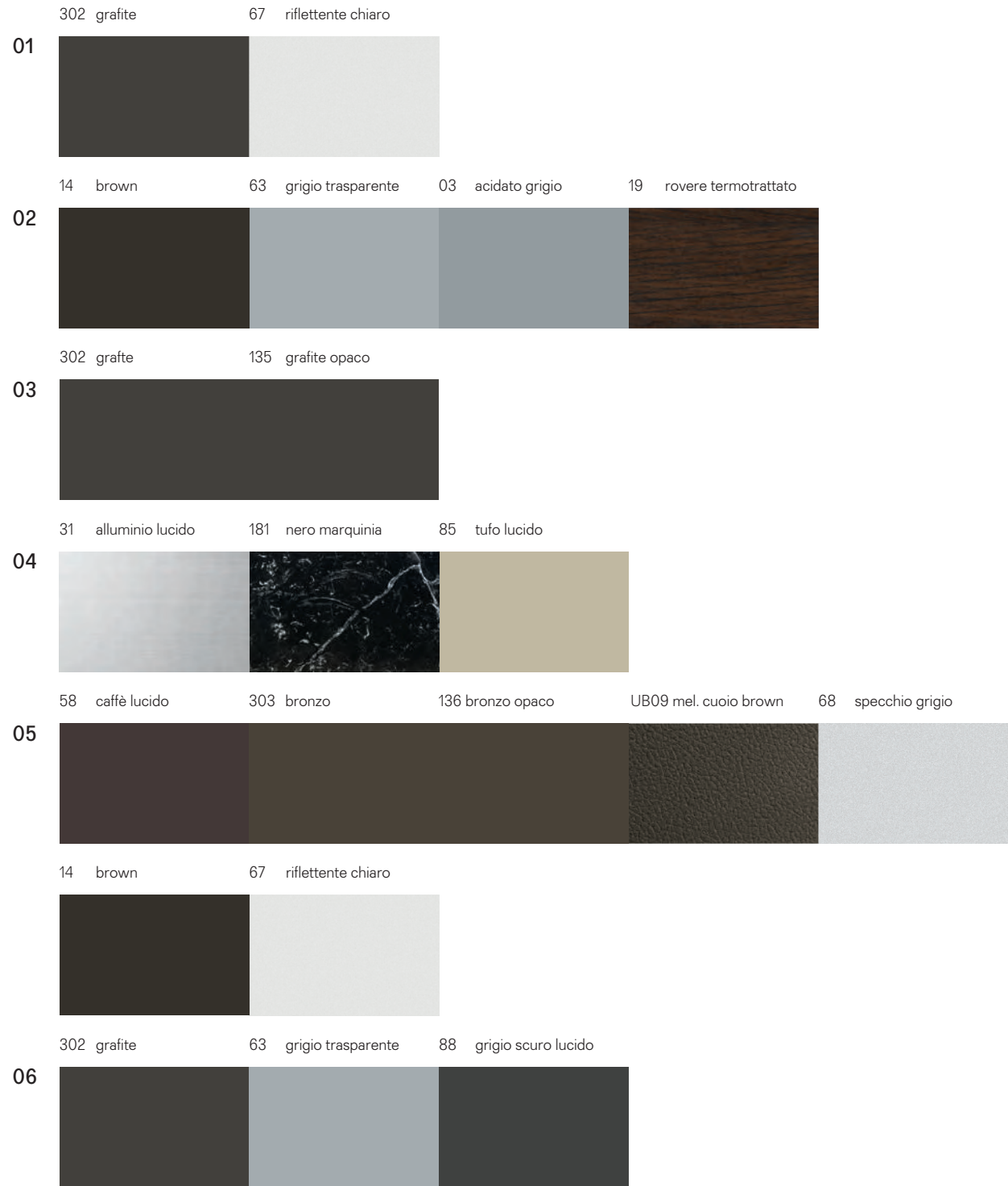

Pianta
Plan

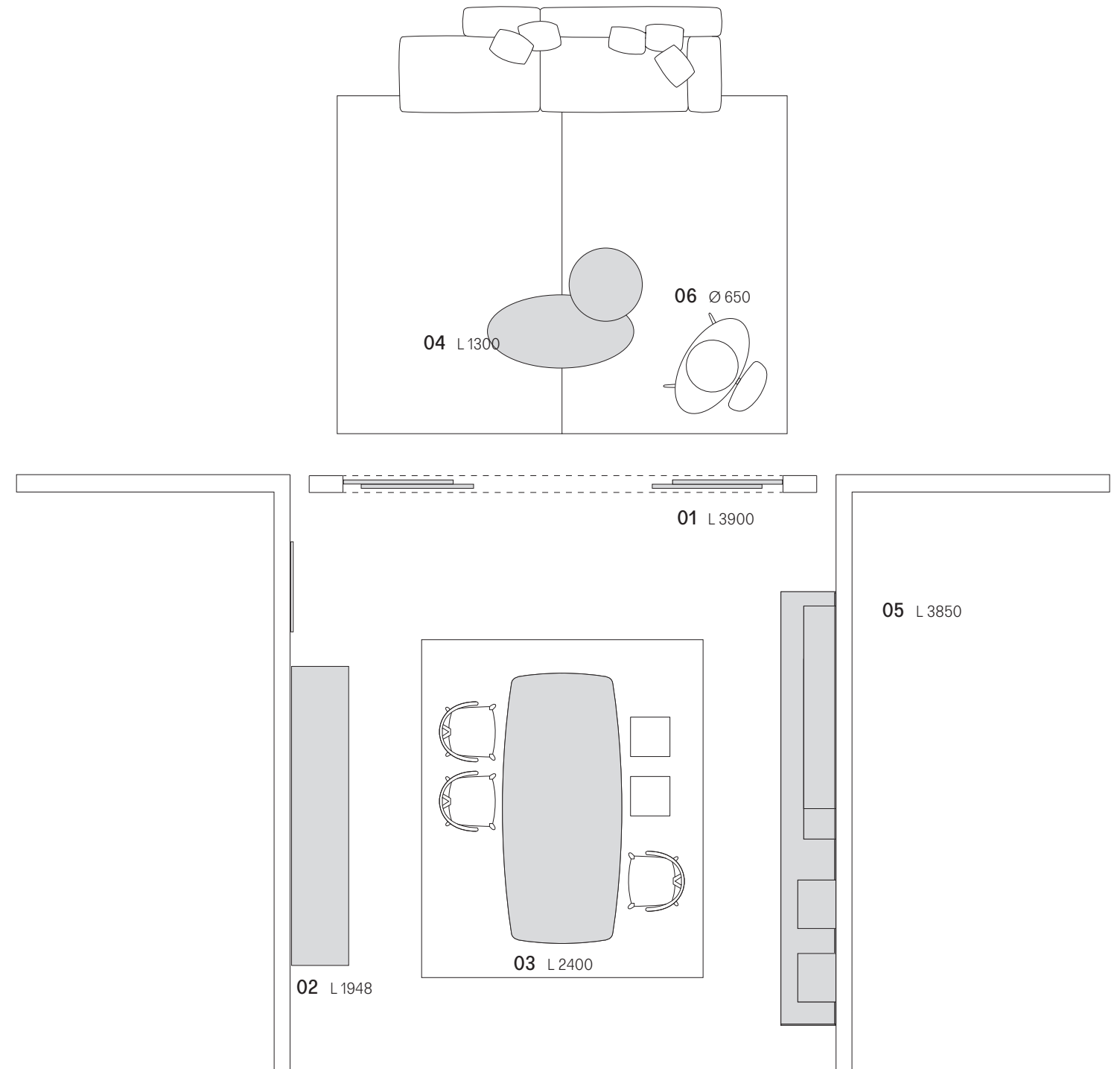



Finiture
Finishings

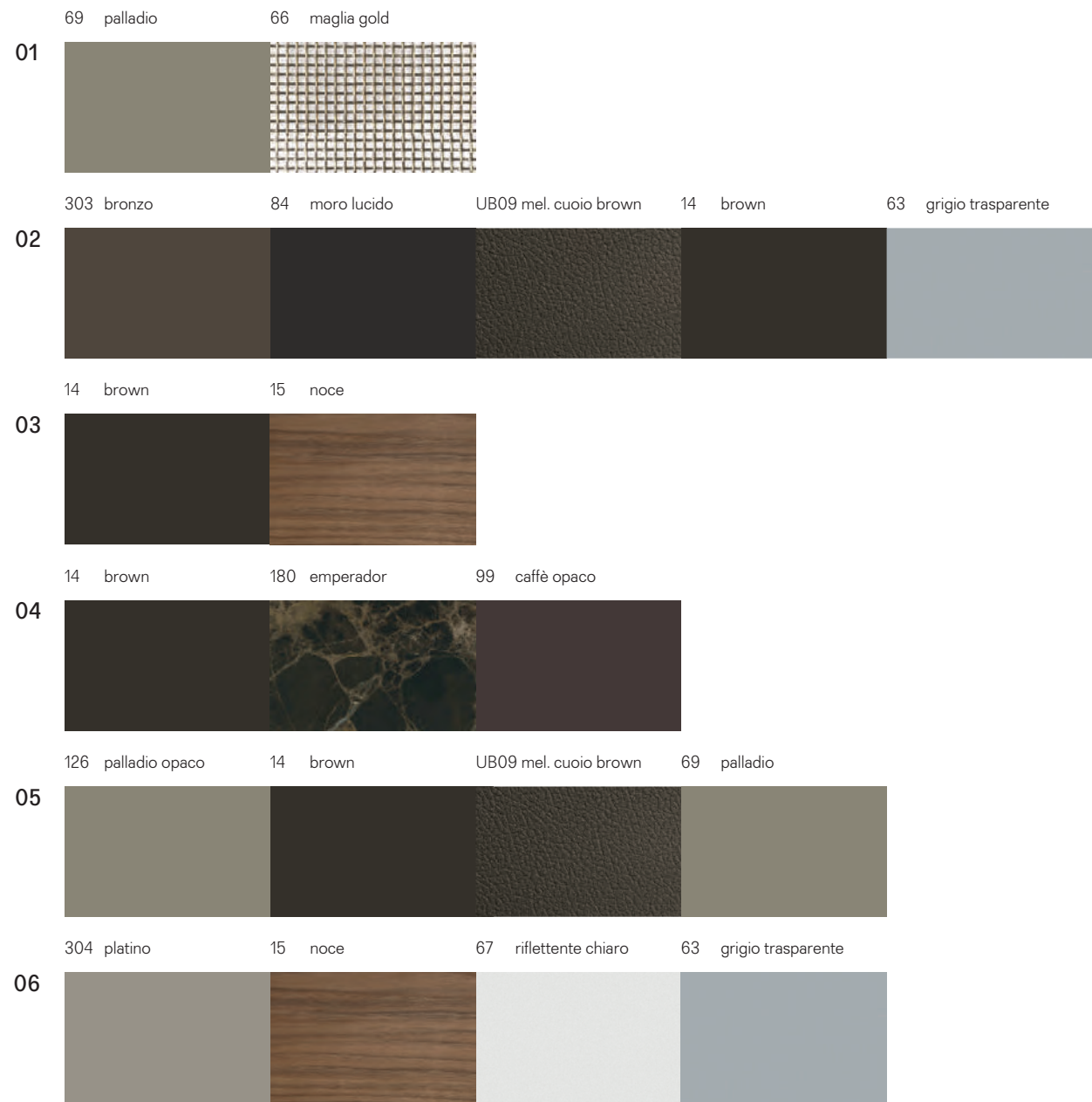

Pianta
Plan

Prodotti
Products

- 01 Velaria
- 02 Self up
- 03 Manta
- 04 Tray
- 05 Self Eos
- 06 Alambra

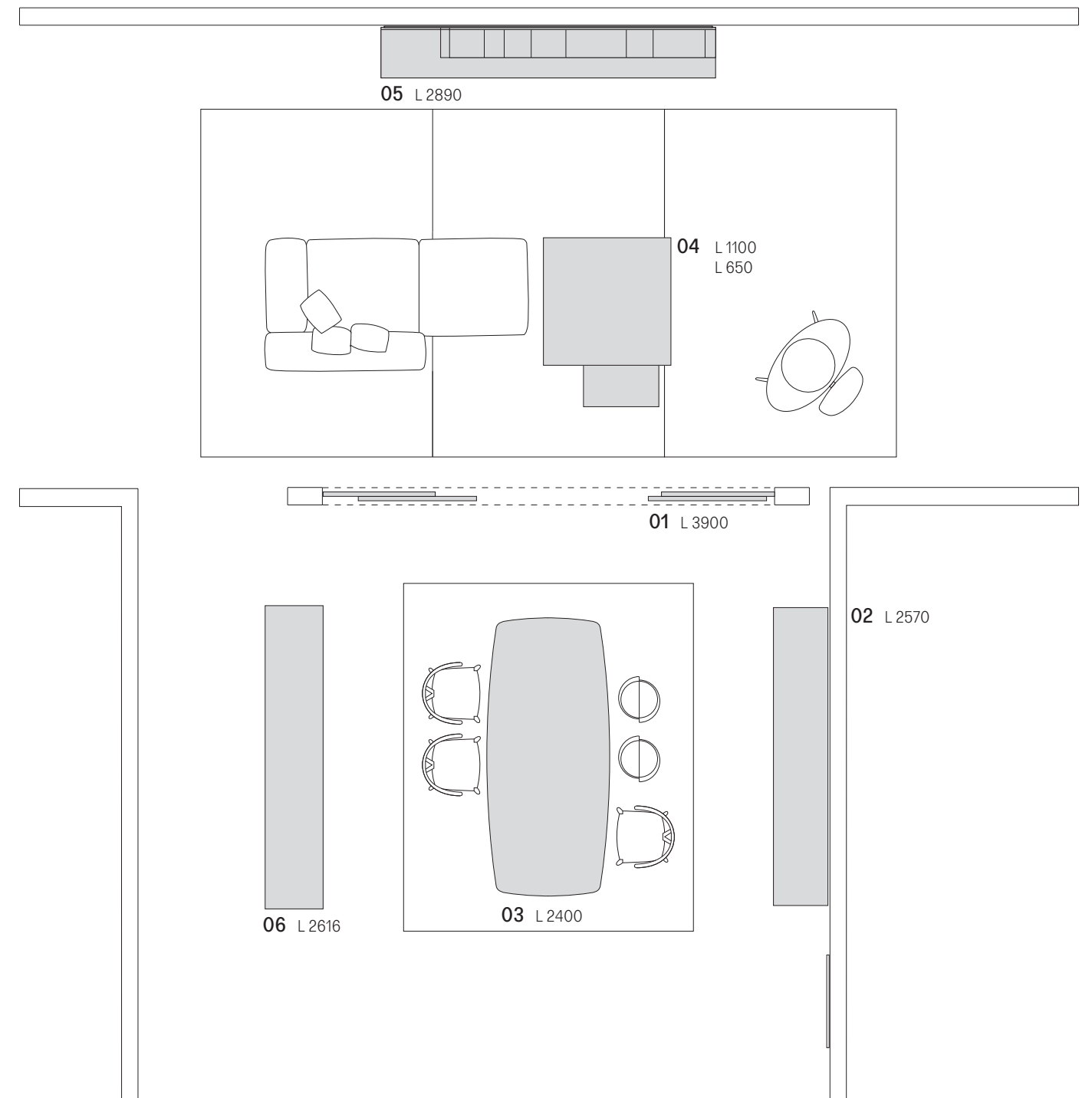



Rimadesio

Finiture
Finishings

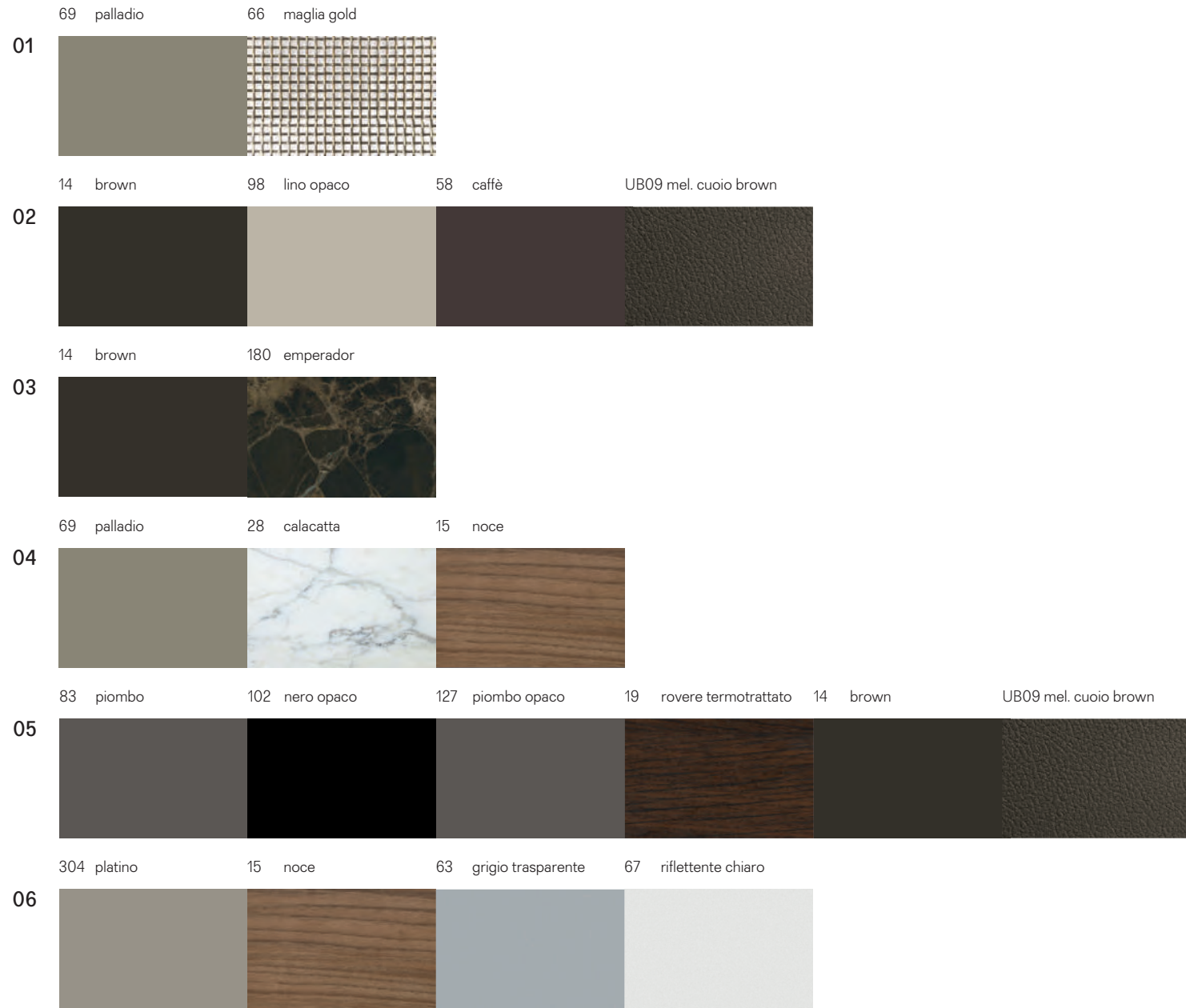

Pianta
Plan

Prodotti
Products

- 01 Velaria
- 02 Self up
- 03 Manta
- 04 Tray
- 05 Abacus living
- 06 Alambra

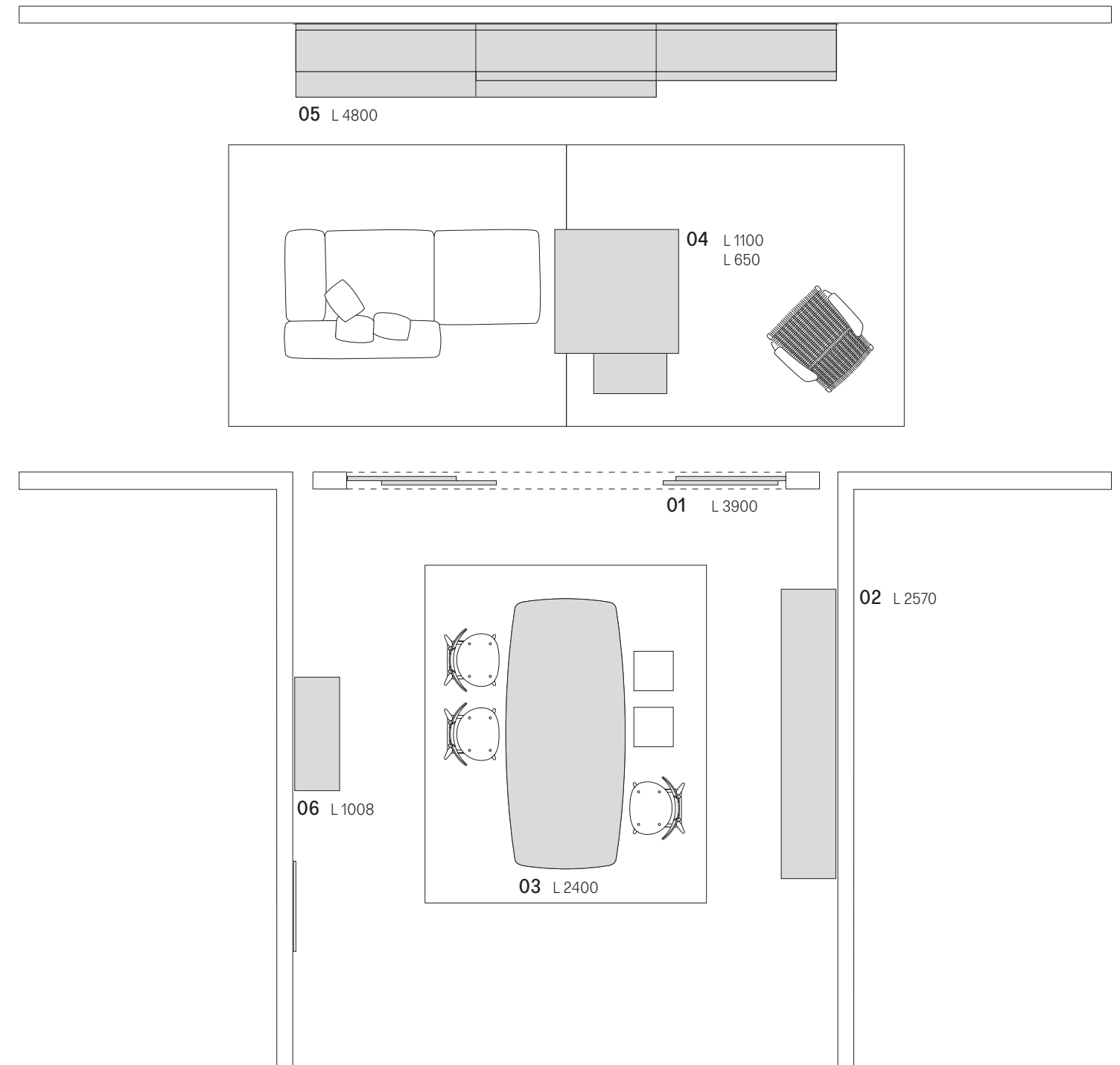



Finiture
Finishings

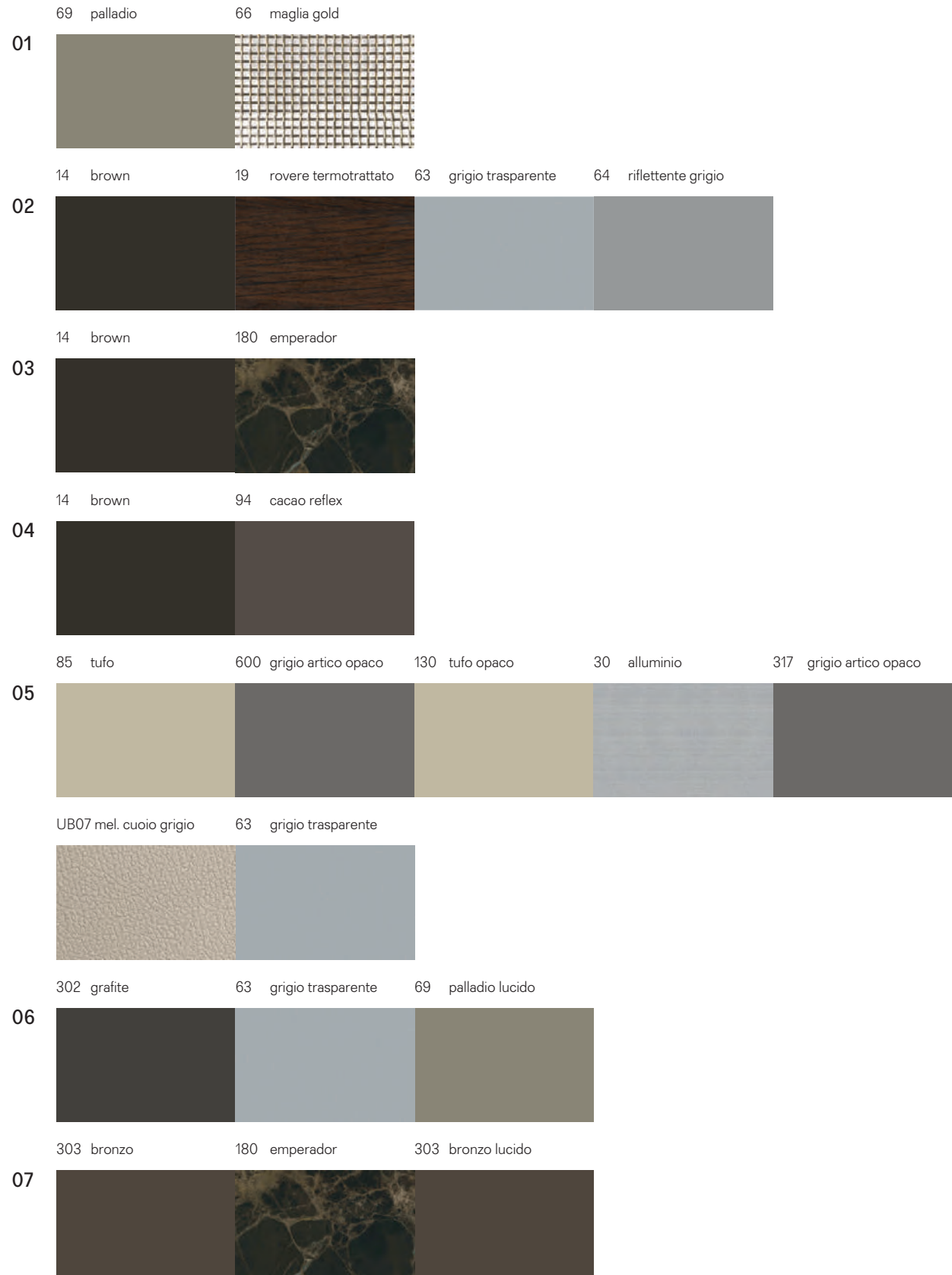

Pianta
Plan

Prodotti
Products

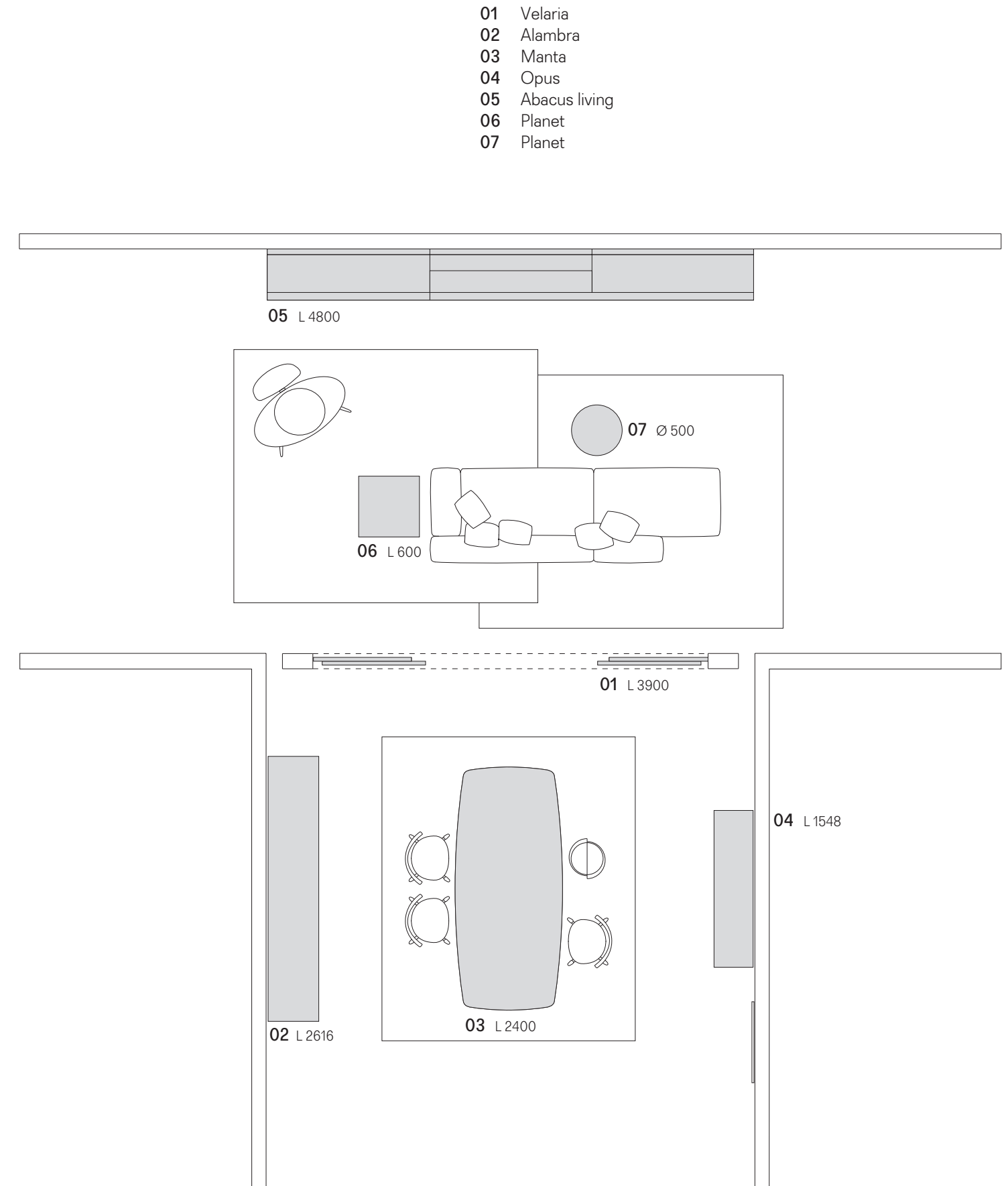



Finiture
Finishings

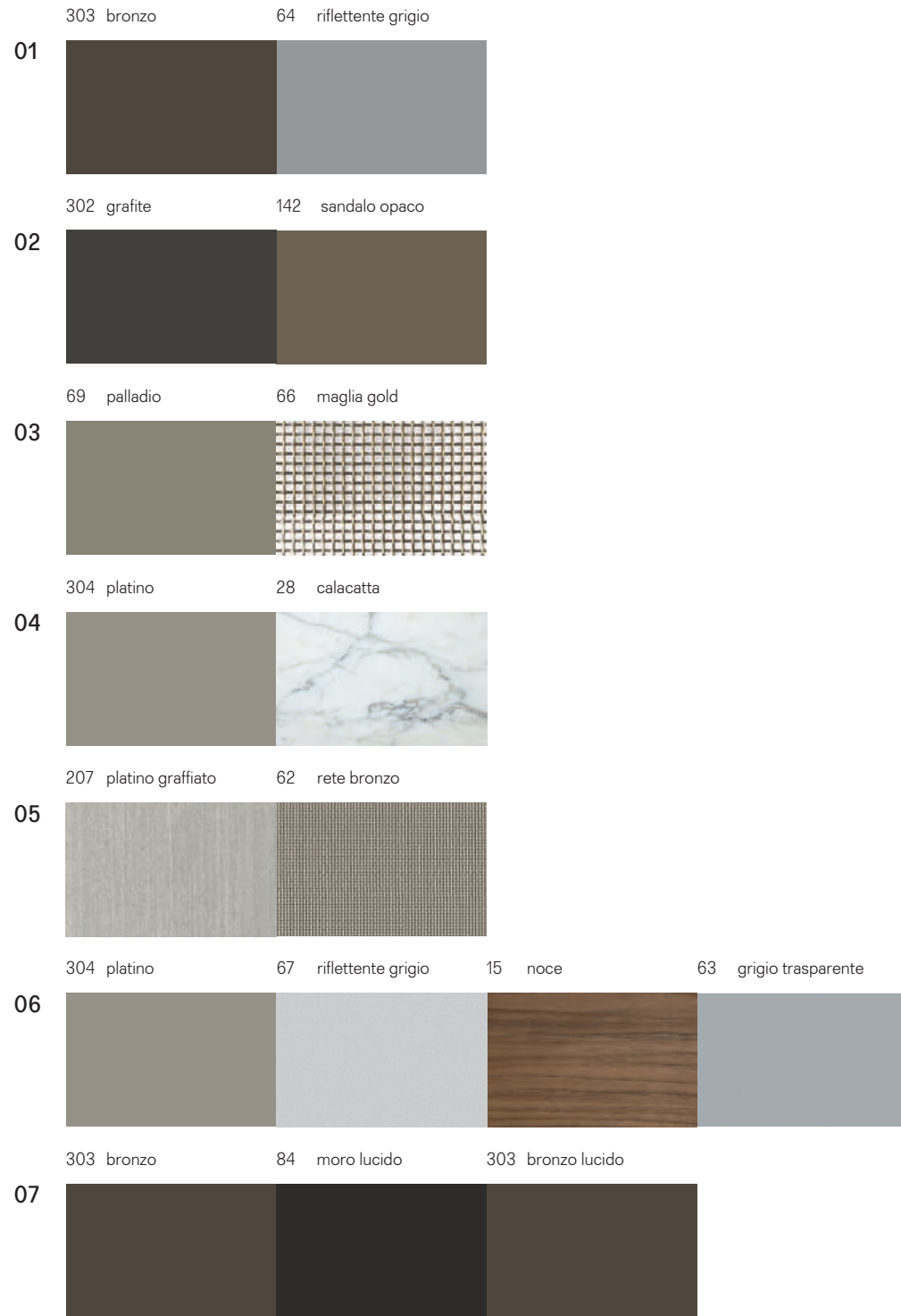

Pianta
Plan

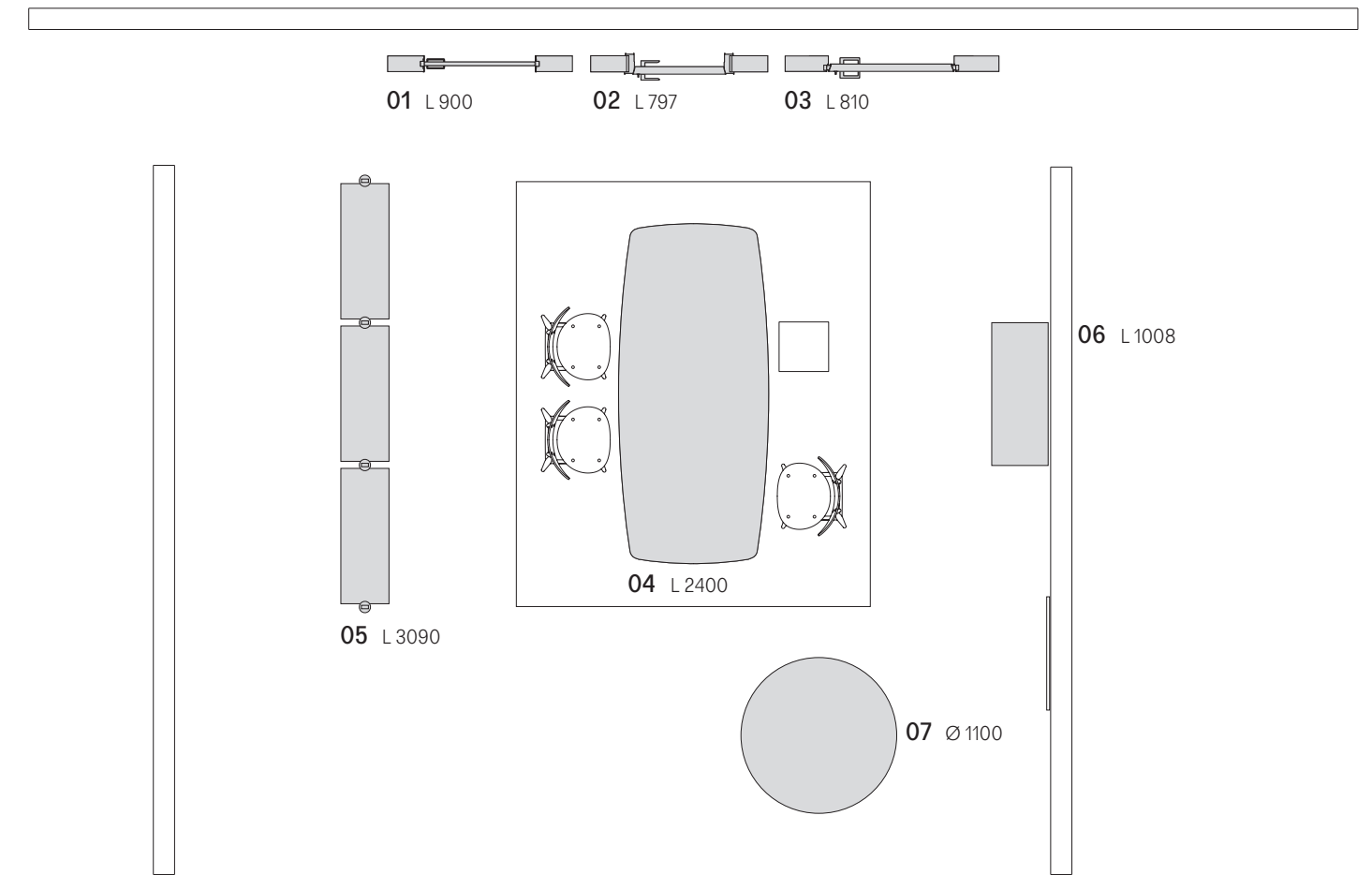

Prodotti
Products

- 01 Vela
- 02 Luxor
- 03 Zen
- 04 Manta
- 05 Zenit
- 06 Alambra
- 07 Planet



Finiture
Finishings

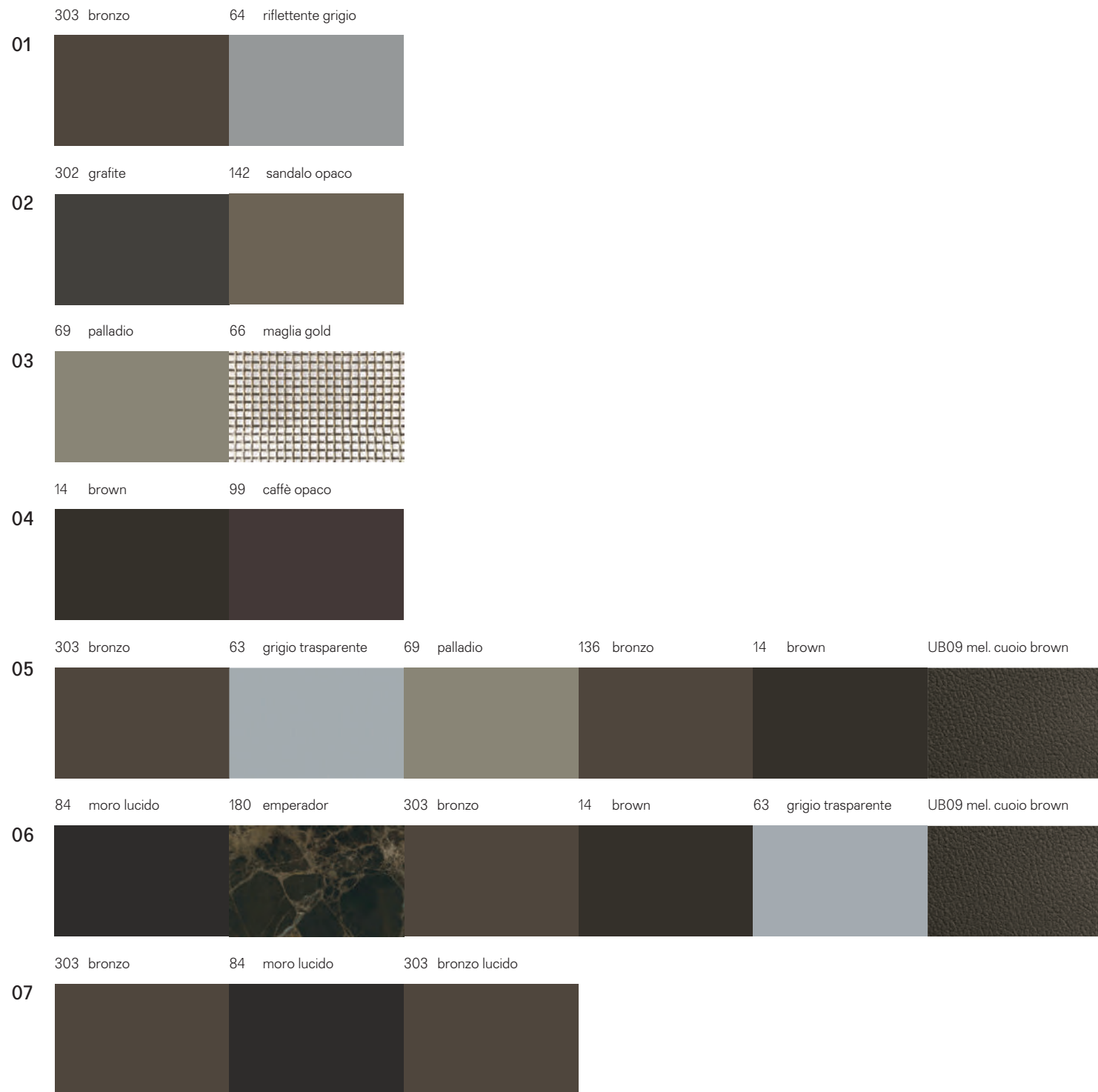

Pianta
Plan

Prodotti
Products

- 01 Vela
- 02 Luxor
- 03 Zen
- 04 Flat
- 05 Wind freestanding
- 06 Self bold
- 07 Planet

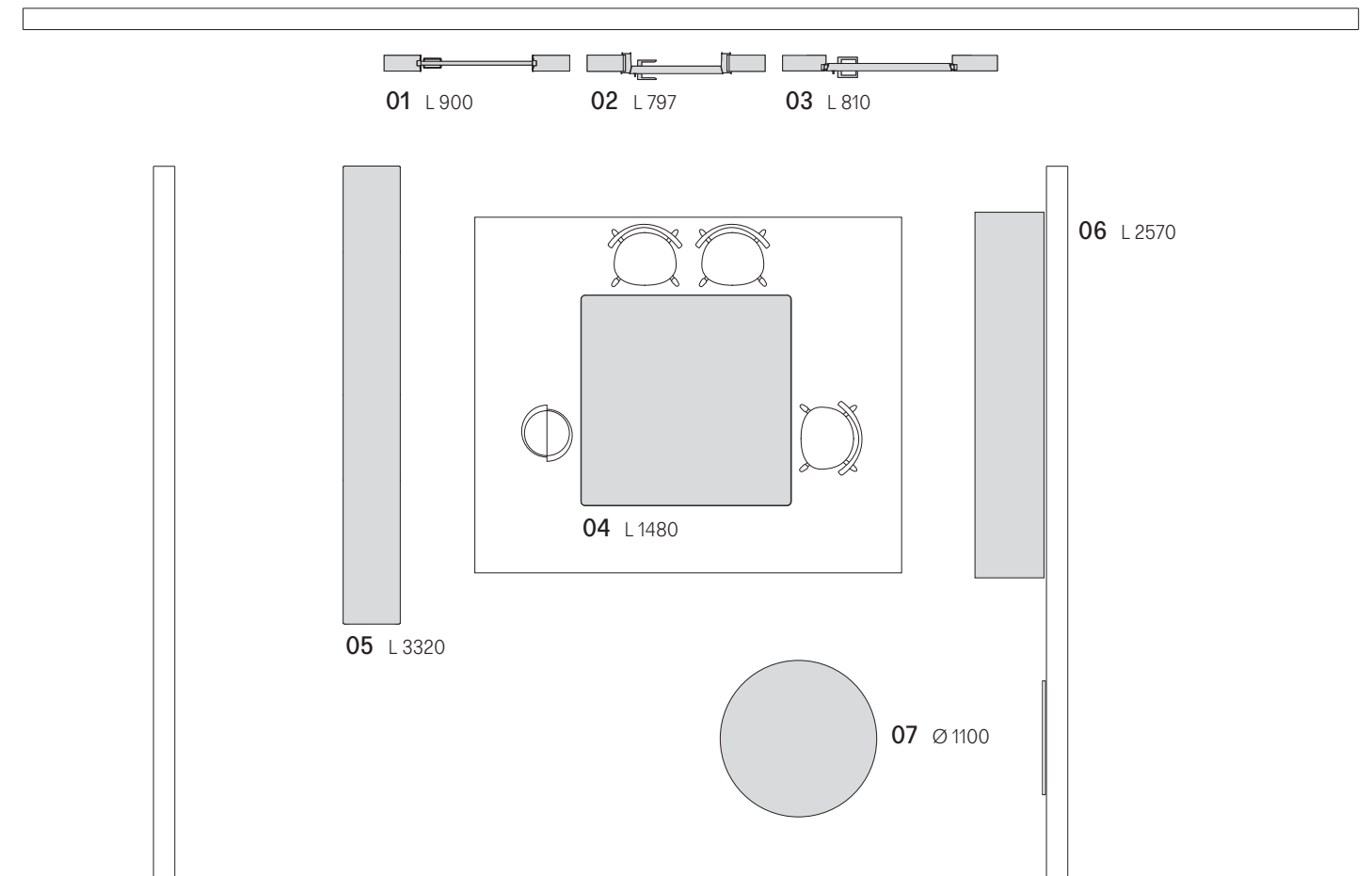



Rimadesio

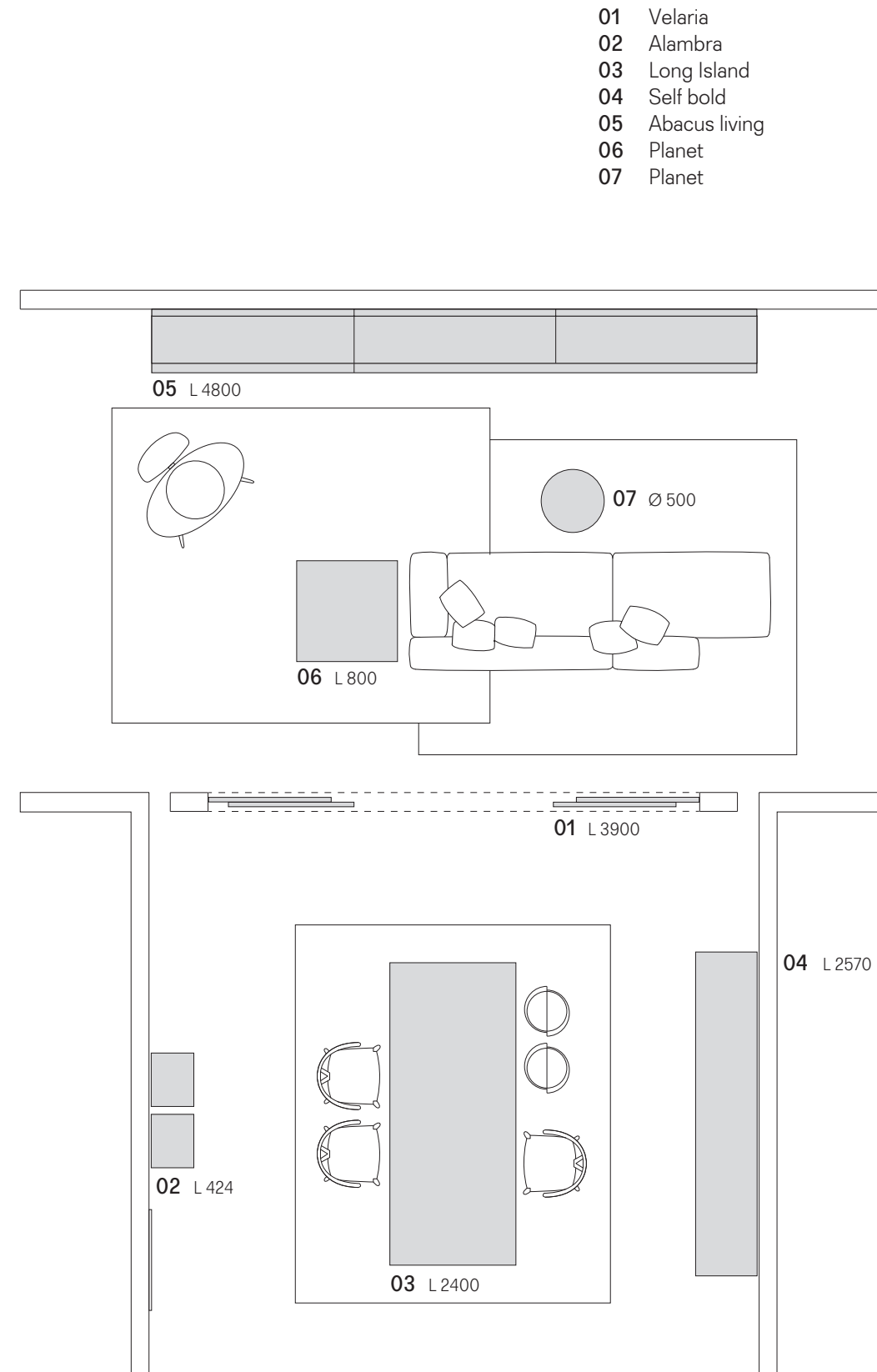
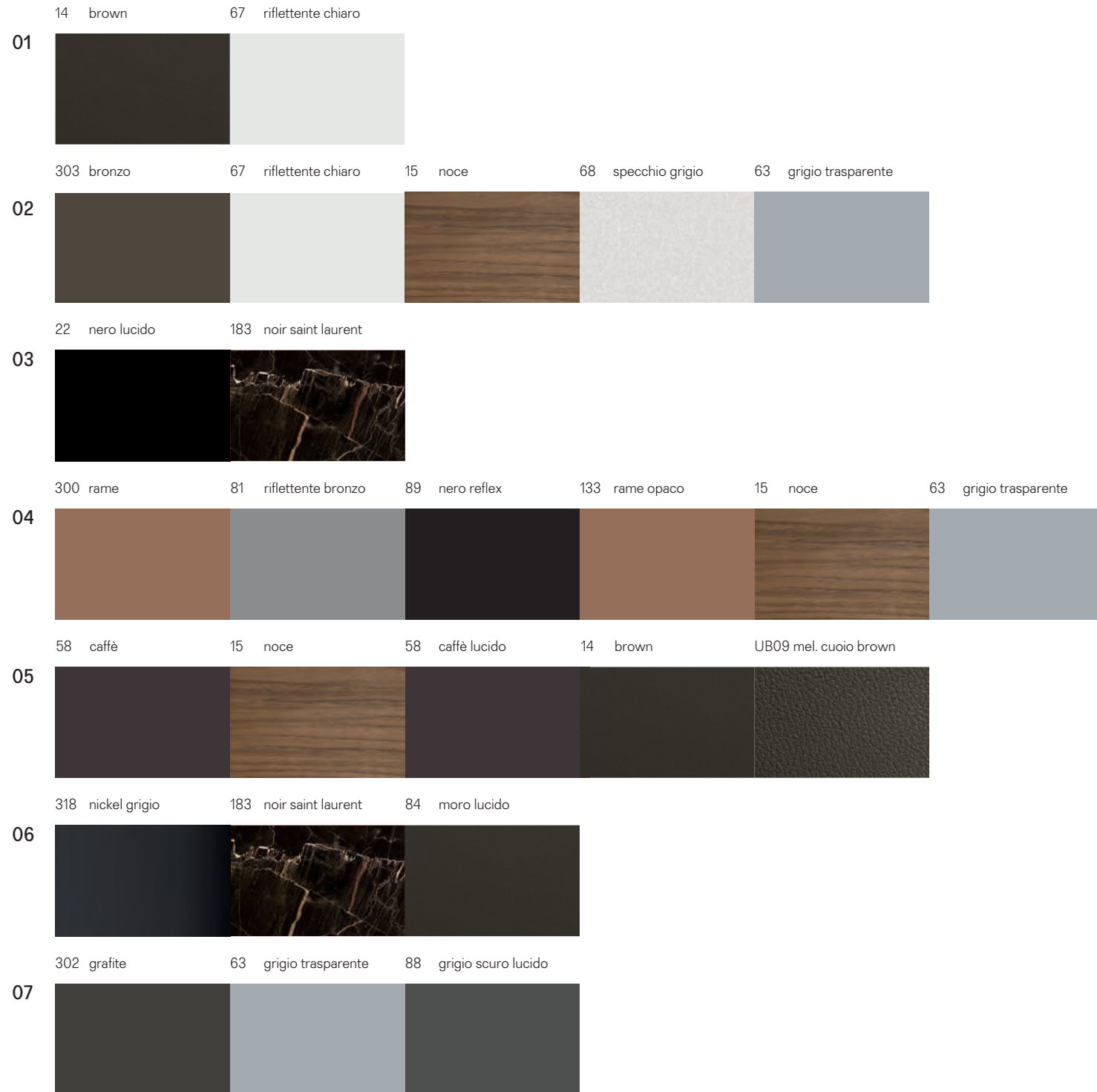



Rimadesio

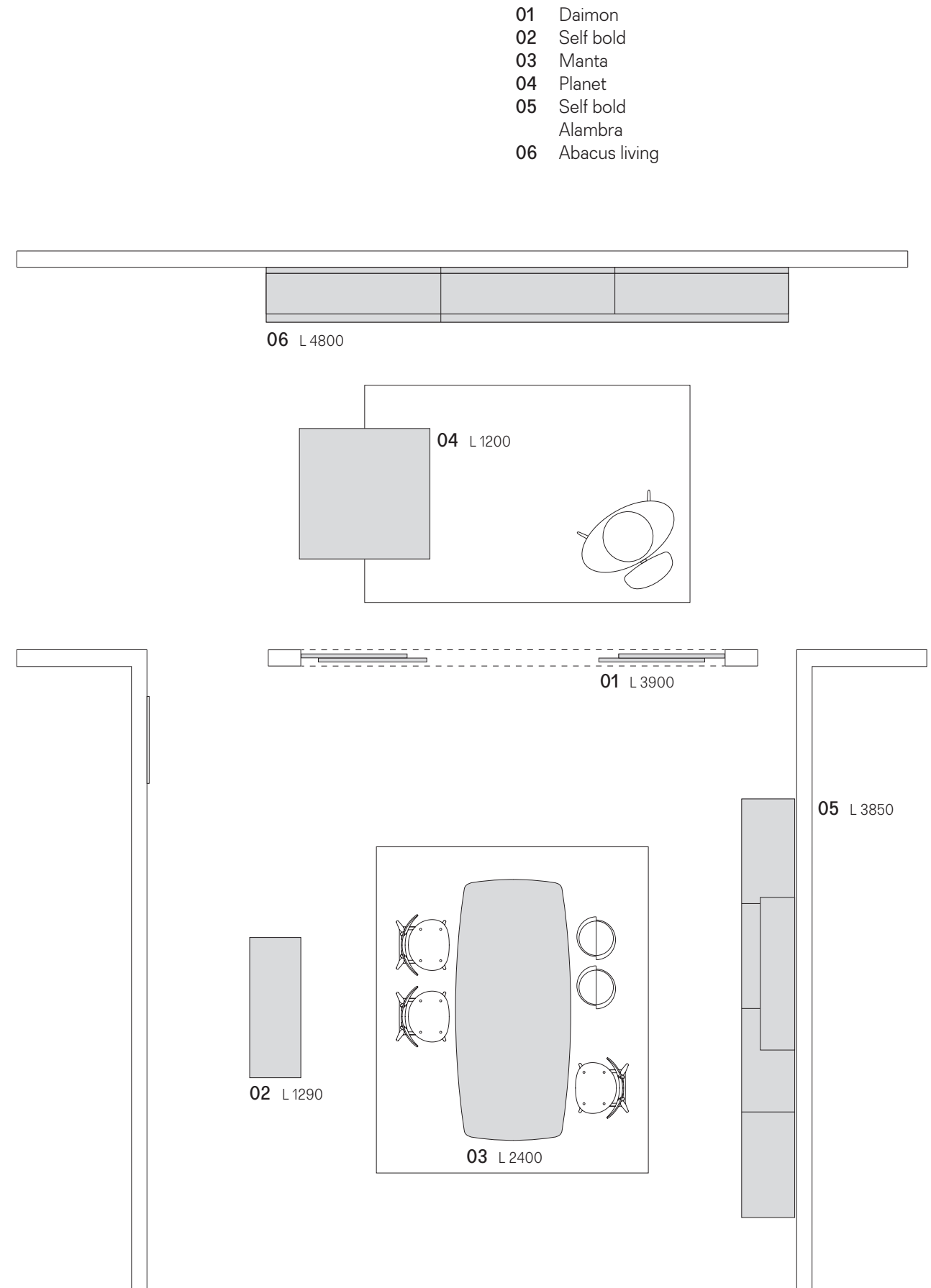
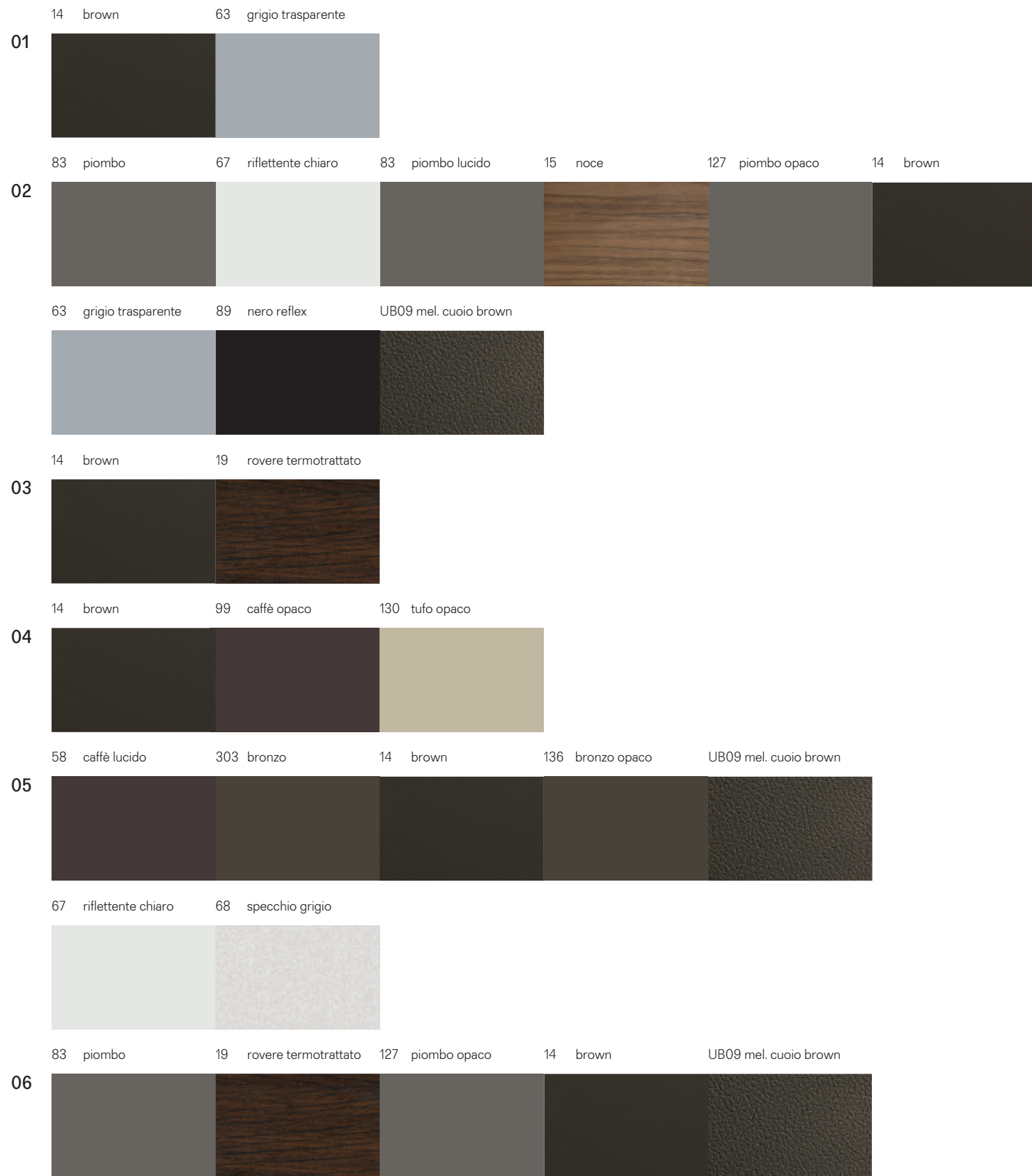



Finiture
Finishings

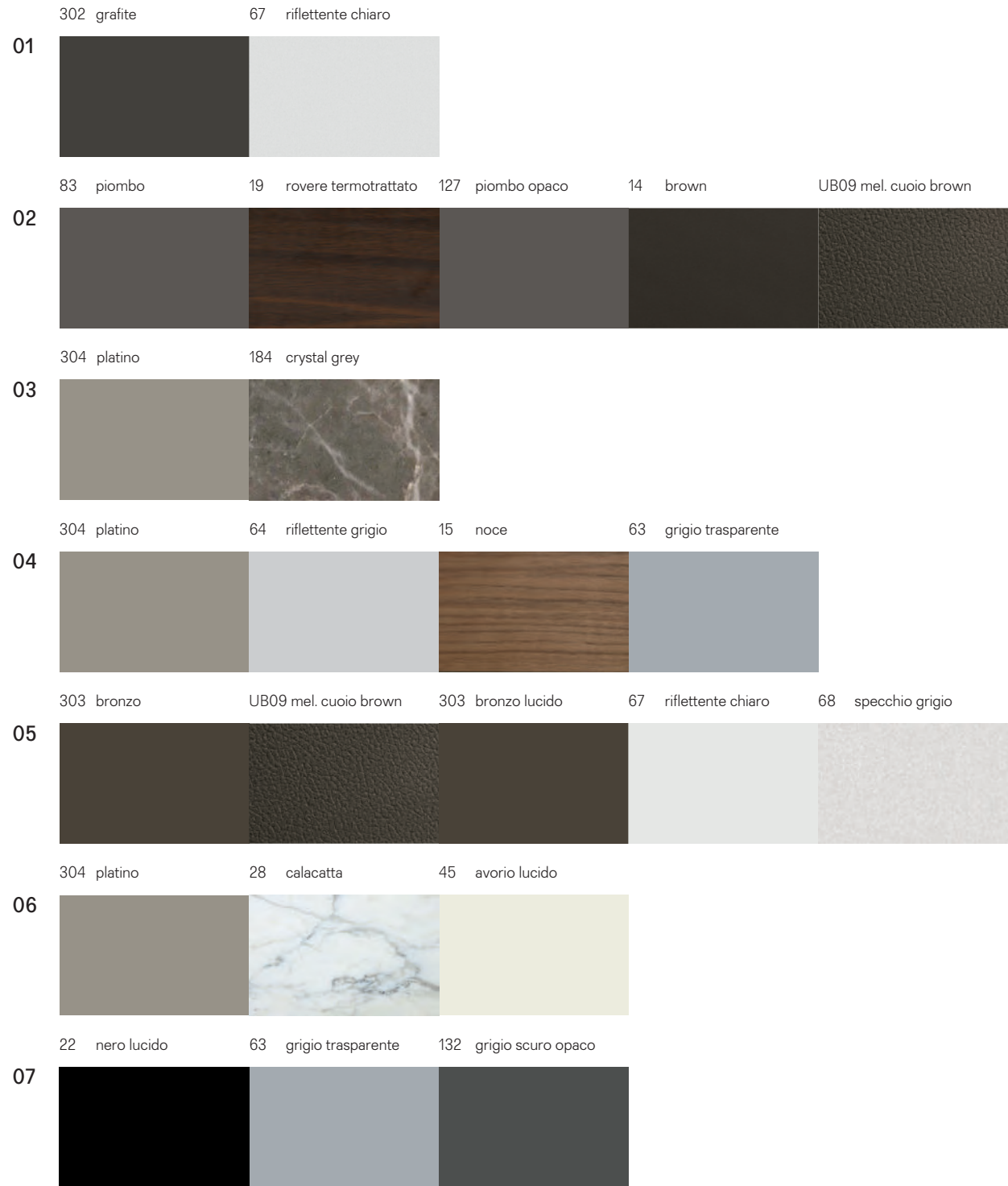

Pianta
Plan

Prodotti
Products

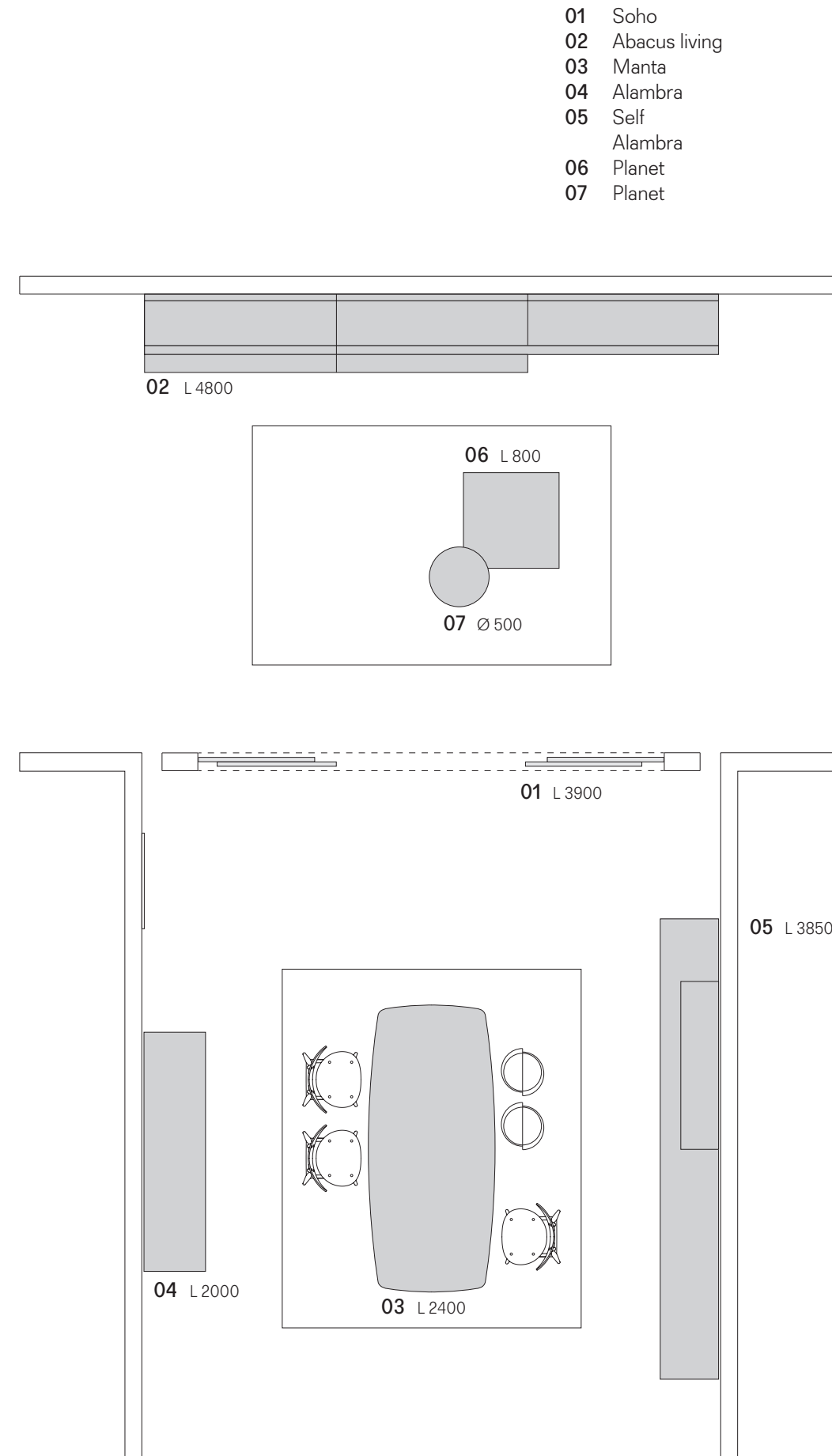

- 01 Soho
- 02 Abacus living
- 03 Manta
- 04 Alambra
- 05 Self Alambra
- 06 Planet
- 07 Planet

Living 06L1



Finiture
Finishings

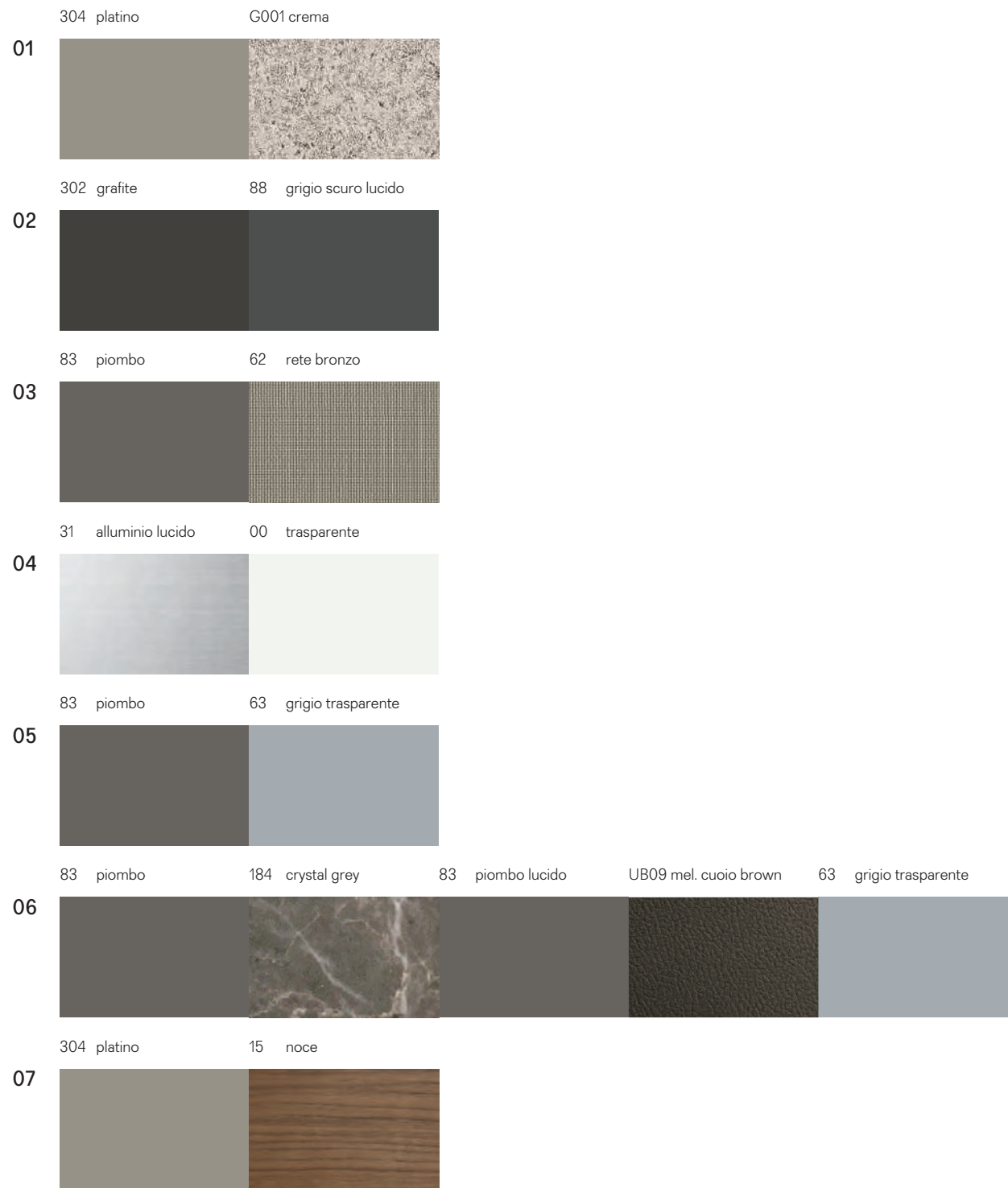

Pianta
Plan

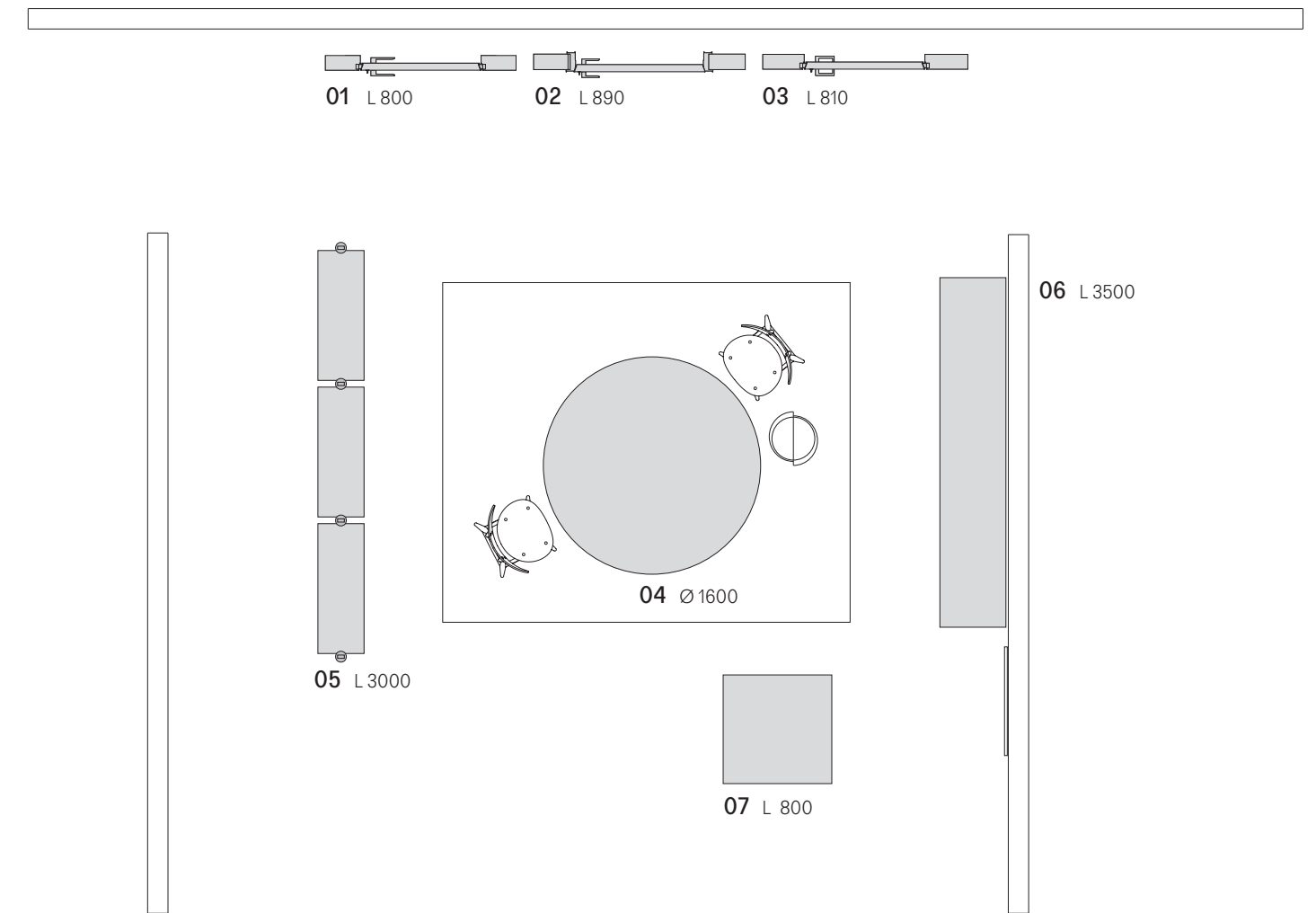

Prodotti
Products

- 01 Moon
- 02 Luxor
- 03 Zen
- 04 Manta
- 05 Zenit
- 06 Self bold
- 07 Tray



Finiture
Finishings

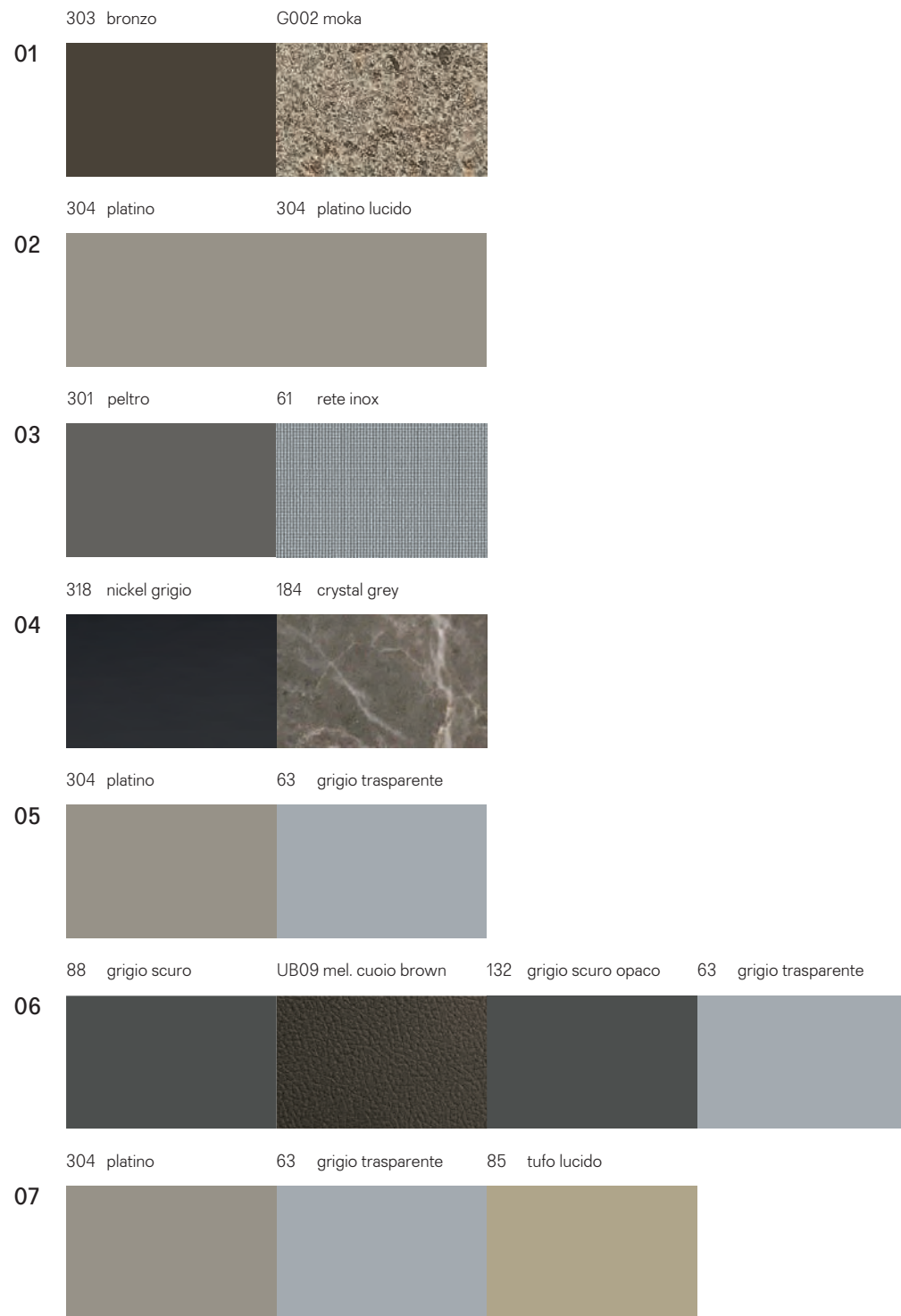

Pianta
Plan

Prodotti
Products

- 01 Moon
- 02 Luxor
- 03 Zen
- 04 Long Island
- 05 Zenit
- 06 Self up
- 07 Planet

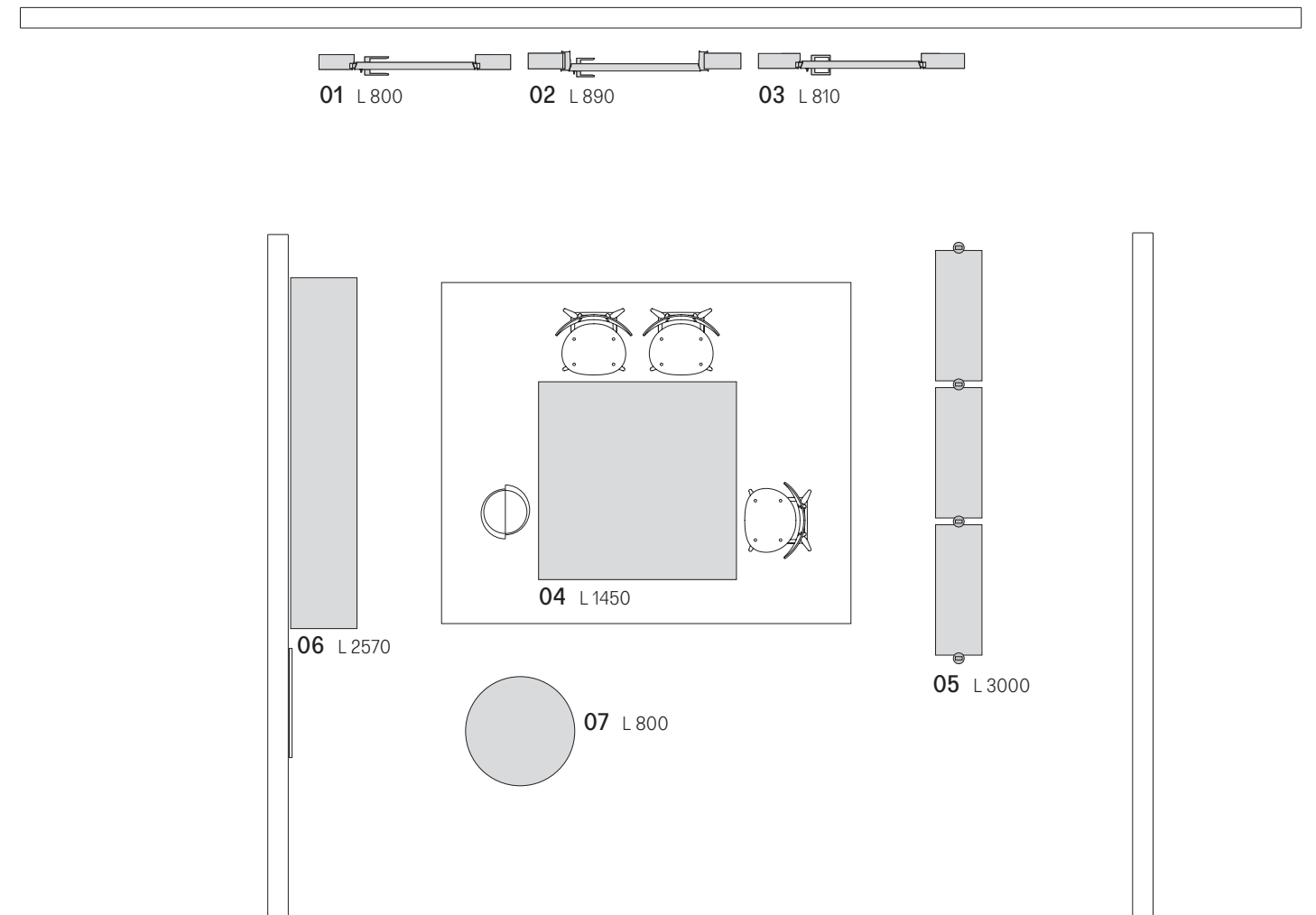



Rimadesio

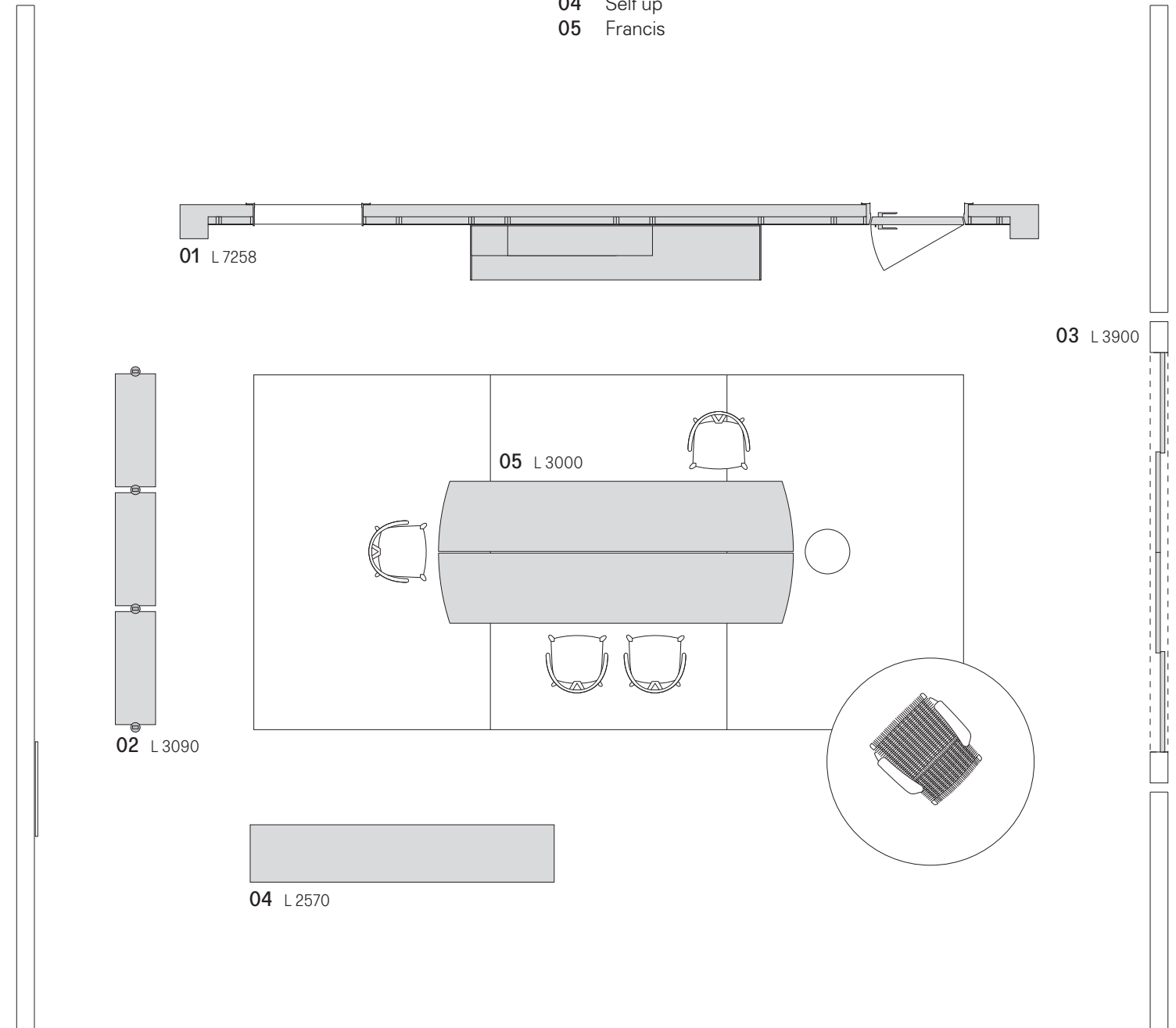
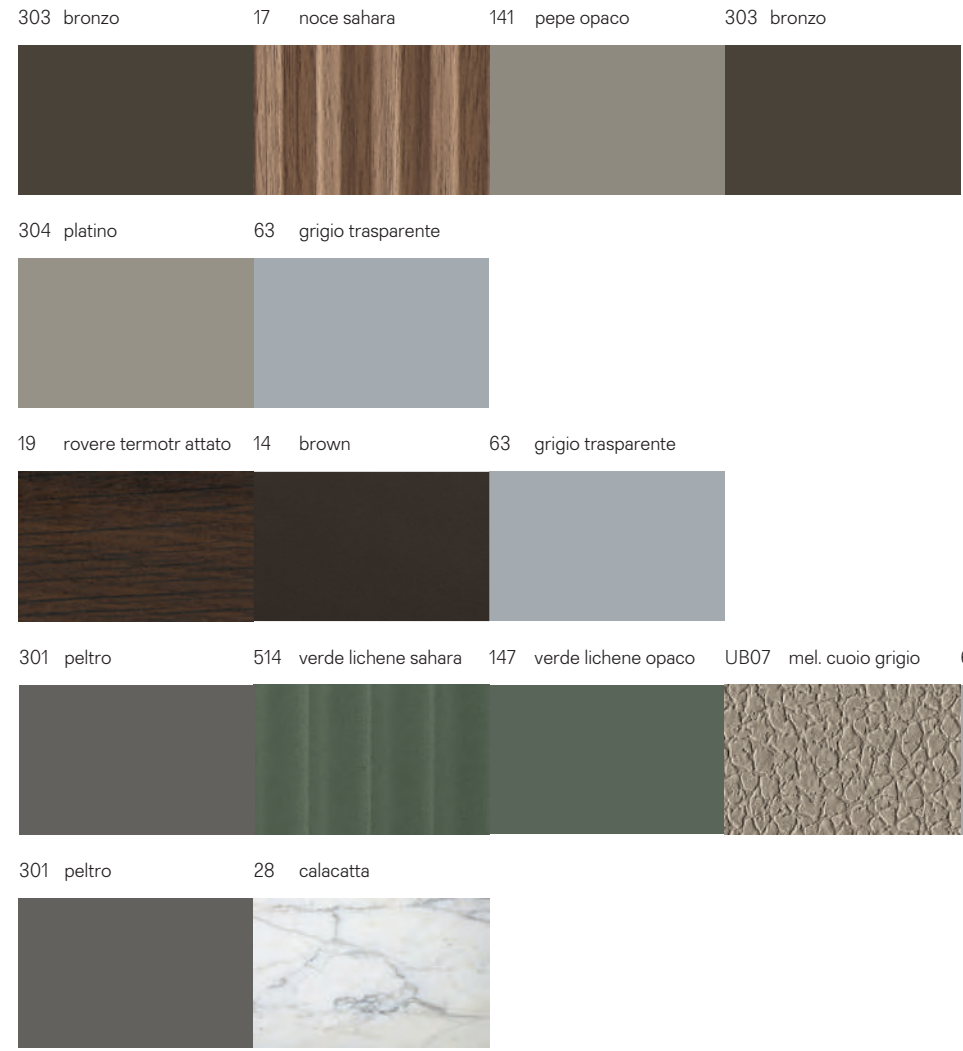

- 01 Modulor, Self bold
- 02 Zenit
- 03 Stripe
- 04 Self up
- 05 Francis



Rimadesio

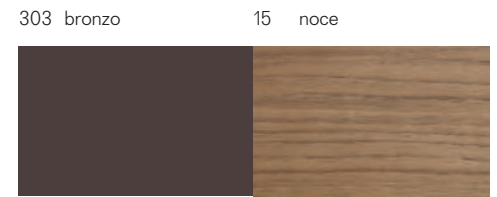
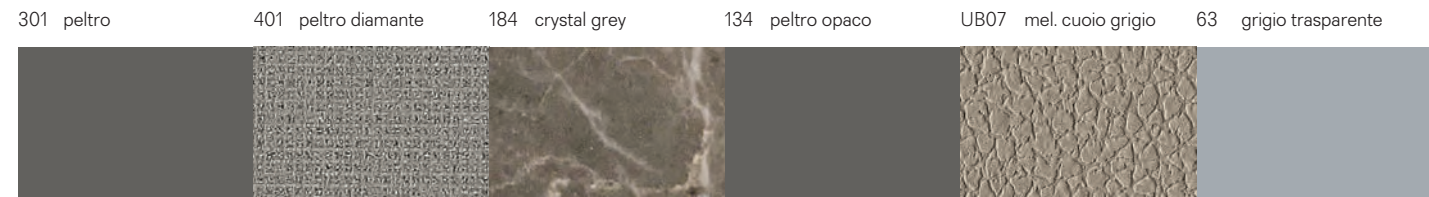
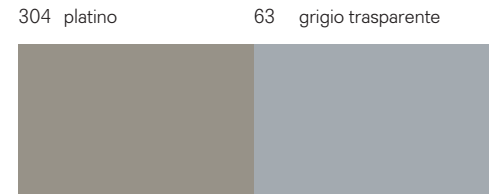

- 01 Modulor, Self bold
- 02 Zenit
- 03 Stripe
- 04 Self up
- 05 Francis

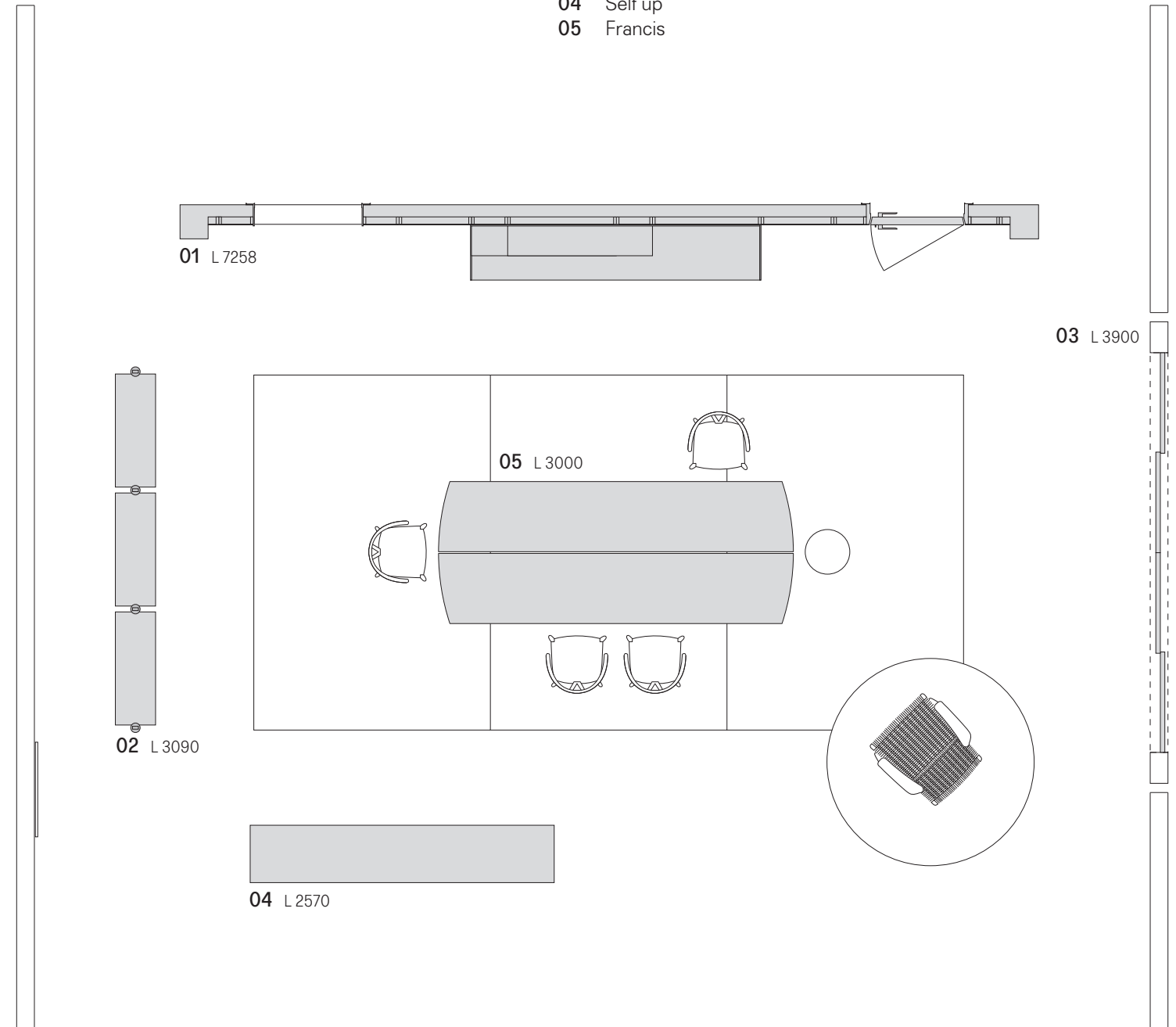



Rimadesio

Finiture
Finishings

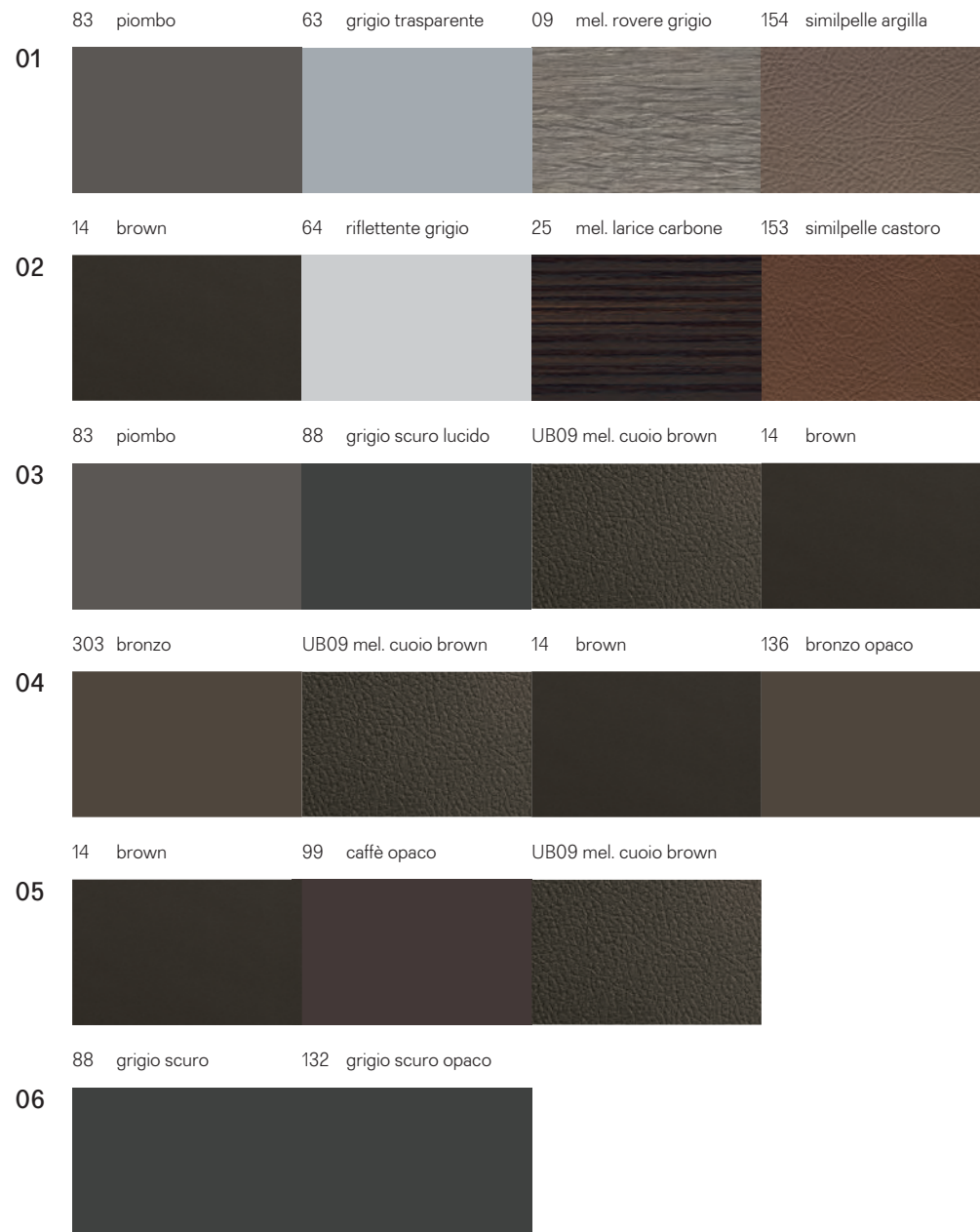

Pianta
Plan

Prodotti
Products

- 01 Zenit
- 02 Cover
- 03 Self up
- 04 Self up
- 05 Self up
- 06 Sixty coffee table

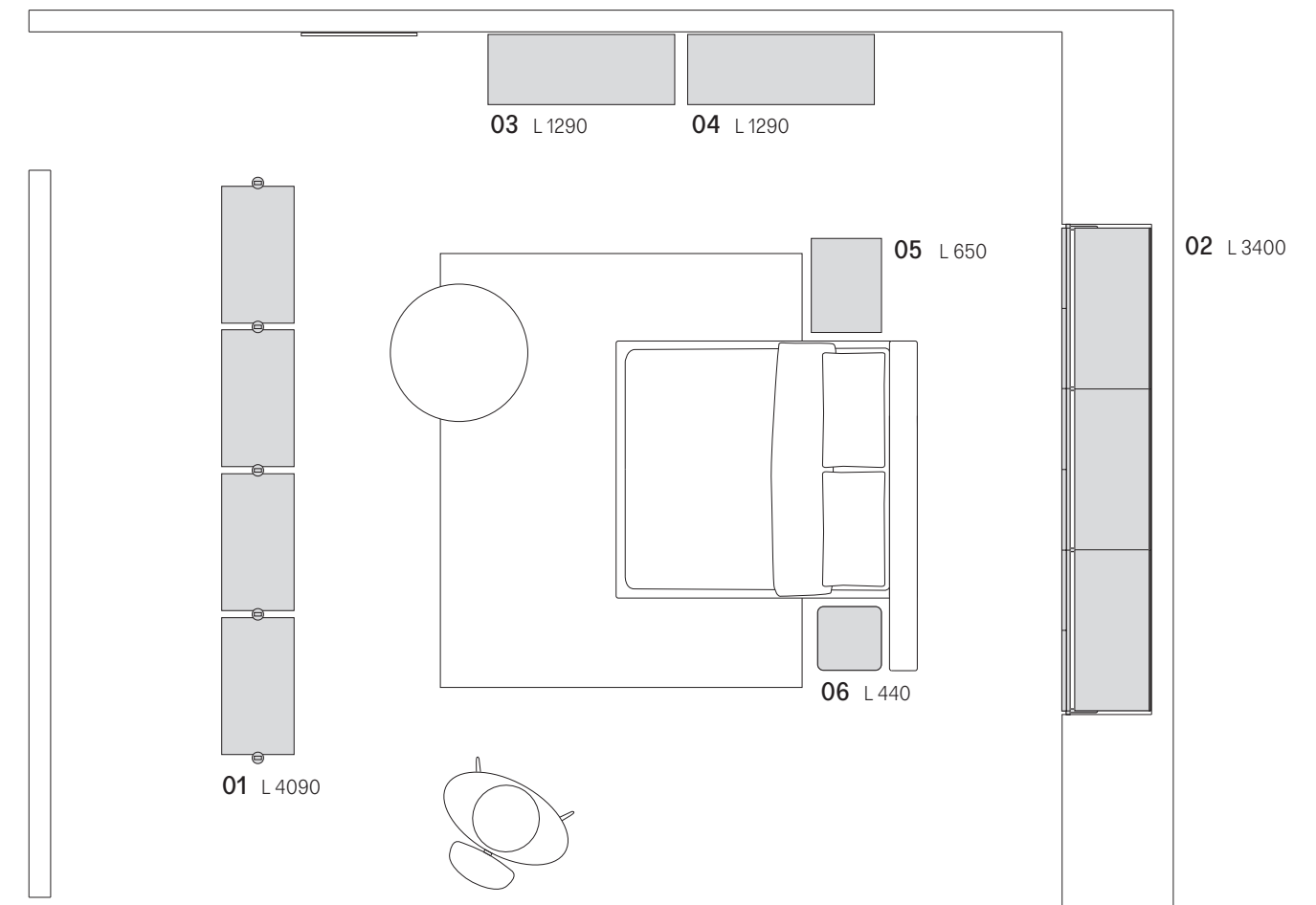



Finiture
Finishings

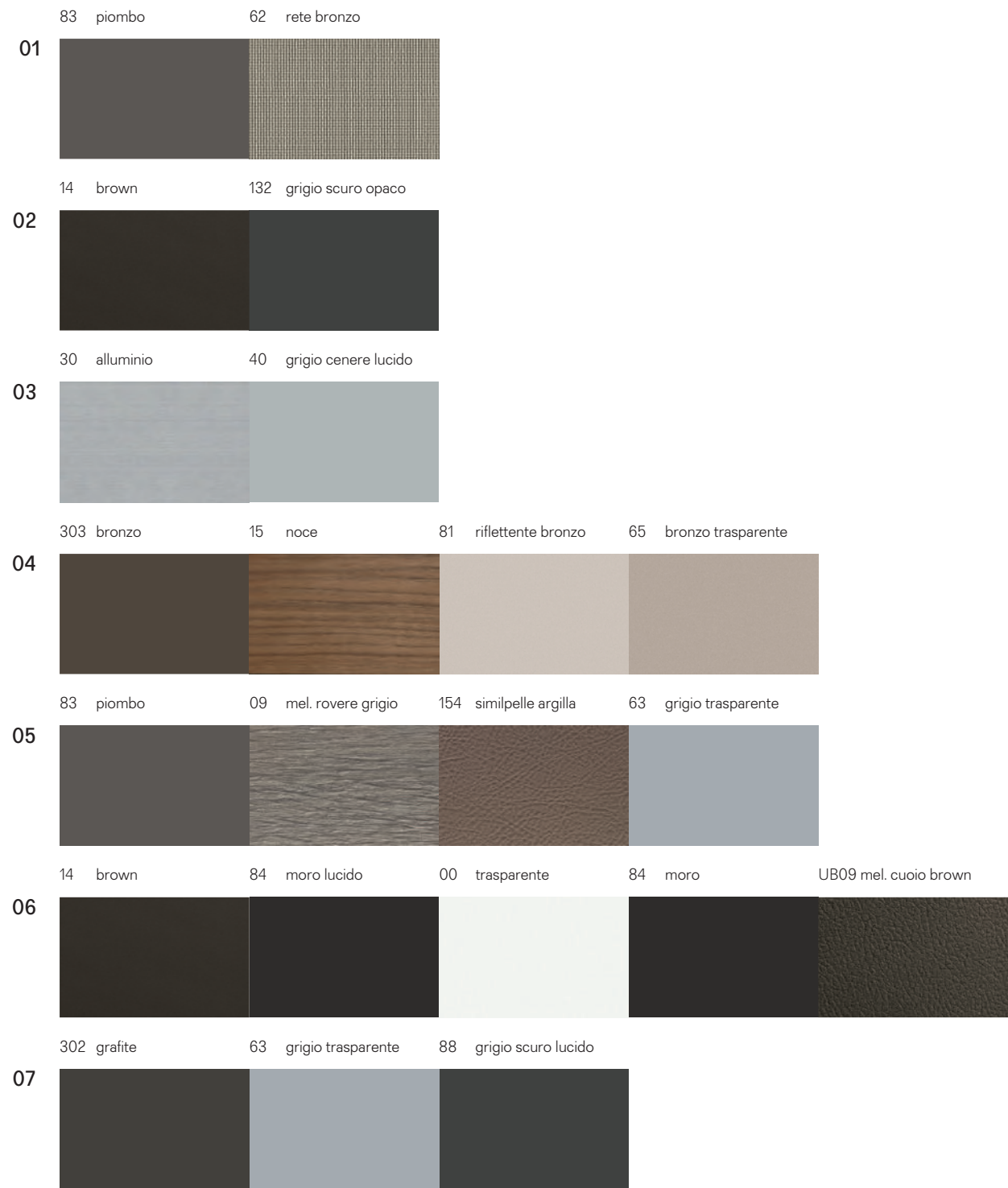

Pianta
Plan

Prodotti
Products

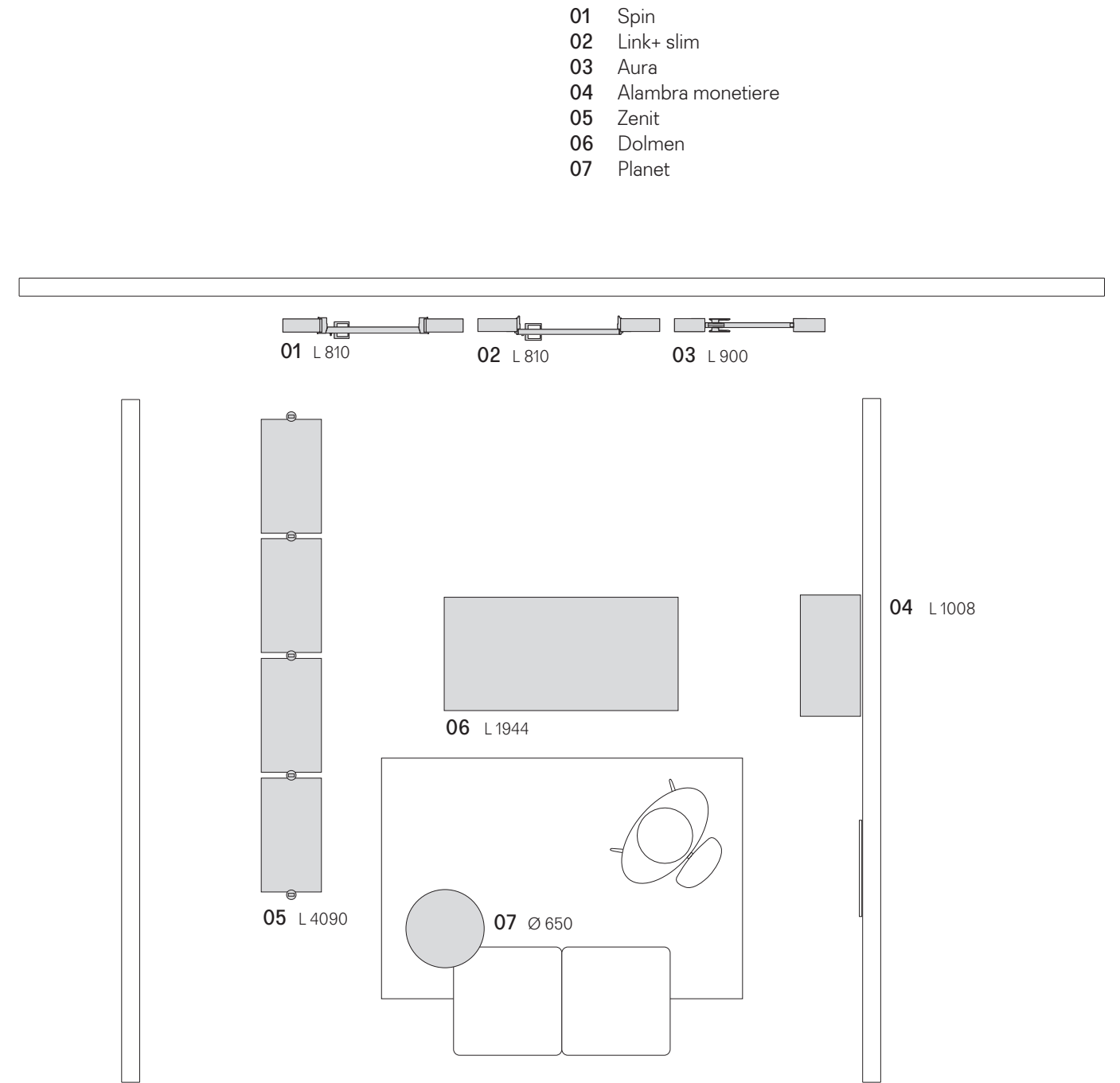



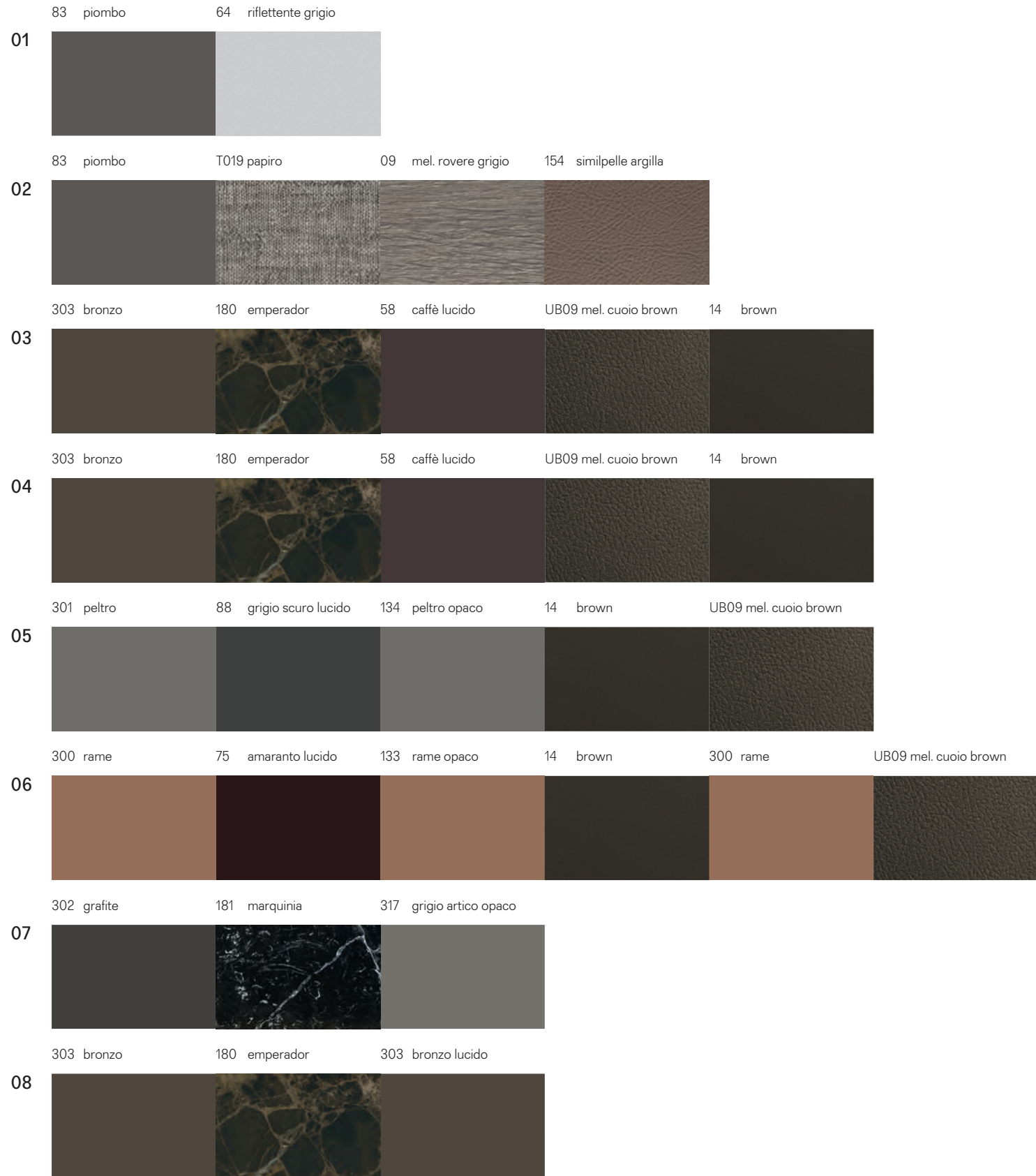

- 01 Graphis plus
- 02 Dress bold
- 03 Self bold
- 04 Self bold
- 05 Self bold
- 06 Self bold
- 07 Planet
- 08 Planet

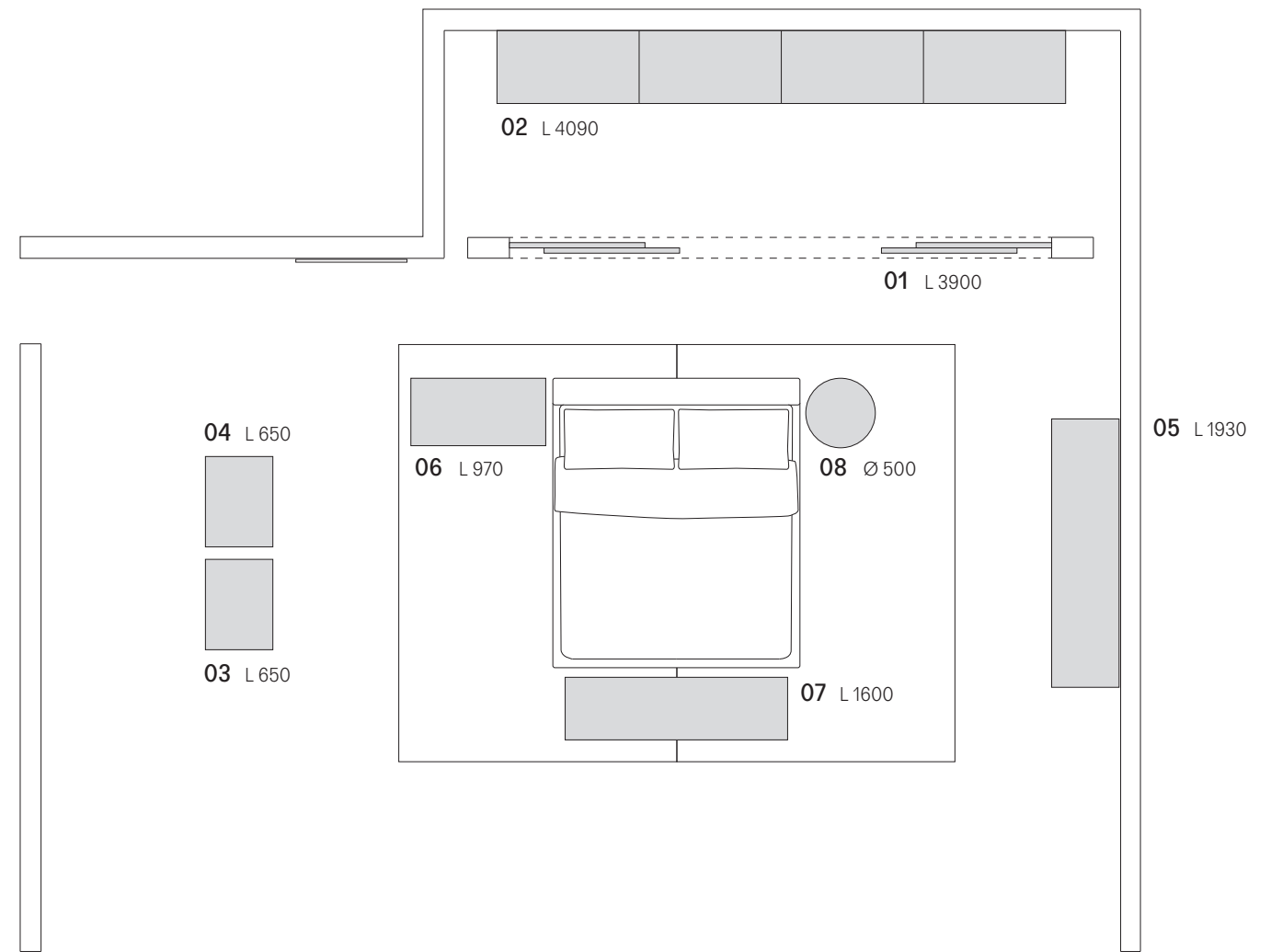



Rimadesio

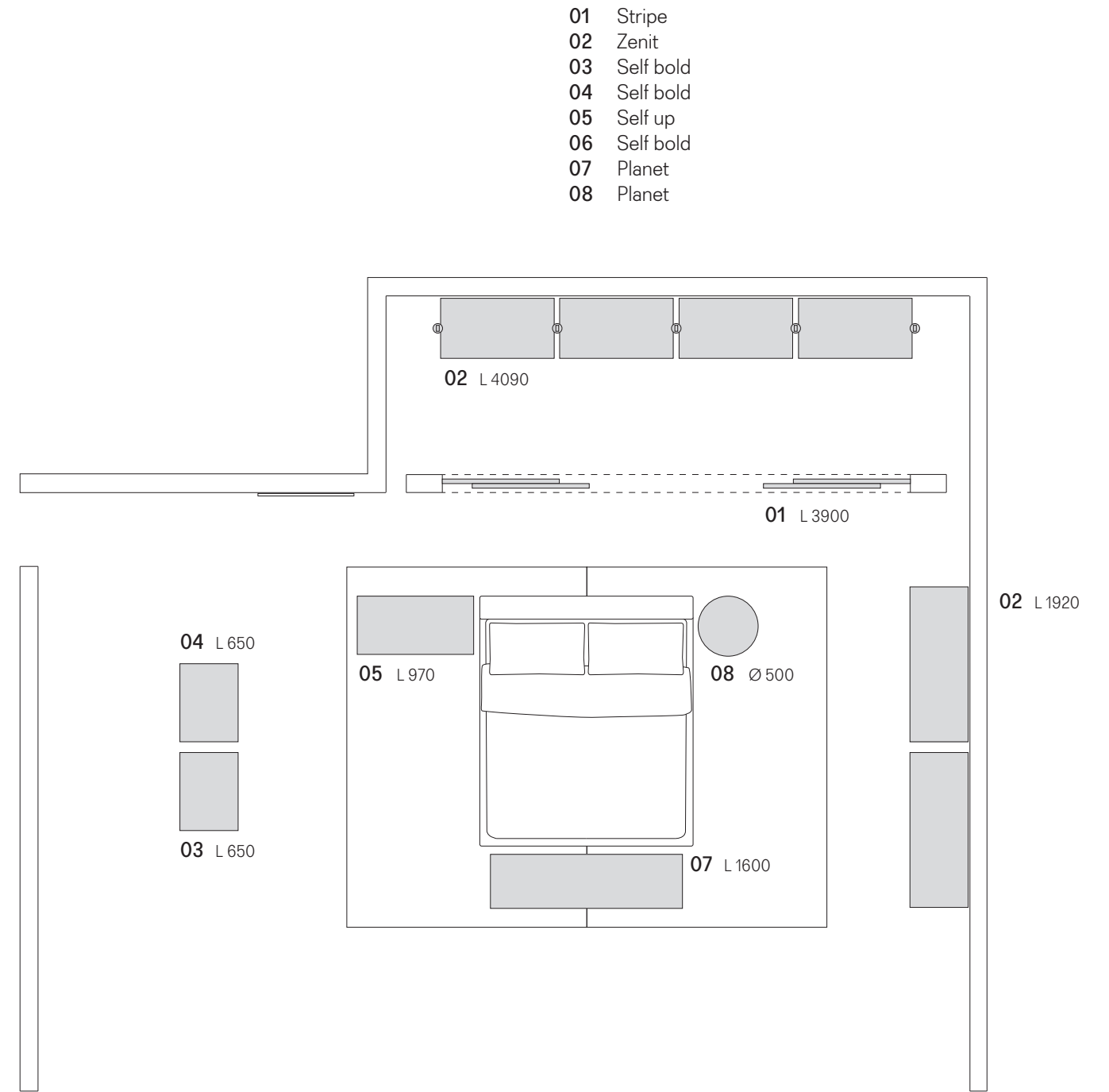
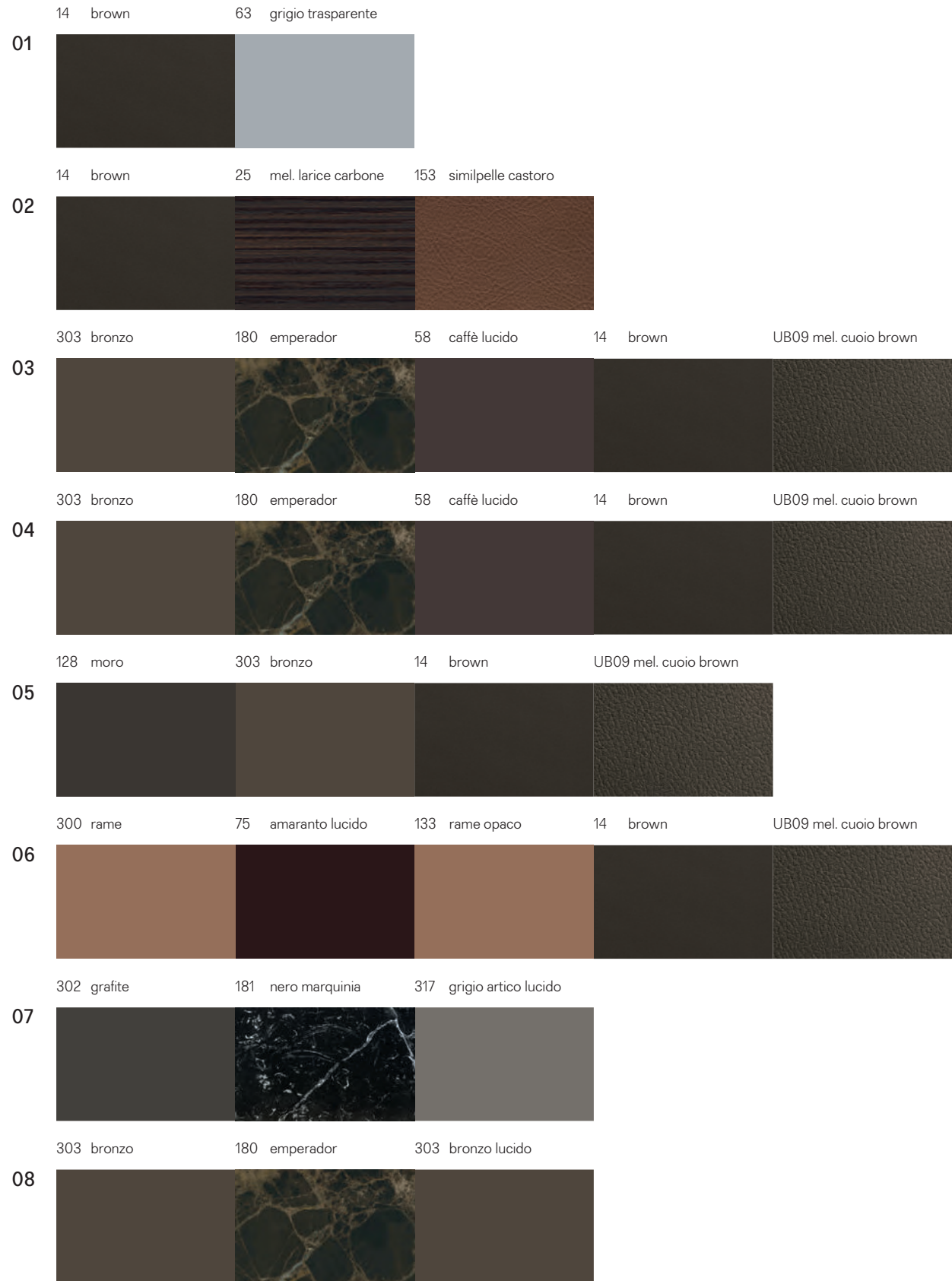



Rimadesio

Finiture
Finishings

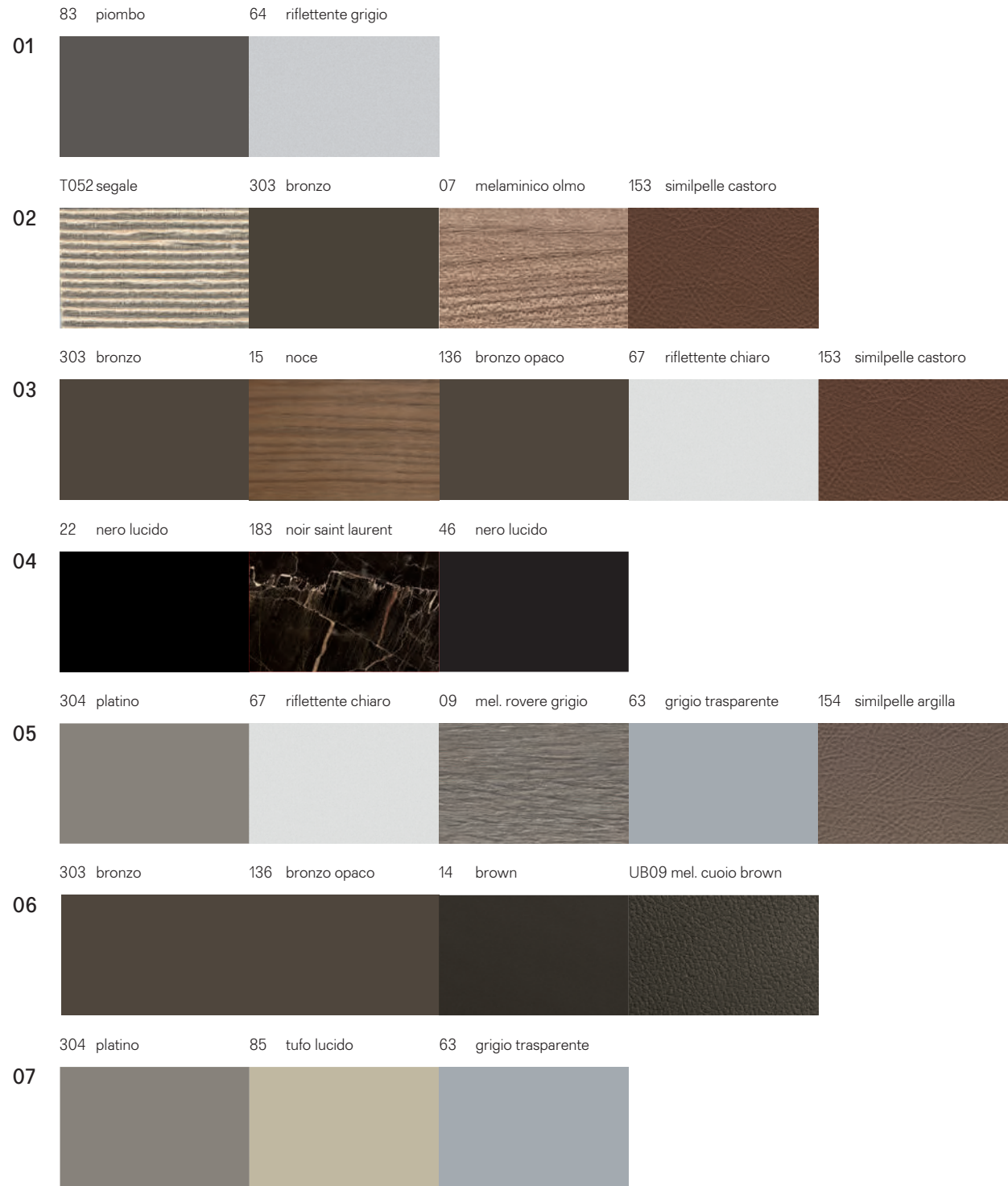

Pianta
Plan

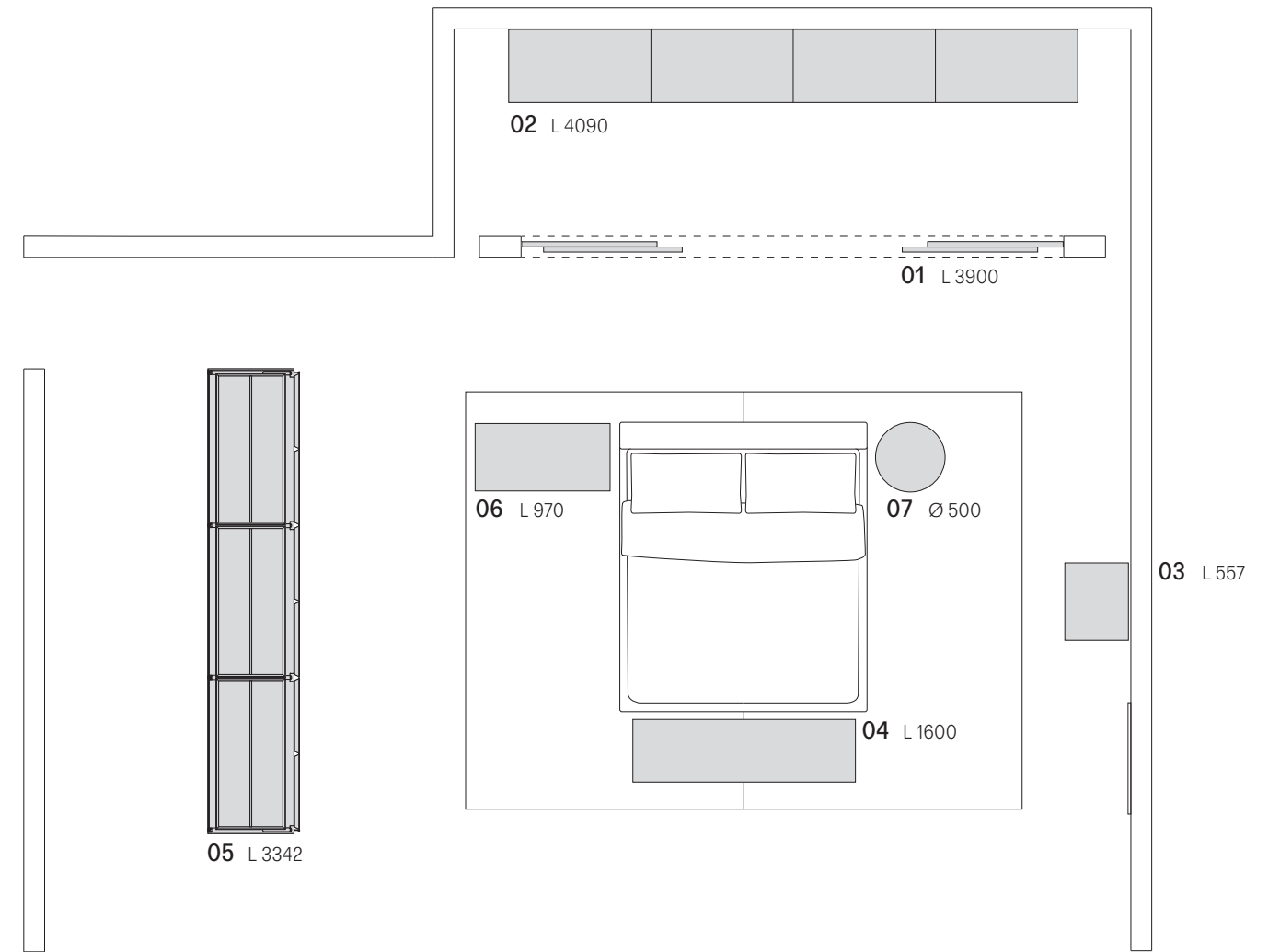



Finiture
Finishings

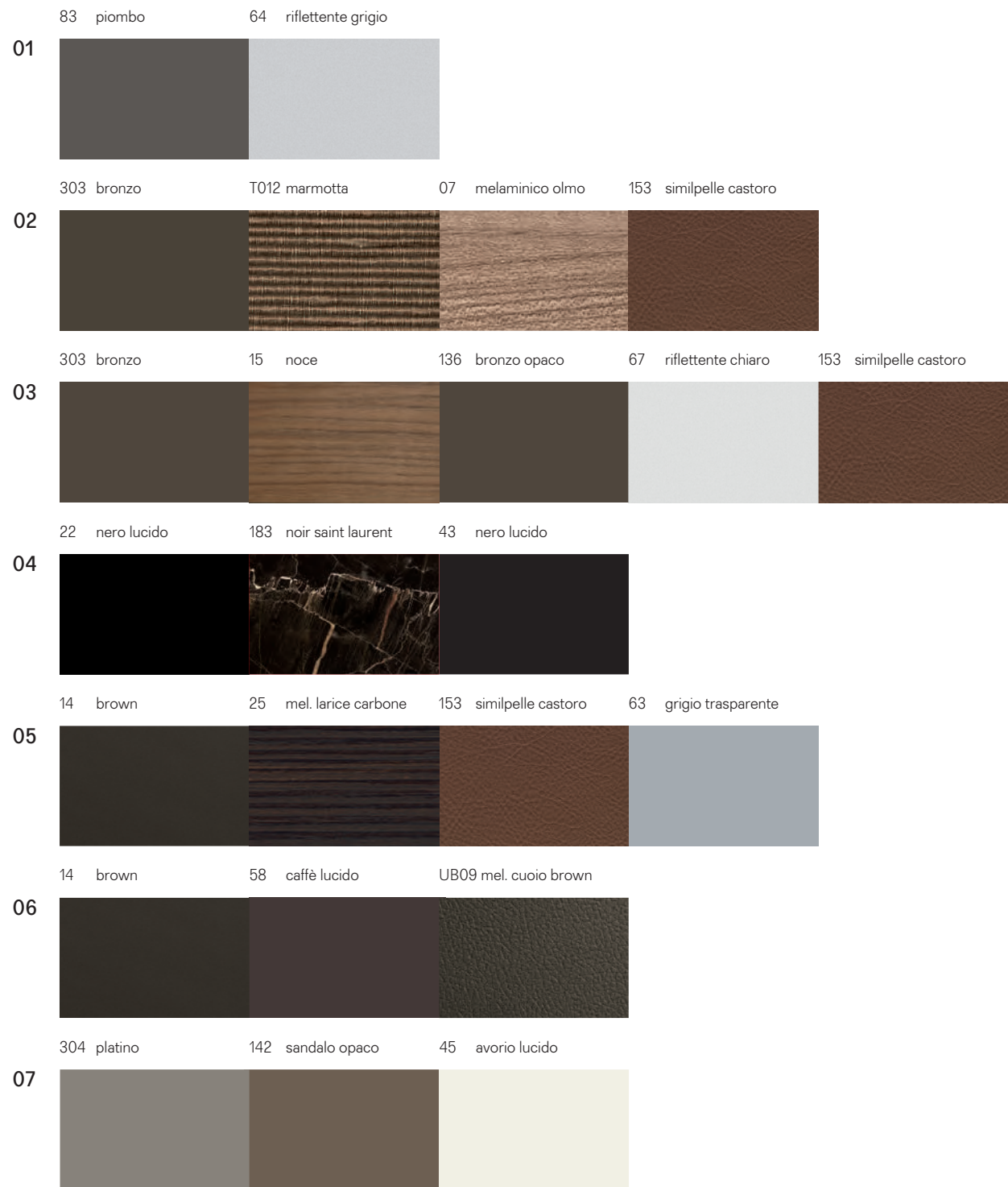

Pianta
Plan

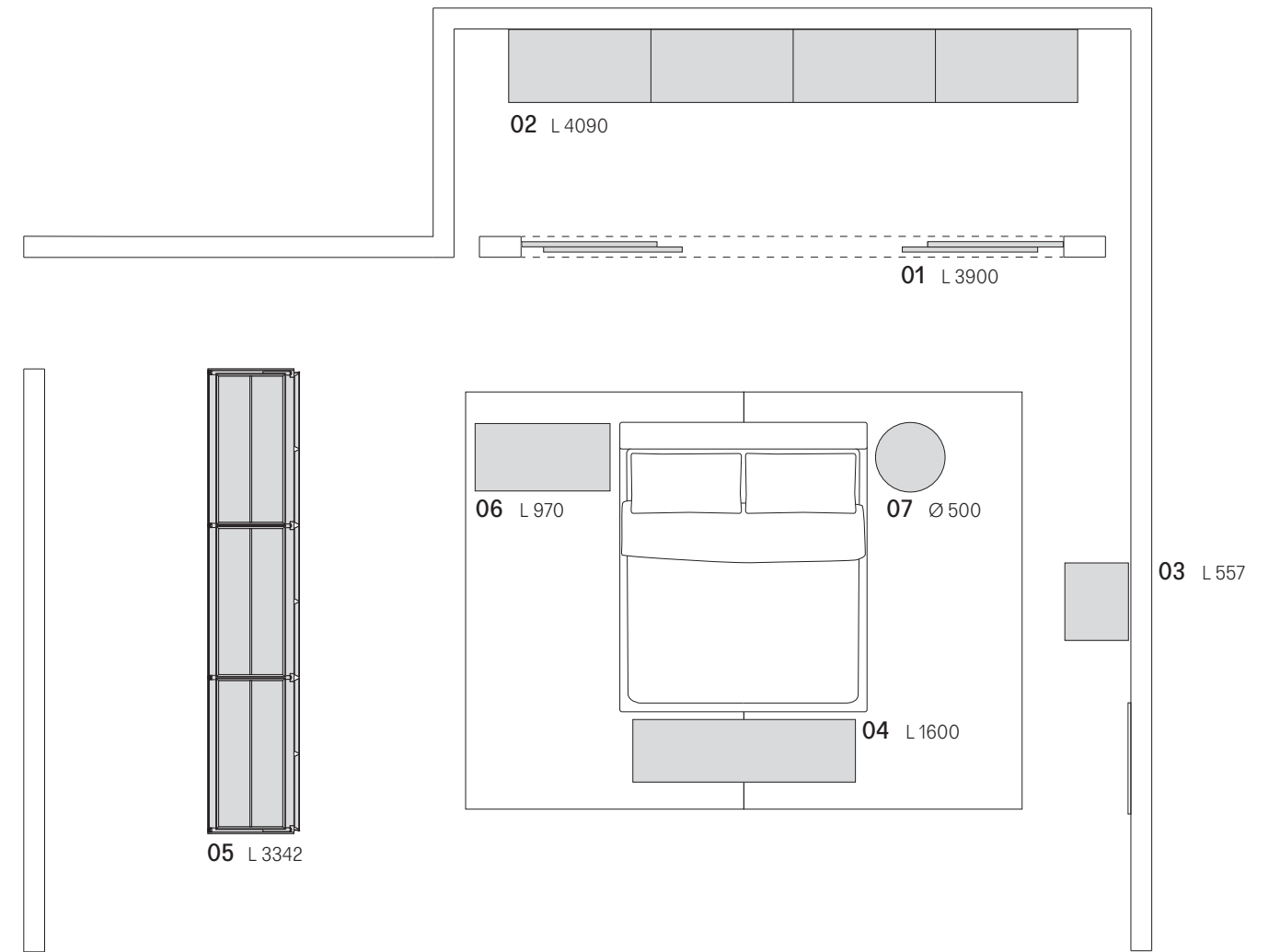



Rimadesio

Rimadesio

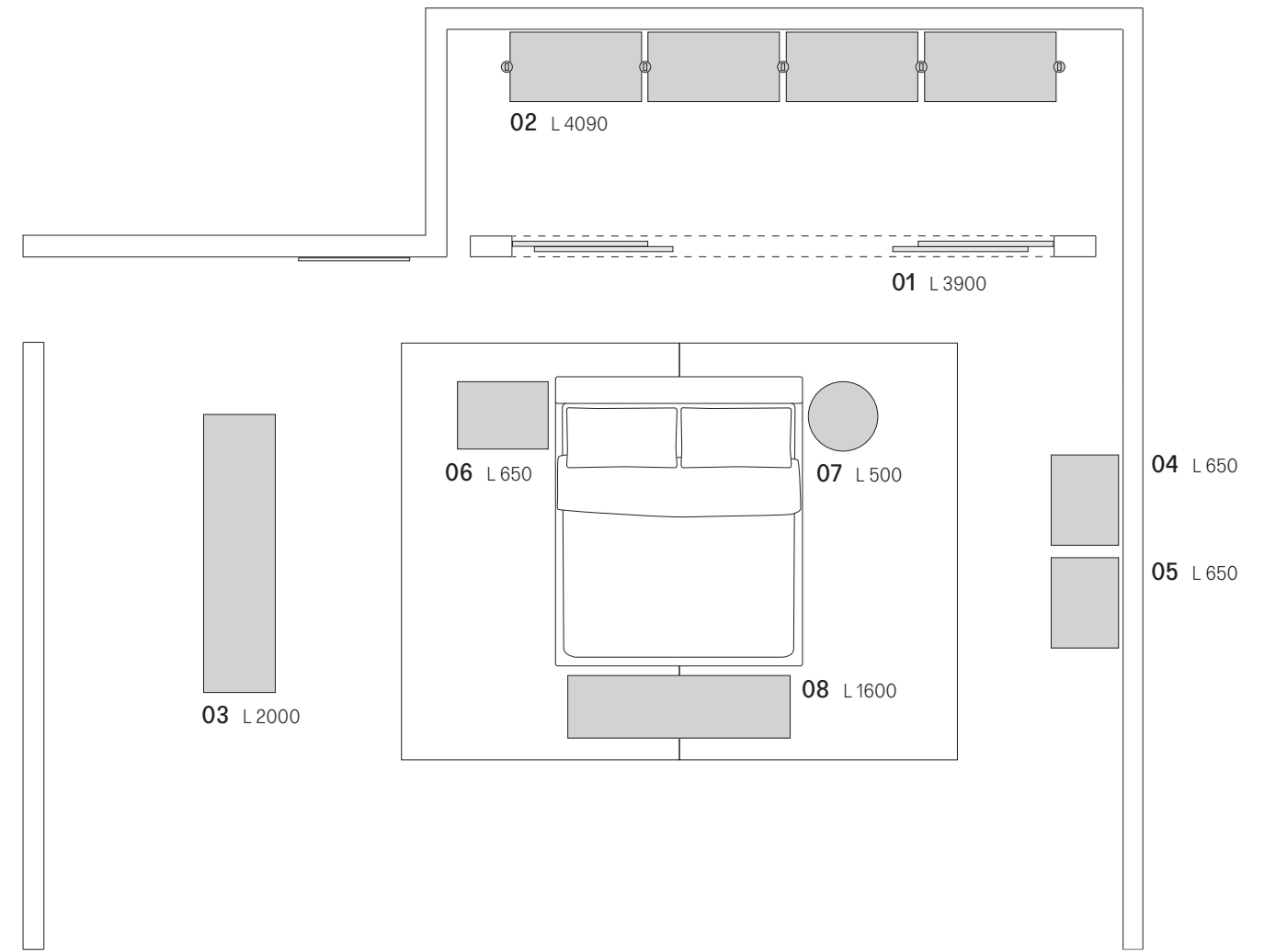
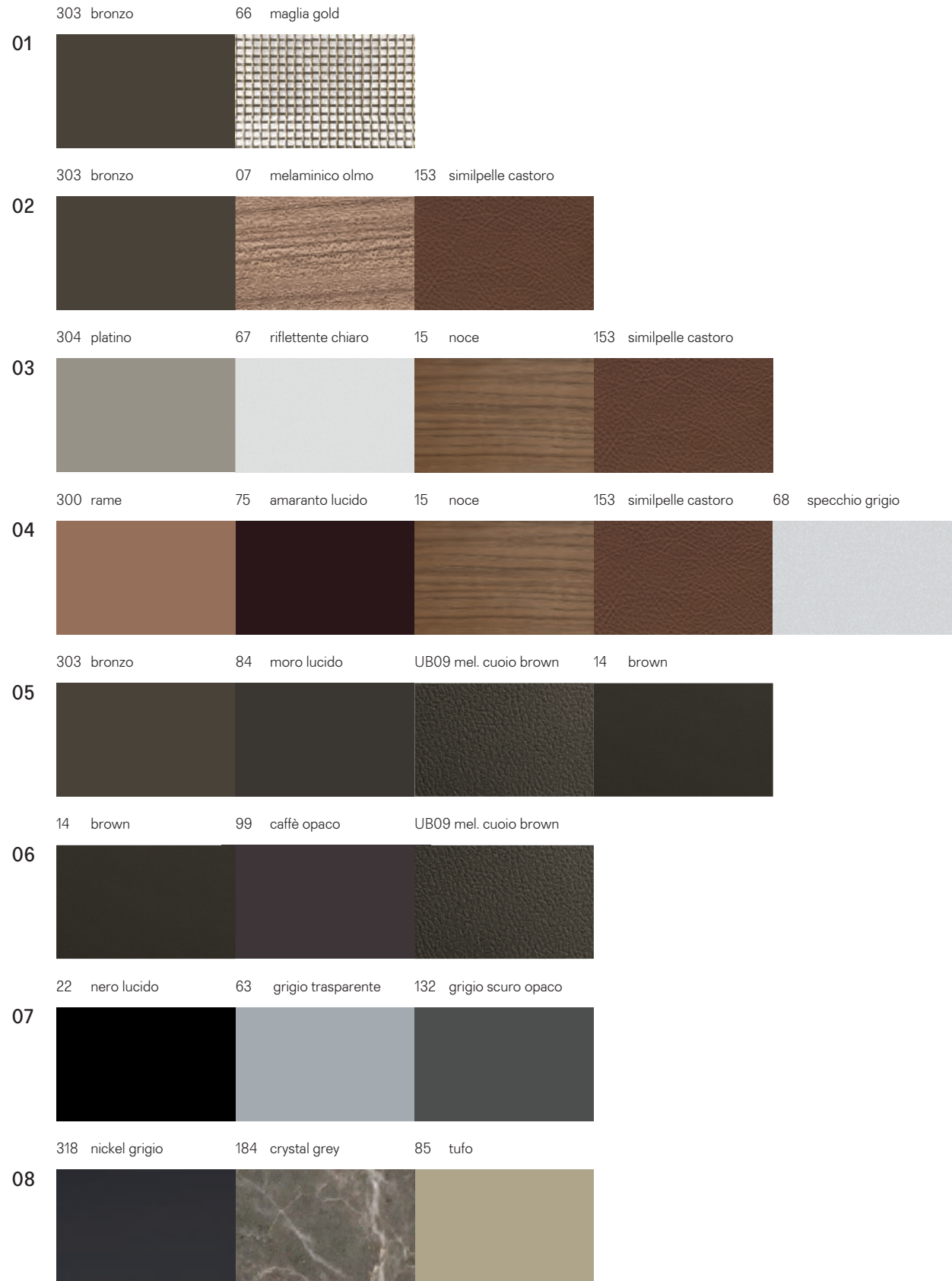

- 01 Velaria
- 02 Zenit
- 03 Alambra
- 04 Self bold secretaire
- 05 Self bold
- 06 Self
- 07 Planet
- 08 Planet



Finiture
Finishings

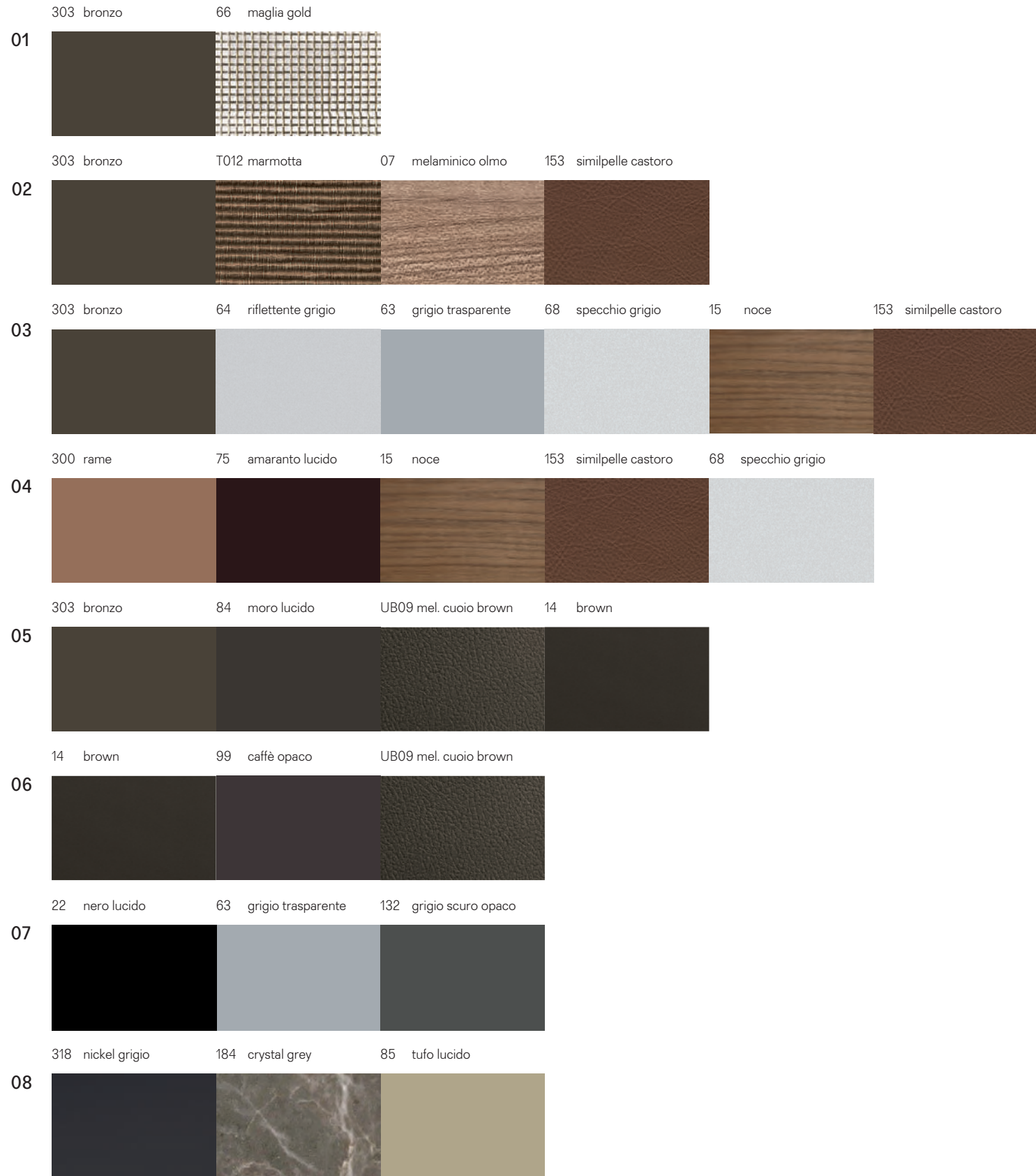

Pianta
Plan

Prodotti
Products

- 01 Velaria
- 02 Dress bold
- 03 Alambra Isola
- 04 Self bold secretaire
- 05 Self bold
- 06 Self
- 07 Planet
- 08 Planet

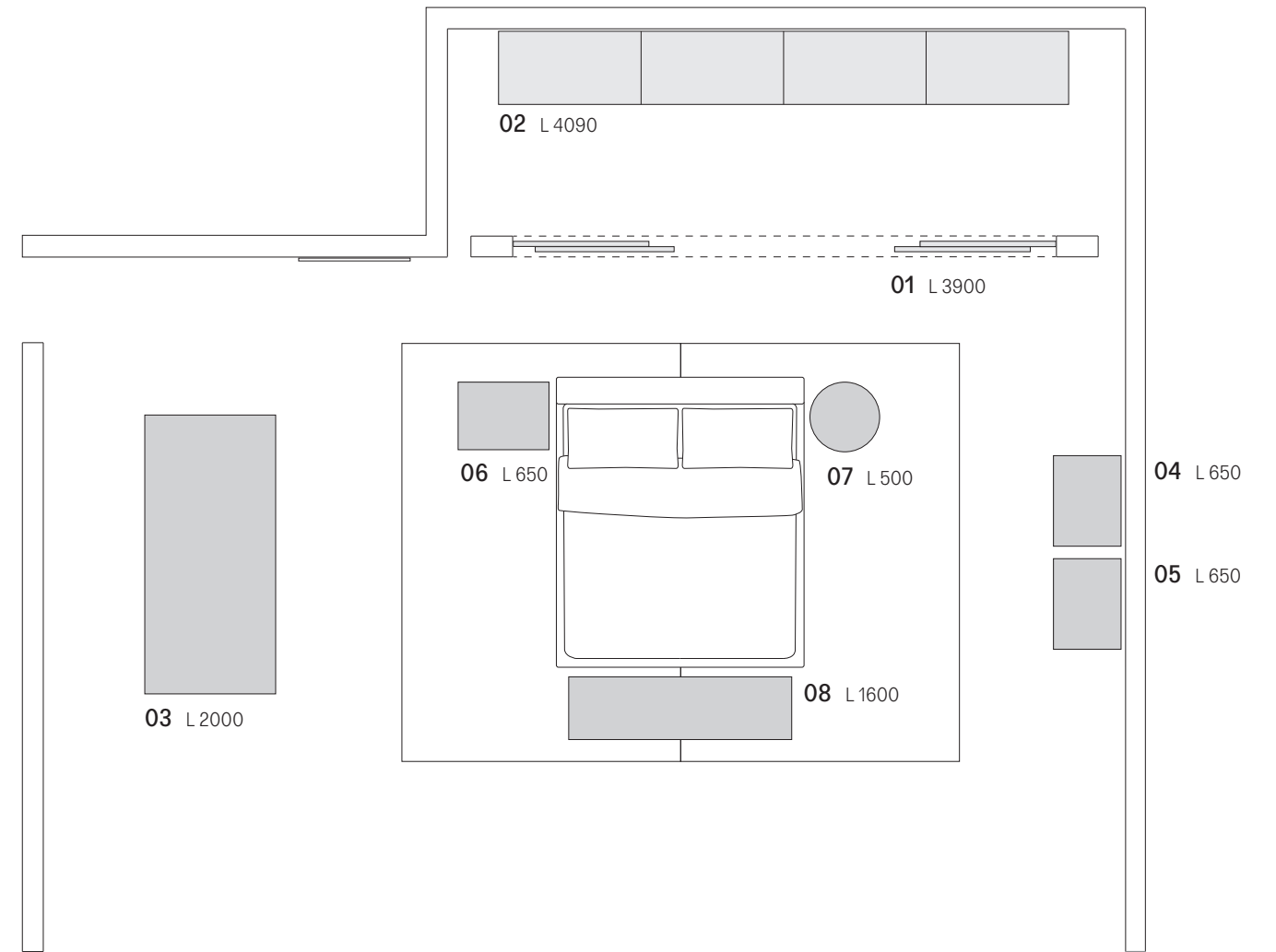



Finiture
Finishings

01 304 platino G001 crema 09 mel. rovere grigio 154 simipelle argilla 14 brown



02 303 bronzo 64 riflettente grigio 07 melaminico olmo 153 simipelle castoro 63 grigio trasparente

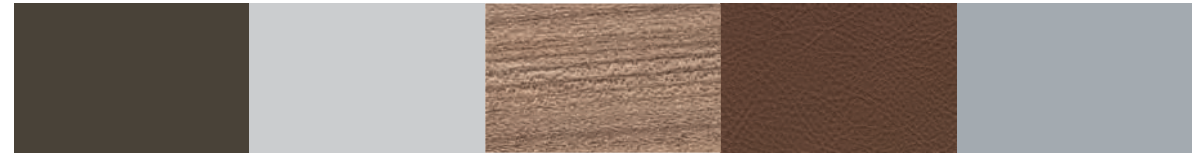

03 58 caffè UB09 mel. cuoio brown 58 caffè lucido



04 30 alluminio 600 grigio artico opaco UB07 mel. cuoio grigio



05 303 bronzo 67 riflettente chiaro 15 noce 68 specchio grigio 153 simipelle castoro 63 grigio trasparente



06 31 alluminio lucido 28 calacatta 85 tufo lucido



07 303 bronzo 84 moro opaco 136 bronzo opaco UB09 mel. cuoio brown



08 303 bronzo 183 noir saint laurent 84 moro lucido

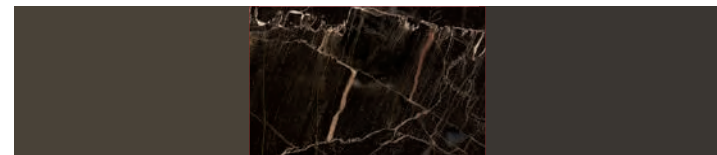

Pianta
Plan

Prodotti
Products

- 01 Cover
- 02 Cover freestanding
- 03 Self
- 04 Self
- 05 Alambra Isola
- 06 Planet
- 07 Self bold
- 08 Planet

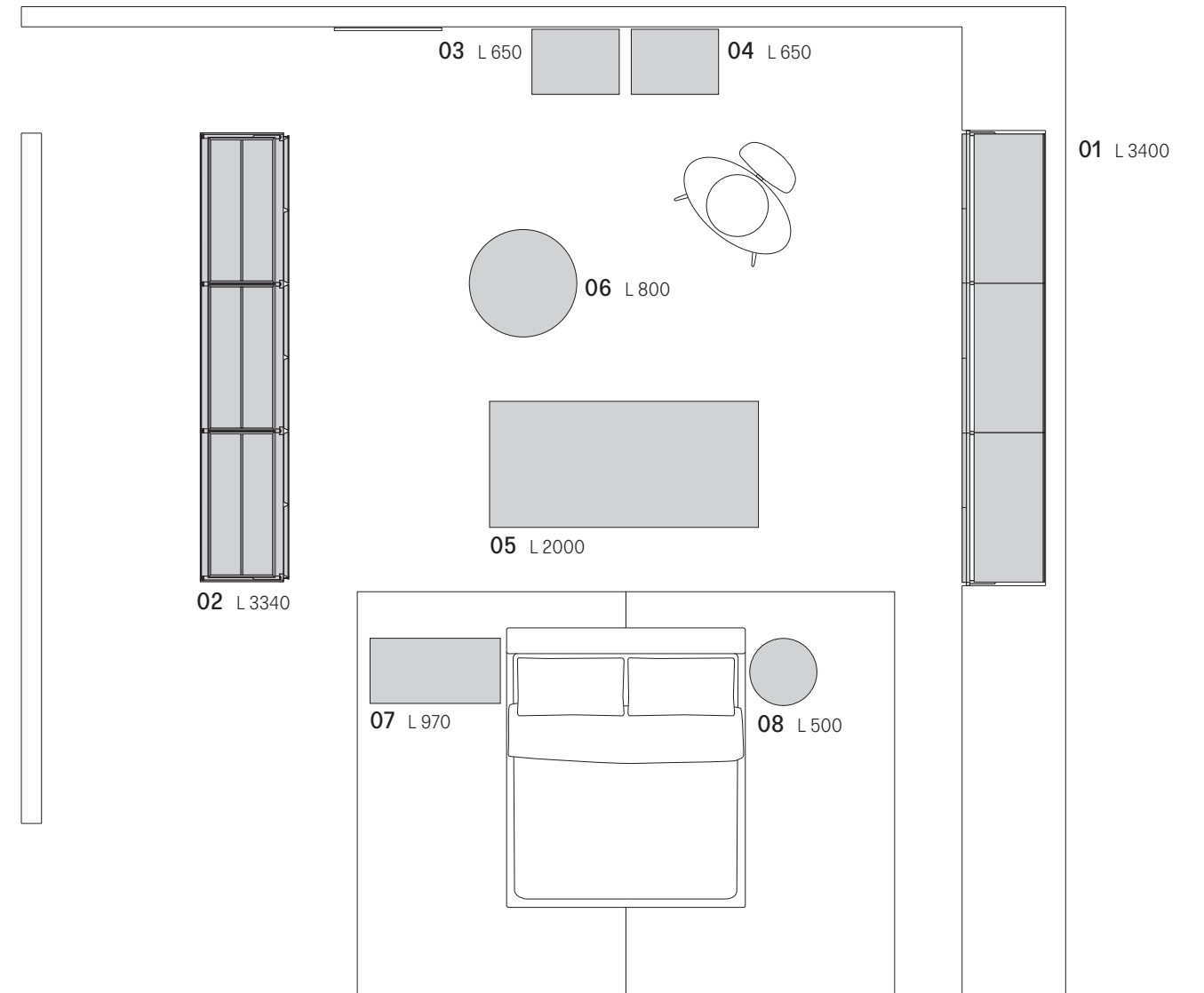



Finiture
Finishings

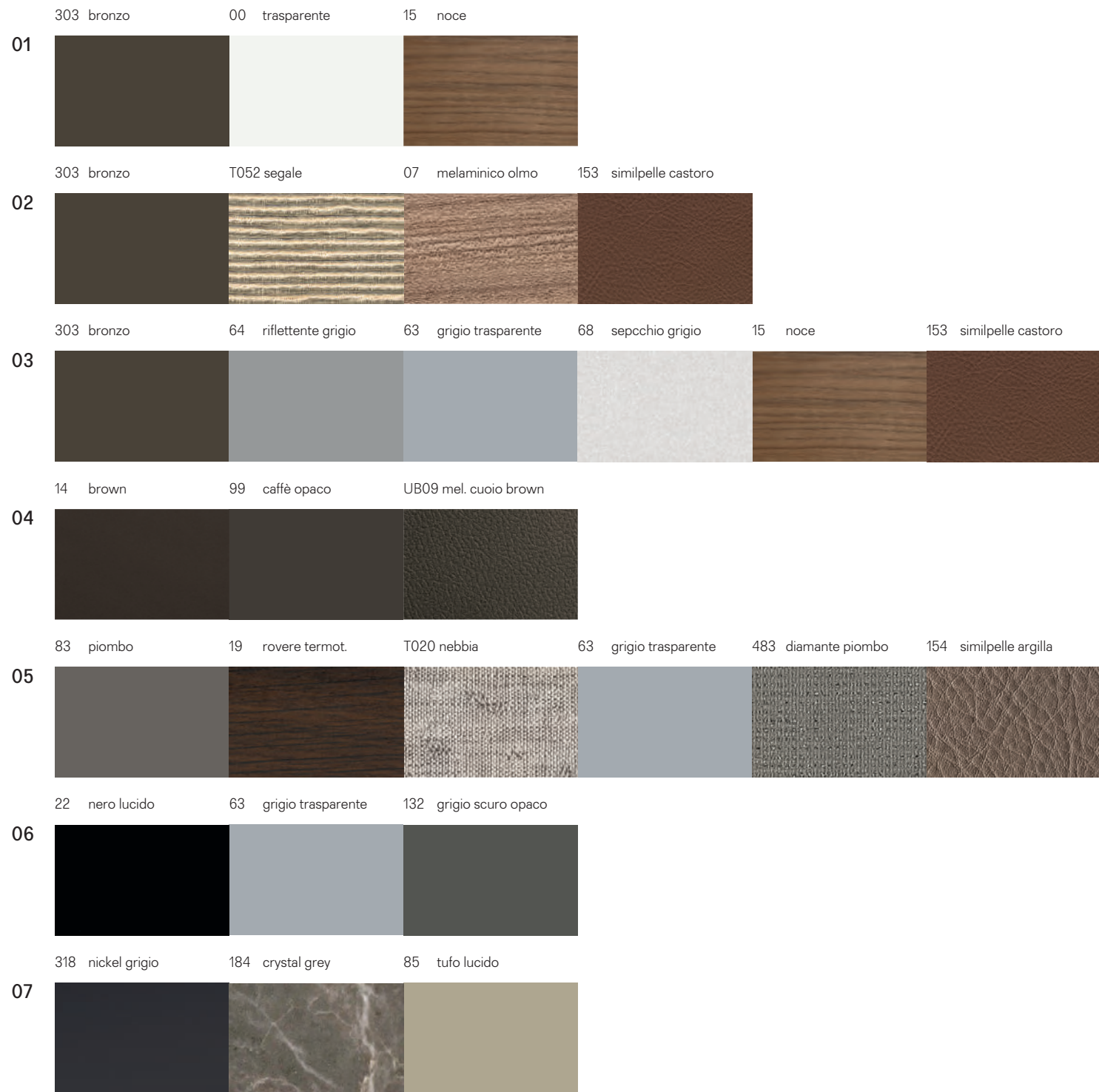

Pianta
Plan

Prodotti
Products

- 01 Spazio Sail
- 02 Dress bold
- 03 Alambra Isola
- 04 Self
- 05 Vanity, Cover
- 06 Planet
- 07 Planet

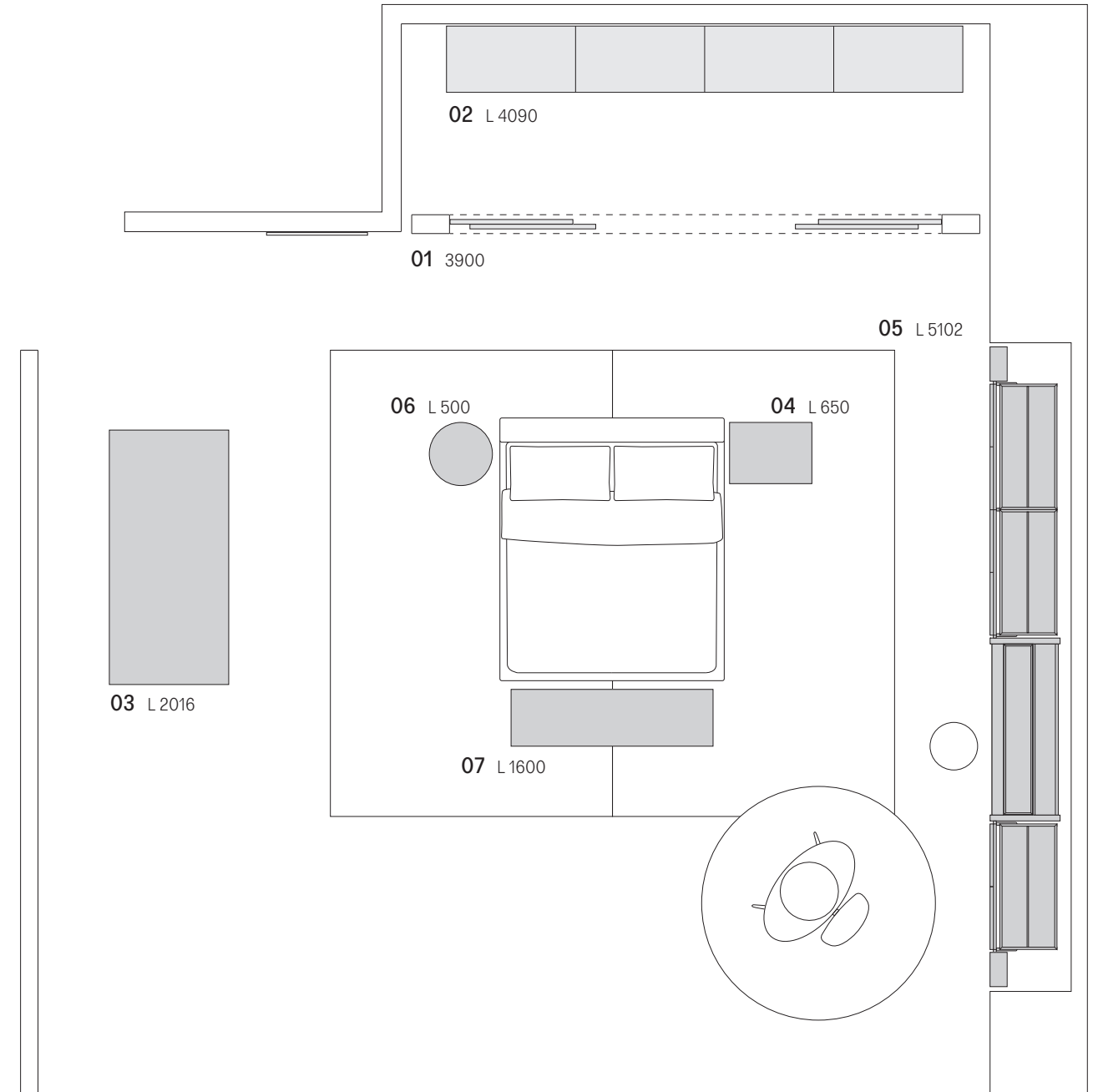



Rimadesio

Finiture
Finishings

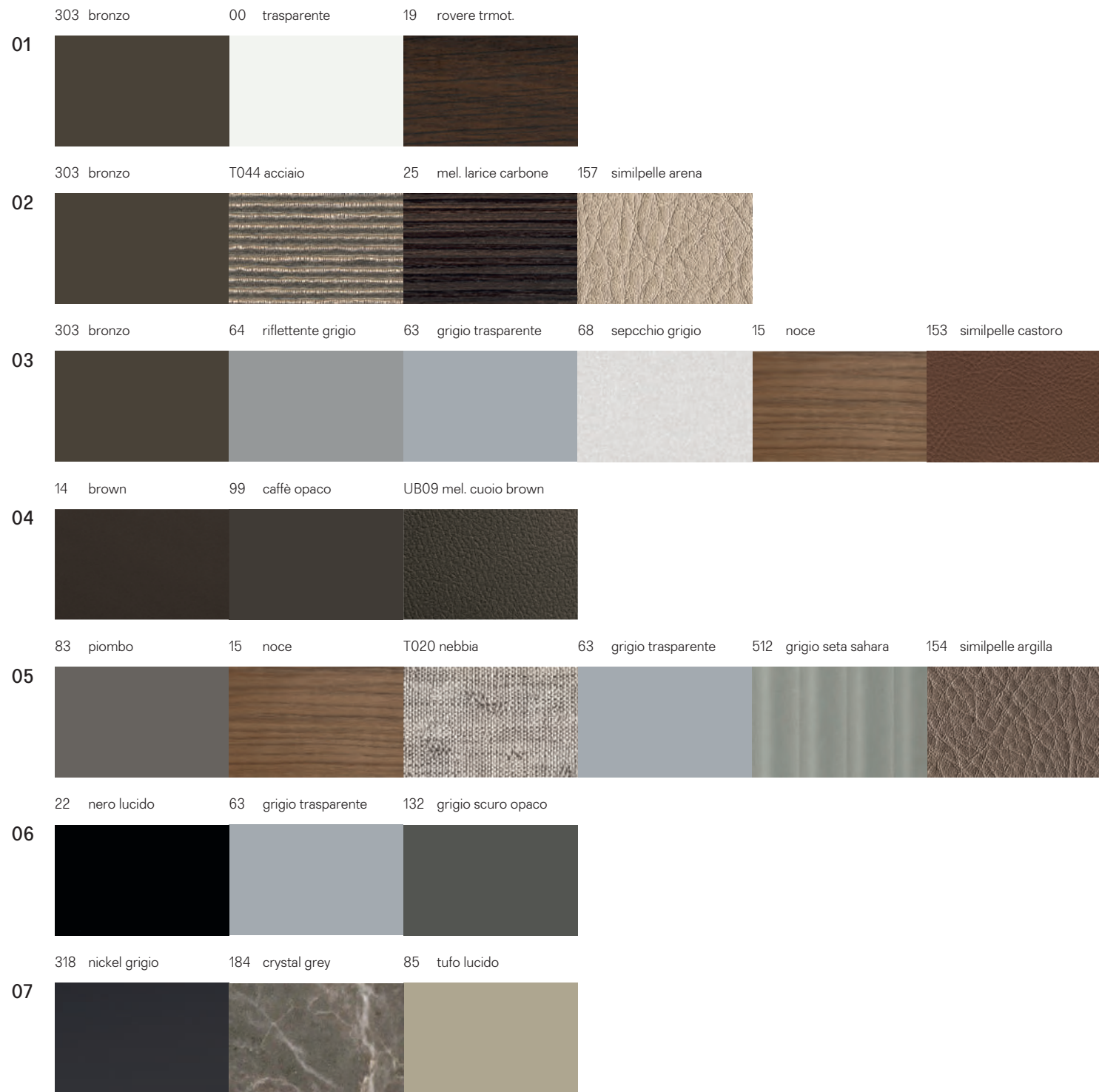

Pianta
Plan

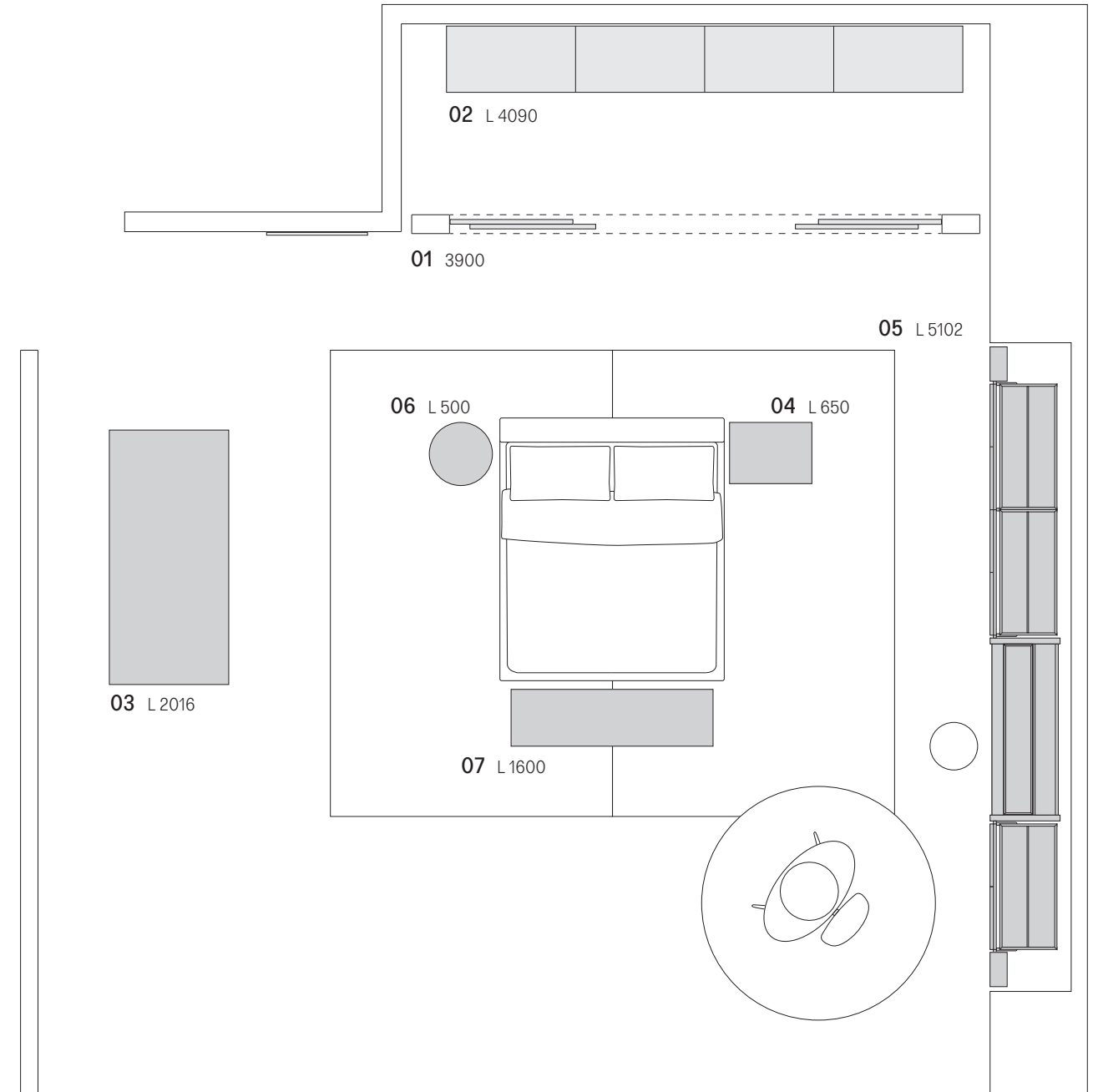

Prodotti
Products

- 01 Spazio Sail
- 02 Dress bold
- 03 Alambra Isola
- 04 Self
- 05 Vanity, Cover
- 06 Planet
- 07 Planet



83 piombo 20 rovere termot. sahara 25 mel. larice carbone 154 similpelle argilla 63 grigio trasparente



83 piombo 63 grigio trasparente 09 mel. rovere grigio 154 similpelle argilla

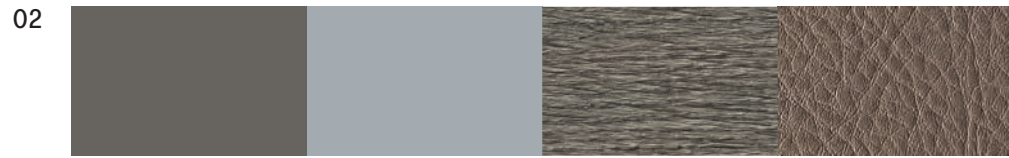

303 bronzo 61 rete inox



T052 segale 07 melaminico olmo 153 similpelle castoro

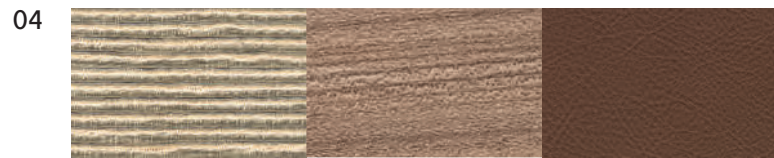

303 bronzo 64 riflettente grigio 63 grigio trasparente 68 specchio grigio 15 noce 153 similpelle castoro



303 bronzo UB09 mel. cuoio brown 136 bronzo opaco



304 platino 63 grigio trasparente 85 tufo lucido



- 01 Modulor
- 02 Zenit
- 03 Velaria
- 04 Dress bold
- 05 Alambra Isola
- 06 Planet
- 07 Self bold

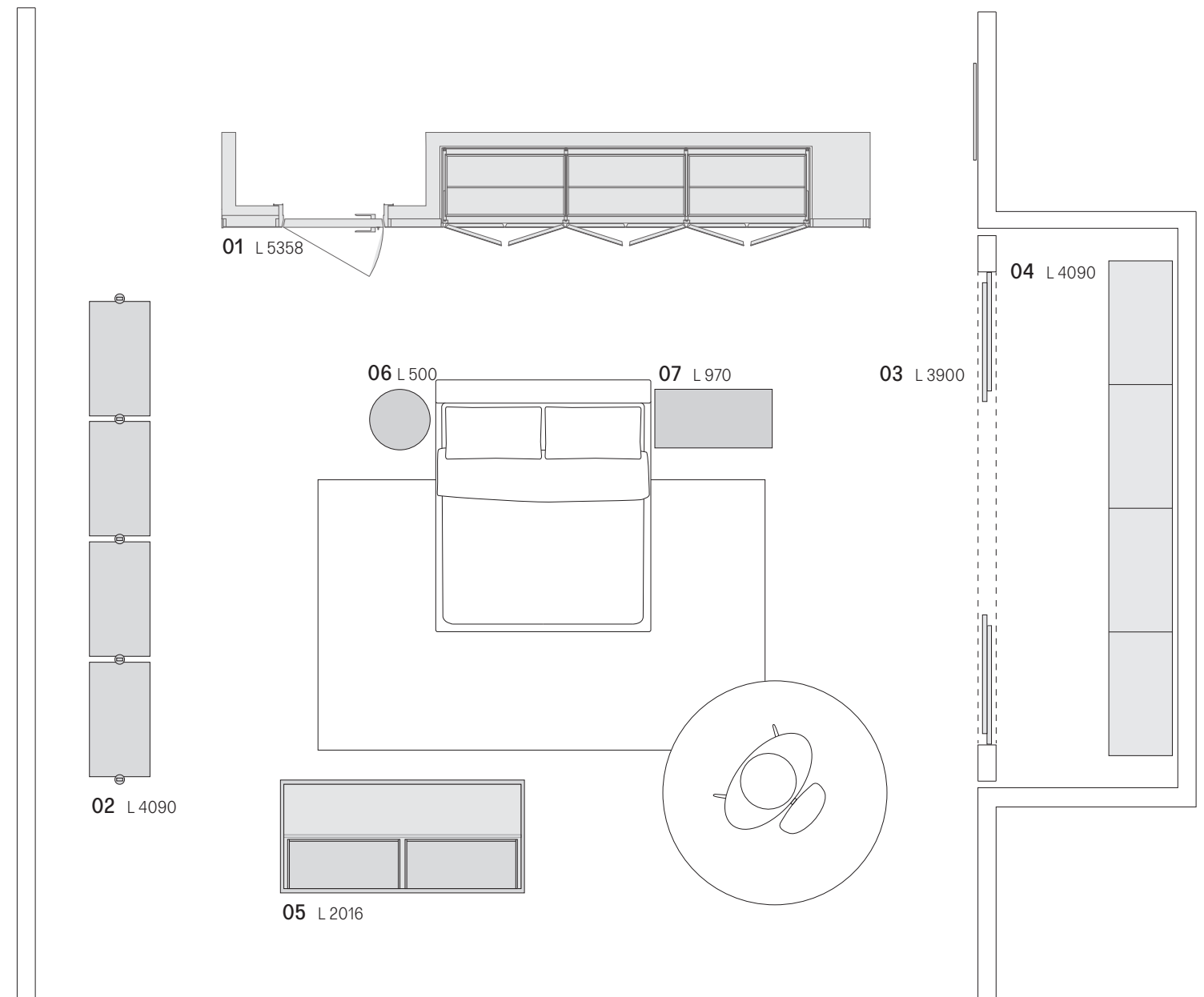



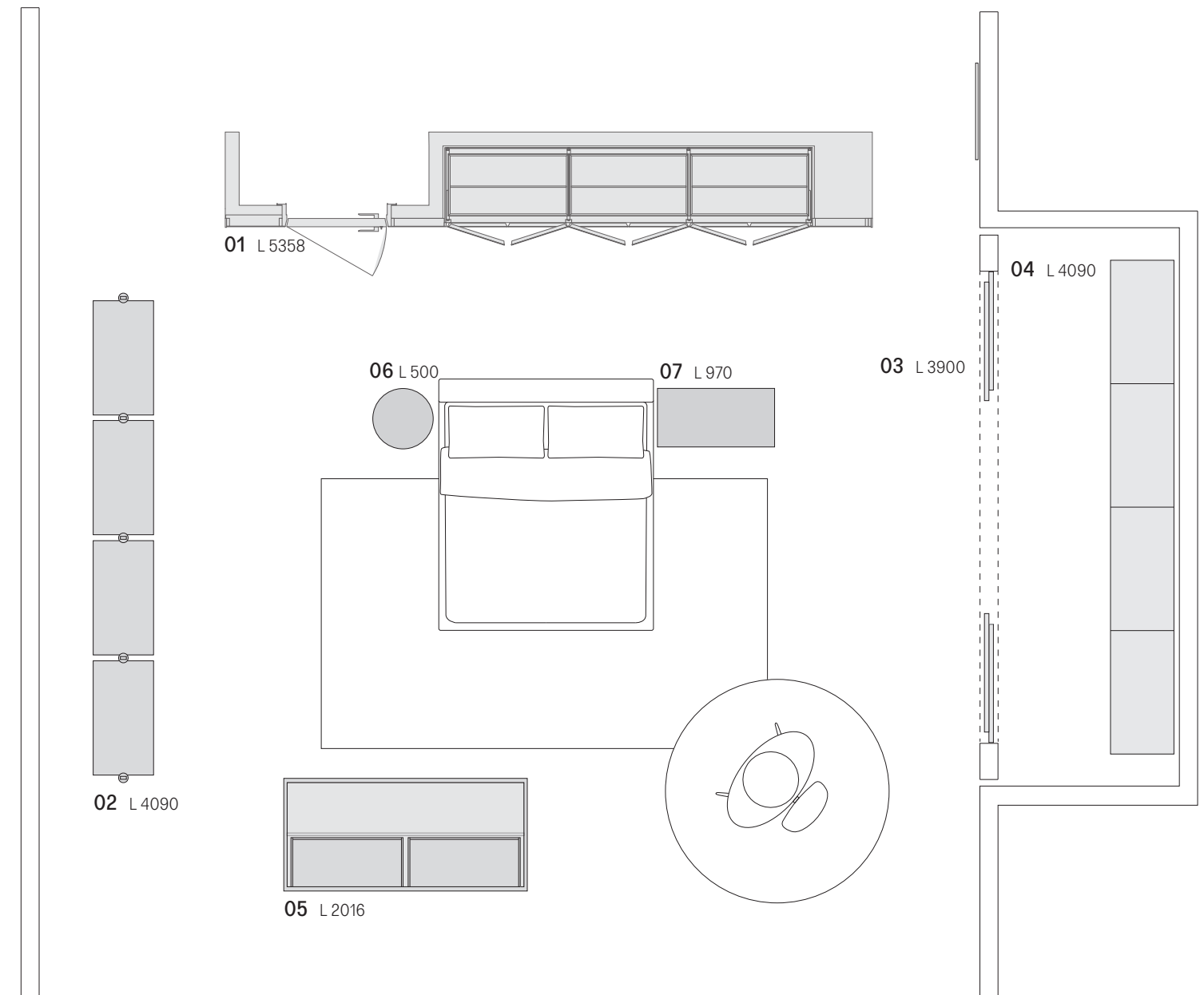
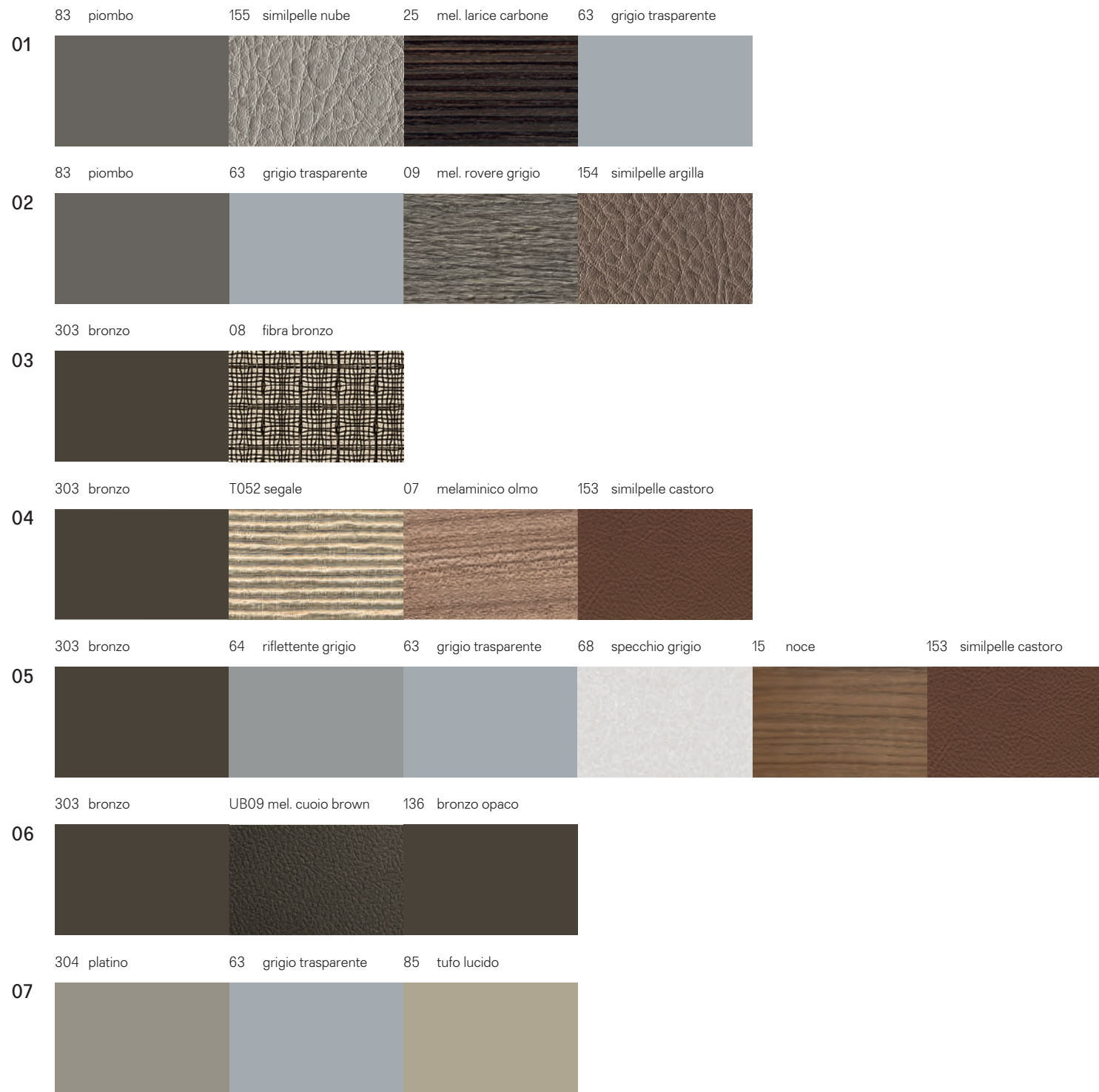

Collection designed by Giuseppe Bavuso

Art direction: Paolo Mojoli
Graphic project: Luma
Styling: Rossella Ballabio
Paper sculptures: Yoko Miura
September 2021

Thanks to:
Amini Carpets, Carl Hansen & Søn

Rimadesio spa
Via Furlanelli 96
20833 Giussano (MB) Italy
T +39 0362 3171
F +39 0362 317317
rimadesio@rimadesio.it

Milano Flagship store
via Visconti di Modrone 26
20122 Milano Italy
T-F +39 02 76280708
milano@rimadesio.it

London Flagship store
83-85, Wigmore street
1WU 1DL London
T +44 2074 862193
london@rimadesio.co.uk

www.rimadesio.it

Italy showroom:
Milano, Roma, Genova, Torino, Como, Brescia, Parma, Firenze,
Palermo, Catania, Cosenza, Salerno.

Worldwide showroom:
Oxford, Genève, Lucerne, Wien, Hamburg, Munich, Nice, Madrid, Barcelona,
Bilbao, Marbella, Teulada-Moraira, Valencia, Vigo, Bruxelles, Moscow,
Saint Petersburg, Istanbul, Kiev, Odessa, Beirut, Nicosia, Tokyo, Seoul, Shanghai,
Beijing, Hangzhou, Hong Kong, Singapore, Manila, Hyderabad, New Delhi, Bangalore,
Houston, New York, Miami, Mexico City, Santiago del Chile, Bogotá, Cape Town,
Casablanca, Riyad, Sydney.

Follow us on Facebook, Instagram

Awards

1993	Siparium	Young & Design
2000	Zenit	Award KBB
2001	Zenit	selection Design Index ADI
2002	Siparium	Top100 Frames
2005	Graphis	selection Design Index ADI
2007	Vela	selection Design Index ADI
2008	Vela	mention XXI Premio Compasso d'Oro ADI
2015	Wind	winner Red Dot Award
2016	Cover	Best Furniture System AZ Award
2016	Alambra	selection Design Index ADI
2017	Sail	selection Design Index ADI
2017	Soho	Architectural products AZ awards
2017	Daimon	Interior Design Magazine Best of Year awards
2020	Modulor	People's Choice winner AZ Awards
2020	Modulor	Architectural Products Award of Merit AZ Awards
2020	Modulor	selection Design Index ADI

Modelli depositati e brevettati/Patented:
Maxi, Sail, Soho, Velaria, Stripe, Daimon, Graphis, Siparium, Zen,
Zen frame, Moon, Vela, Luxor, Even, Aura, Spin, Link+, Planet, Flat, Alambra, Abacus
living, Self, Cover, Zenit, Dress bold e Abacus.

Marchi registrati/Registered trademarks:
Rimadesio, Ecoloursystem, Litech, Siparium, Velaria, Abacus.